

NR, NR4 60 Hz



In-line Pumps
Bombas in-line



Coverage chart - Campo de aplicaciones

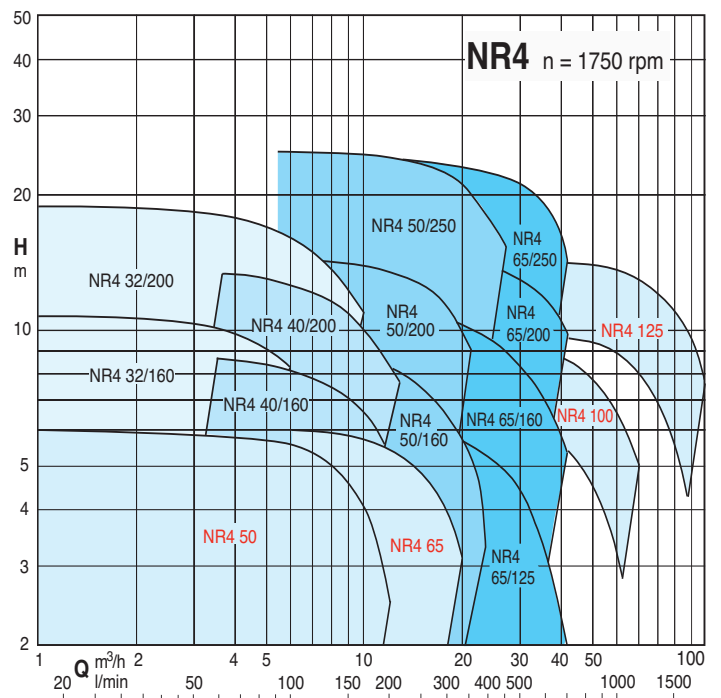
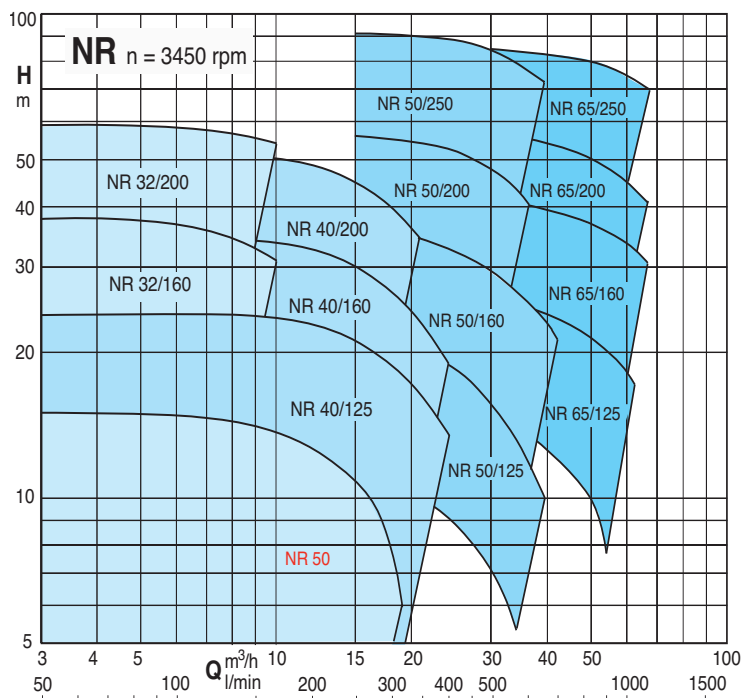

NR, NR4 60 Hz



Construction

Close-coupled, single-impeller, centrifugal pumps; electric motor with extended shaft directly connected to the pump.

Pump casing with suction and delivery connections with the same diameter and on the same axis (in-line).

Connections: Flanges PN 10, EN 1092-2.

Counterflanges (on request)

Sizes	Flanges
NR, NR4 32,40, 50, 65	Screwed flanges PN 16, EN 1092-1
NR4 100, NR4 125	Flanges for welding PN 10, EN 1092-1

Version with frequency converter (on request)

Applications

For clean liquids, without abrasives, which are non-aggressive for the pump materials (contents of solids up to 0.2%).

For heating, conditioning, cooling and circulation plants.

For civil and industrial applications.

When low noise operation is required (n = 1750 rpm).

Operating conditions

Liquid temperature from -10 °C to +90 °C.

Ambient temperature up to 40 °C.

Total suction lift up to 7 m.

Maximum permissible working pressure up to 10 bar.

Continuous duty.

Motor

4-pole induction motor, 60 Hz (n = 1750 rpm).

NR4: three-phase 220/380 V, 220/440 V, up to 3 kW;
380/660 V, for 4 kW;

NRM4: single-phase 110 V, 127 V, 220 V.

2-pole induction motor, 60 Hz (n = 3450 rpm).

NR: three-phase 220/380 V, 220/440 V, up to 3 kW;
380/660 V, from 4 to 18,5 kW;

NRM: single-phase 110 V, 127 V, 220 V.
with thermal protector up to 1.1 kW only 220V.

Classification scheme IE3 for three-phase motors from 0,75 kW.

Insulation class F.

Protection IP 54.

Motor suitable for operation with frequency converter from 0,75 kW for NR4 and from 1,1 kW for NR.

Constructed in accordance with EN 60034-1, EN 60034-30-1,
EN 60335-1, EN 60335-2-41.

Special features on request

- Other voltages.
- Protection IP 55.
- Special mechanical seal.
- Higher or lower liquid or ambient temperatures.
- Motor suitable for operation with frequency converter up to 0,55 kW for NR4 and up to 0,75 kW for NR.

Materials

Component	Material
Pump casing Lantern bracket	Cast iron GJL 200 EN 1561
Impeller	Cast iron GJL 200 EN 1561 (Brass P-Cu Zn 40 Pb 2 UNI 5705 for NR-NR4 32,40,50)
Shaft	Cr Ni steel AISI 303 up to 1.1 kW Cr steel AISI 430 from 1.5 to 18,5 kW
Mechanical seal	Carbon - Ceramic - NBR
Counterflanges	Steel Fe 430B UNI 7070

Ejecución

Electrobomba centrífuga, con un solo rodete, monobloc con acoplamiento directo motor-bomba y eje único.

Cuerpo bomba con orificios de aspiración e impulsión del mismo diámetro y dispuestos sobre el mismo eje (ejecución "in-line").

Conexiones: Bridas PN 10, EN 1092-2.

Contrabridas (bajo demanda)

Dimensiones	Bridas
NR, NR4 32,40,50,65	Bridas roscadas PN 16, EN 1092-1
NR4 100, NR4 125	Bridas a soldar por aportación PN 10, EN 1092-1

Versión con variador de frecuencia (bajo demanda)

Aplicaciones

Para líquidos limpios sin partes abrasivas, y no agresivos para los materiales de la bomba (con partes solidas hasta 0,2% max).

Instalaciones de calefacción, acondicionamiento, refrigeración, recirculación en circuitos cerrados, etc.

Para aplicaciones civiles e industriales.

Cuando es particularmente requerido un funcionamiento con bajo nivel de rumorosidad (n = 1750 1/min).

Limites de empleo

Temperatura líquido: de -10 °C a +90 °C.

Temperatura ambiente hasta 40 °C.

Altura de aspiración manométrica hasta 7 m.

Presión máxima admitida en el cuerpo de la bomba 10 bar.

Servicio continuo.

Motor

Motor a inducción a 4 polos, 60 Hz (n = 1750 1/min).

NR4: trifásico 220/380 V, 220/440 V, hasta 3 kW;
380/660 V, para 4 kW.

NR4M: monofásico 110 V, 127 V, 220 V.

Motor a inducción a 2 polos, 60 Hz (n = 3450 1/min).

NR: trifásico 220/380 V, 220/440 V, hasta 3 kW;
380/660 V, de 4 a 18,5 kW.

NRM: monofásico 110 V, 127 V, 220 V.
con protector térmico hasta 1,1 kW sólo para 220V.

Clase alta eficiencia IE3 para motor trifásico de 0,75 kW.

Aislamiento clase F.

Protección IP 54.

Motor preparado al funcionamiento con convertidor de frecuencia de 0,75 kW para NR4 y 1,1 kW para NR.

Ejecución según EN 60034-1; EN 60034-30-1,
EN 60335-1, EN 60335-2-41.

Ejecuciones especiales bajo demanda

- Otras tensiones.
- Protección IP 55.
- Sello mecánico especial.
- Para líquidos o ambientes con temperaturas más elevadas o más bajas.
- Motor preparado al funcionamiento con convertidor de frecuencia hasta 0,55 kW para NR4 y 0,75 kW para NR.

Materiales

Componente	Materiale
Cuerpo bomba Acoplamiento	Hierro GJL 200 EN 1561
Rodete	Hierro GJL 200 EN 1561 (Latón P-Cu Zn 40 Pb 2 UNI 5705 para NR-NR4 32,40,50)
Eje	Acero al Cr Ni AISI 303 hasta 1,1 kW Acero AISI 430 de 1,5 a 18,5 kW
Sello mecánico	Carbón - Cerámica - NBR
Contrabridas	Acero Fe 430B UNI 7070

NR EI 60 Hz



Pumps with frequency converter

The **NR EI, NR4 EI**, pumps are available with power from 0,25 kW up to 18,5 kW, the pumps are equipped with **I-MAT** installed on board which allows to realize a variable-speed system extremely compact and efficient, ideal in applications of water supply and in the distribution of hot and cold water.

The pump is equipped with transducers suitable for operation and is already programmed at the factory.

Advantages

- Energy saving
- Compact design
- Easy to use
- Programmable to suit the system requirements
- Reliability

Costruction

The system comprises of:

- Pump
- Induction motor
- I-MAT Frequency converter
- Motor adapter for the motor mounting of the frequency converter
- Connection cable between frequency converter and induction motor
- Transducers



Main features

- Rated motor power output from 0,25 kW to 18,5 kW
- Control range from 1750 to 3450 rpm (2-pole)
- Control range from 870 to 1750 rpm (4-pole)
- Protection against dry running
- Protection against operations with closed valve ports
- Protection against system leakages
- Protection against overcurrent in the motor
- Protection against overvoltage and undervoltage of the power supply
- Protection against current unbalances between phases

Bomba a velocidad variable

La bomba **NR EI, NR4 EI**, se encuentra disponible con potencias de 0,25 kW a 18,5 kW y llevan incorporado un variador **I-MAT** que permite realizar un sistema de velocidad variable extremadamente compacto y eficiente, ideal para aplicaciones de abastecimiento de agua y la distribución de agua fría y caliente.

Bomba eléctrica es suministrada con un transductor de presión idóneo para el modo operación que escoja el cliente y programado directamente desde fábrica

Ventajas

- Ahorro de energía
- Diseño compacto
- Fácil de usar
- Programable para las necesidades del sistema
- Fiabilidad

Construcción

- El sistema está compuesto por:
- Bomba
- Motor de inducción
- I-MAT variador de frecuencia
- Adaptador del motor para el montaje del variador de frecuencia
- Cable de conexión entre en variador y la bomba eléctrica
- Transductores

Límites de utilización

- Potencia nominal del motor desde 0,25 kW hasta 18,5 kW
- Rango de control desde 1750 hasta 3450 rpm (2 polos)
- Rango de control desde 870 hasta 1750 rpm (4 polos)
- Protección contra el funcionamiento en seco
- Protección contra el funcionamiento con válvula cerrada
- Protección contra fugas del sistema
- Protección contra sobrecorriente del motor
- Protección contra sobrevoltaje o bajovoltaje de la red de alimentación
- Protección contra el desequilibrio de fases

Operating modes



Constant pressure mode
with pressure transducer

In this mode, the system maintains the preset pressure when the flow required by the installation changes.

Modos de operación

Modo presión constante
con sensor de presión

En el modo de presión constante, el sistema mantiene la presión prefijada cuando cambia el caudal por los cambios de la instalación.

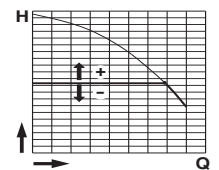

Proportional pressure mode
with pressure transducer

In this mode the system changes the working pressure according to the required flow rate.

Modo presión proporcional
con sensor de presión

En el modo de presión proporcional, el sistema cambia la presión de trabajo de acuerdo al caudal requerido.

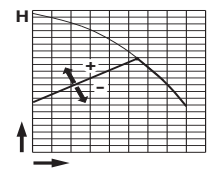

Constant flow mode
with flow meter

In this mode the system maintains a constant flow rate value in a point of the installation according to the required pressure.

Modo caudal constante
con medidor de caudal

En el modo caudal constante el sistema mantiene el caudal constante en un punto de la instalación de acuerdo a la presión requerida.

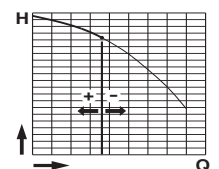

Fixed speed mode
with setting of the speed preferential rotation.

In this mode, by changing the working frequency, you may choose any operational curve included within the working range.

Modo velocidad fija
con el ajuste de la velocidad de rotación preferencial

En el modo velocidad fija, cambiando la frecuencia de trabajo, se puede escoger cualquier curva operativa dentro del rango de trabajo de la bomba.

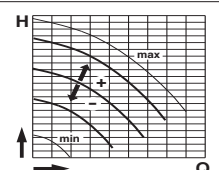

Constant temperature mode
with temperature transducer

In this mode the system keeps the temperature constant inside a system by changing the speed of the pump.

Modo temperatura constante
con sensor de temperatura

En este modo el sistema mantiene la temperatura constante dentro de un sistema cambiando la velocidad de la bomba.

Performance - Prestaciones

n ≈ 3450 rpm

3 ~	1 ~	P ₂		Q m ³ /h															
		kW	HP		l/min														
				0		6	6,6	7,5	8,4	9,6	10,8	12	13,2	15	16,8	18,9			
NR 50D-60/A	NRM 50D-60/A	0,45	0,6	H	12,5	11,7	11,5	11,2	10,8	10	8,8	7,3	5,5						
NR 50C-60/B	NRM 50C-60/A	0,75	1	m	17,7	17,4	17,3	17,1	16,9	16,4	15,7	14,9	13,7	11,5	8,7	4,8			

3 ~		P ₂		Q m ³ /h																		
		kW	HP		l/min																	
				0		2,4	3	3,6	4,8	6	6,6	7,5	8,4	9,6	10,8	12	13,2	15	16,8	18		
NR 32/160B-60/A		1,1	1,5	H m	29,4	29,2	29	28,6	27,8	26,9	26,4	25,5	24,4	22,5	20,1	17						
NR 32/160A-60/A		1,5	2		38,2	37,1	37,9	37,5	36,7	35,8	35,3	34,5	33,6	32,3	30,5	28,4						
NR 32/200B-60/A		2,2	3		44,4	43,7	43,5	43,2	42,5	41,6	41,2	40,4	39,5	38,1	36,2	33,6	30,2	24,3				
NR 32/200A-60		3	4		52	51,6	51,4	51,1	50,5	49,7	49,3	48,5	47,8	46,6	45,2	43,4	40,9	35,9	29,2			
NR 32/200S-60/A		4	5,5		60	59,6	59,5	59,3	58,8	58	57,5	56,8	56	54,9	53,7	52,3	50,7	47,2	42,1	37,7		

3 ~		P ₂		Q m ³ /h																
		kW	HP		l/min															
				0		6,6	7,5	8,4	9,6	10,8	12	13,2	15	16,8	18,9	21	24			
NR 40/125C-60		0,75	1	H m	16,6	16,3	16,1	15,8	15,3	14,8	14,2	13,5	12	10,2	8	5,4				
NR 40/125B-60/A		1,1	1,5		20,6	20,6	20,4	20,2	19,8	19,3	18,8	18,2	17,1	15,8	13,8	11,4	7,6			
NR 40/125A-60/A		1,5	2		25	25,4	25,3	25	24,7	24,3	23,8	23,2	22,2	21	19,6	17,6	14,2			
NR 40/160B-60/A		1,5	2		29,2	28,5	28,2	27,9	27,4	26,8	26,2	25,5	24,1	22,3	19,7	16,7	11,9			
NR 40/160A-60/A		2,2	3		37,5	36,5	36,1	35,8	35,2	34,6	33,9	33,2	31,9	30,5	28,4	25,8	21			
NR 40/200B-60		3	4		43,4	41,2	40,7	39,4	39,4	38,5	37,4	36,1	33,4	29,7	25,1	20				
NR 40/200A-60/A		4	5,5		54,9	52,3	51,8	50,5	50,5	49,7	48,7	47,6	45,8	43,4	39,3	34,5				

3 ~		P ₂		Q m ³ /h																
		kW	HP		l/min															
				0		15	16,8	18,9	21	24	27	30	33	37,8	39	42	45			
NR 50/125F-60/A		1,1	1,5	H m	15,2	14,7	14,2	13,4	12,5	11,1	9,5	7,6	5,5							
NR 50/125C-60/A		1,5	2		17,9	17,8	17,3	16,7	15,9	14,7	13,4	11,8	10,1							
NR 50/125A-60/B		2,2	3		21,3	21,7	21,4	20,9	20,4	19,4	18,3	17	15,6	13	12,2*					
NR 50/160C-60/B		2,2	3		23,1	24,4	23,9	23,1	22,2	20,6	19	17,1	14,9	10,7	9,4*					
NR 50/160B-60/A		3	4		29,9	29,9	29,4	28,8	28,1	26,9	25,5	23,9	22,1	18,9	18*					
NR 50/160A-60/B		4	5,5		36,1	36,5	36,1	35,5	34,9	33,7	32,1	30,4	28,6	25,3	24,3*	22*				
NR 50/200C-60/B		4	5,5		48,4	45,4	44,4	43,2	41,7	39,4	37	34								
NR 50/200B-60/A		5,5	7,5		53,4	50,8	50	48,6	47,3	45,4	43,3	40,7	37,5							
NR 50/200A-60/A		7,5	10		60	57,8	57	56	54,8	53	51,1	48,8	46,2	41,4						
NR 50/250C-60/B		9,2	12,5		68,9	65,5	64,5	63,3	62,3	60,3	58,1	55,3	52,5							
NR 50/250B-60/B		11	15		76,4	73,5	72,8	71,5	70,5	68,8	66,8	64,3	61,5	56,9						
NR 50/250A-60/B		15	20		92,6	90,2	89,5	88,6	87,6	86,4	84,5	82,6	80,6	76,7	75,4					

3 ~		P ₂		Q m ³ /h																
		kW	HP		l/min															
				0		21	24	27	30	33	37,8	42	48	54	60	66	69	72	75	84
NR 65/125F-60/B		2,2	3	H m	16,9	16,7	16,3	15,9	15,3	14,6	13,4	12,2	10,1	7,6*	4,8*					
NR 65/125D-60/A		3	4		19,7	19,7	19,4	19	18,6	18	17	16	14,3	12,2*	9,8*					
NR 65/125A-60/B		4	5,5		24,3	24,7	24,6	24,3	24	23,7	22,9	22,2	20,9	19*	17,6*					
NR 65/160B-60/A		5,5	7,5		34,8	35,5	35,1	34,7	34,3	33,8	32,6	31,5	29,2	26,7	23,7*					
NR 65/160A-60/A		7,5	10		41	41,8	41,6	41,4	41	40,6	39,8	38,9	37,3	35,4	32,8*	30,1*				
NR 65/200B-60/B		9,2	12,5		51,2	50,5	49,9	49,1	48,3	47,3	45,4	43,9	41,5	38,6	35,1	30,9				
NR 65/200A-60/B		11	15		57,6	57,4	57	56,2	55,5	54,5	52,9	51,4	49,1	46,8	43,9	40,5				
NR 65/250C-60/B		11	15		63,2	63	62,3	61,5	60,6	59,6	57,6	55,6	52,8	49,4						
NR 65/250B-60/B		15	20		73,1	73,4	72,8	72,3	71,5	70,8	69,1	67,4	64,8	61,8	58,4					
NR 65/250A-60/C		18,5	25		85,3	86,1	85,7	85,3	84,8	84	82,5	81,2	79	76,5	73,6	70,3				

P₂ Rated motor power output.
Potencia nominal del motor.

H Total head in m.
Altura total en m.

Tolerances according to UNI EN ISO 9906:2012.
Tolerancias según UNI EN ISO 9906:2012.

Performance - Prestaciones

n ≈ 1750 rpm

3 ~	1 ~	P ₂		Q m ³ /h																
		kW	HP																	
						l/min	0	2	4	6	8	10	12	14	16	18	20	25		
NR4 50C-60/A	NR4M 50C-60/A	0,25	0,34	H m	3,9	4	3,9	3,7	2,7											
NR4 50B-60/A	NR4M 50B-60/A	0,25	0,34		4,7	5	4,9	4,7	3,8	2,5										
NR4 50A-60/A	NR4M 50A-60/A	0,25	0,34		5,6	6	5,9	5,8	5,2	4,1	2,6									
NR4 65C-60/A	NR4M 65C-60/A	0,25	0,34		3,8			4,2	4,2	4	3,6	3	2,4							
NR4 65B-60/A		0,37	0,5		4,7			5,1	5	4,9	4,6	4,2	3,7	2,9						
NR4 65A-60/A		0,37	0,5		5,6			6	5,9	5,8	5,5	5,2	4,7	4,1	3,2					

3 ~		P ₂		Q m ³ /h																		
		kW	HP																			
						l/min	0	1	1,2	1,5	1,89	2,4	3	3,6	4,8	5,4	6	6,6	7,5	8,4	9,6	10,8
NR4 32/160B-60		0,37	0,5	H m	8,1	8,1	8,1	8,1	8	7,9	7,6	7,4	6,7	6,2	5,6	4,8						
NR4 32/160A-60		0,37	0,5		10,2	10,3	10,2	10,2	101	9,9	9,8	9,5	9	8,6	8,1	7,6						
NR4 32/200C-60		0,37	0,5		12	11,8	11,8	11,7	11,6	11,5	11,2	11	10,3	9,9	9,3	8,4	6,9	5,5				
NR4 32/200B-60		0,55	0,75		15,2	15,1	15,1	15,1	15	14,9	14,7	14,5	13,9	13,6	13,3	12,8	11,9	10,6	8,1			
NR4 32/200A-60/A		0,75	1		19,1	19,1	19,1	19,1	19	18,8	18,7	18,5	18	17,7	17,4	17	16,2	15,3	13,9	12,2		

3 ~		P ₂		Q m ³ /h																		
		kW	HP																			
						l/min	0	2,4	3	3,6	4,8	5,4	6	7,5	8,4	9,6	10,8	12	13,2	15		
NR4 40/160B-60		0,37	0,5	H m	7,8	7,7	7,6	7,5	7,3	7,2	7	6,5	6,1	5,4	4,5	3,6	2,5					
NR4 40/160A-60		0,37	0,5		9,4	9,4	9,3	9,3	9,1	8,9	8,7	8,3	7,9	7,3	6,6	5,7	4,7	3				
NR4 40/200B-60		0,55	0,75		13,6	13,2	13	12,8	12,4	12,2	11,9	11,2	10,5	9,3	7,8	6,2	4,3					
NR4 40/200A-60/A		0,75	1		15,3	14,9	14,8	14,6	14,2	14	13,8	13,1	12,6	11,7	10,4	8,9	7,2	4,1				

3 ~		P ₂		Q m ³ /h																				
		kW	HP																					
						l/min	0	5,4	6	7,5	8,4	9,6	10,8	12	13,2	15	16,8	18,9	21	24	27	30		
NR4 50/160C-60		0,37	0,5	H m	6,4	6,5	6,5	6,3	6,2	6	5,7	5,5	5,1	4,5	3,9	3								
NR4 50/160B-60		0,55	0,75		7,6	7,8	7,8	7,7	7,6	7,5	7,3	7	6,8	6,3	5,8	5,1	4,3*							
NR4 50/160A-60/B		0,75	1		9,2	9,4	9,4	9,3	9,1	9	8,7	8,5	8,2	7,7	7	6,2	5,3*	3,8*						
NR4 50/200B-60/B		1,1	1,5		13,3	13,1	13	12,7	12,4	12	11,6	11,2	10,7	9,9	8,9	7,8								
NR4 50/200A-60/B		1,1	1,5		14,9	14,8	14,7	14,4	14,1	13,8	13,4	13,1	12,7	12,0	11,1	10	9							
NR4 50/250C-60/B		1,5	2		18,5	18,5	18,4	18,1	17,9	17,6	17,2	16,9	16,5	15,8	15	13,4	11,3	7,2						
NR4 50/250B-60/B		2,2	3		23	23	22,9	22,7	22,6	22,4	22,1	21,8	21,4	20,9	20,3	19,4	18,4	16,3	13					
NR4 50/250A-60/A		3	4		25,4	25,4	25,3	25,2	25	24,8	24,6	24,3	24	23,5	23	22,2	21,4	19,9	17,5	14				

3 ~		P ₂		Q m ³ /h																		
		kW	HP																			
						l/min	0	10,8	12	13,2	15	16,8	18,9	21	24	27	30	33	37,8	42	48	
NR4 65/125F-60		0,37	0,5	H m	4	3,8	3,8	3,7	3,6	3,4	3,3	3,1	2,7	2,3	1,9	1,4						
NR4 65/125D-60		0,55	0,75		5	4,7	4,7	4,6	4,5	4,4	4,3	4	3,7	3,3	2,9	2,4	1,6					
NR4 65/125A-60/B		0,75	1		6,4	6,4	6,4	6,3	6,2	6,1	5,9	5,7	5,3	4,8	4,3	3,8	2,9	1,9				
NR4 65/160B-60/B		1,1	1,5		8,9	9,2	9,1	9,1	8,9	8,8	8,6	8,3	7,8	7,2	6,6	5,8	4,4*					
NR4 65/160A-60/B		1,1	1,5		10,5	10,8	10,8	10,8	10,7	10,6	10,4	10,2	9,8	9,3	8,8	8,2	7*	5,8*				
NR4 65/200C-60/B		1,1	1,5		11,1	10,9	10,8	10,6	10,4	10,1	9,6	9,1	8,3	7,2	5,8	4,3						
NR4 65/200B-60/B		1,5	2		12,6	12,6	12,4	12,3	12,1	11,8	11,5	11	10,3	9,4	8,4	7,1	4,7					
NR4 65/200A-60/B		2,2	3		16,6	16,8	16,7	16,6	16,4	16,2	16	15,7	15,2	14,6	13,8	13	11,6	9,9				
NR4 65/250C-60/B		2,2	3		18,9	19,2	19,1	19	18,8	18,5	18,1	17,7	16,9	16	15,1	14,1	12,3	10,4				
NR4 65/250B-60/A		3	4		22,7	23,1	23,1	22,95	22,9	22,7	22,3	22	21,5	20,8	19,9	19	17,5	16				
NR4 65/250A-60/A		4	5,5		23,7	24,2	24,2	24,2	24,1	23,9	23,6	23	22,7	22	21,2	20,4	18,9	17,4				

3 ~		P ₂		Q m ³ /h																		
		kW	HP																			
						l/min	0	333	417	500	583	667	833	1000	1167	1333	1500	1667	1840			
NR4 100C-60/B		1,1	1,5	H m	6,75	6,75	6,7	6,6	6,3	6	4,9	3,5										
NR4 100B-60/B		1,1	1,5		7,7	7,7	7,6	7,5	7,2	6,9	6	4,5										
NR4 100A-60/B		1,5	2		9,5	9,4	9,3	9,2	9	8,6	7,7	6,5	5									
NR4 125C-60/B		2,2	3		10,8			10,9	10,8	10,7	10,5	9,7	8,9	7,7	5,7							
NR4 125B-60/A		3	4		12,4			12,7	12,6	12,5	12,4	12	11,2	10,2	8,8	7						
NR4 125A-60/A		4	5,5		13,9			13,9	13,8	13,8	13,7	13,5	12,9	12	10,9	9,4	7,7					

P₂ Rated motor power output.
Potencia nominal del motor.

H Total head in m.
Altura total en m.

Tolerances according to UNI EN ISO 9906:2012.
Tolerancias según UNI EN ISO 9906:2012.

Rated currents - Intensidades nominales

2 Pole - Polos

P2		single-phase - monofásico 1~			IA/IN
kW	HP	220V IN A	127V IN A	110V IN A	
0,45	0,6	4,1	7,1	8,2	2,5
0,75	1	6,9	12	13,8	2,9

	P2		three-phase - trifásico 3~			IA/IN
	kW	HP	220/380V IN A	380/660V IN A	220/440V IN A	
	0,45	0,6	2,6/1,5	-	2,7/1,6	3,5
NR 50C-60/A	0,75	1	4,5/2,6	-	4,7/2,7	5,6
	0,75	1	4,8/2,8	-	5,1/2,9	6
	1,1	1,5	5,7/3,3	-	6,0/3,5	5,4
	1,5	2	9/5,2	-	9,4/5,5	6,1
	2,2	3	11,1/6,4	-	11,6/6,7	8,4
	3	4	13,4/7,7	-	14,0/8,1	8,4
	4	5,5	-	11,2/6,5	-	9,2
	5,5	7,5	-	13,7/7,9	-	8,7
	7,5	10	-	17/9,8	-	9,2
	9,2	12,5	-	22/12,7	-	8,3
	11	15	-	25,8/14,9	-	8,9
	15	18,5	-	33,2/19,2	-	9,4
	18,5	25	-	40,8/23,6	-	9,3

4 Pole - Polos

P2		single-phase - monofásico 1~			IA/IN
kW	HP	220V IN A	127V IN A	110V IN A	
0,25	0,34	2,5	4,3	5	3,9

	P2		three-phase - trifásico 3~			IA/IN
	kW	HP	220/380V IN A	380/660V IN A	220/440V IN A	
	0,25	0,34	1,7/1	-	1,8/1,1	3,5
	0,37	0,5	2/1,1	-	2,1/1,2	4,1
NR4 65A,B-60/A	0,37	0,5	2,4/1,4	-	1,5/2,5	3,6
	0,55	0,75	3,1/1,8	-	3,3/1,7	4,5
	0,75	1	3,8/2,2	-	4,0/2,3	7,5
	1,1	1,5	5,8/3,3	-	6,0/3,5	7
	1,5	2	7/4	-	7,3/4,2	8,7
	2,2	3	9,8/5,7	-	10,4/6,0	9,1
	3	4	13,5/7,8	-	14,2/8,2	5,7
	4	5,5	-	10,2/5,9	-	7

P2 Rated motor power output.
Potencia nominal del motor.

IA/IN D.O.L. starting current / Rated current
Intensidad de arranque / Intensidad nominal

Characteristic curves - Curvas Características

n ≈ 3450 rpm

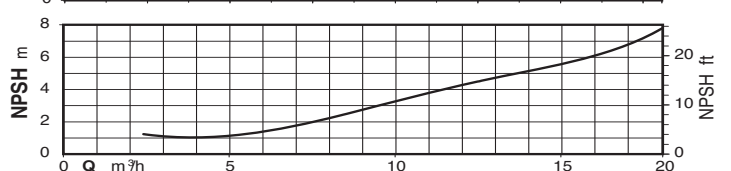
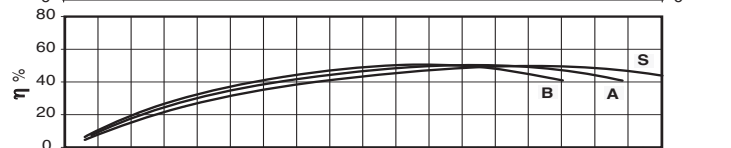
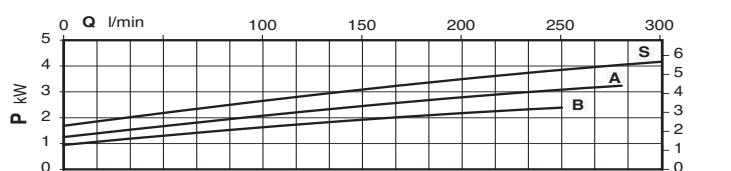
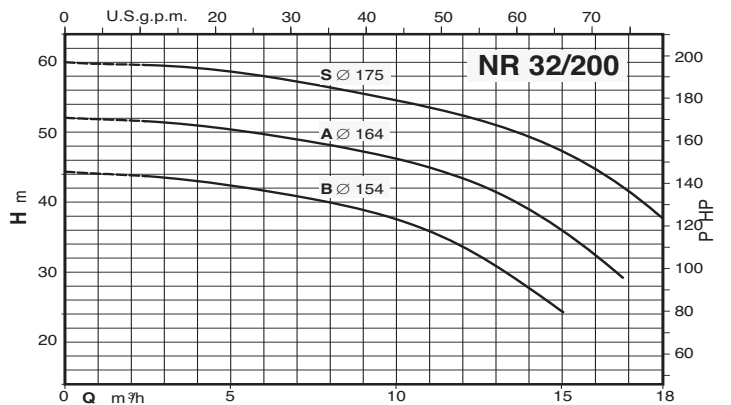
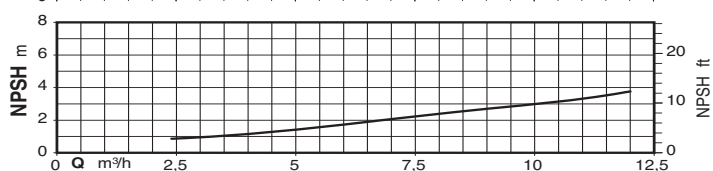
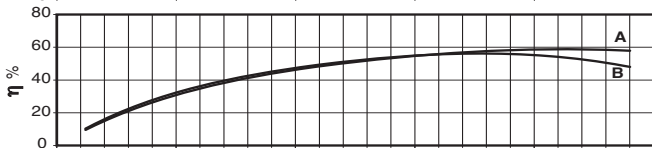
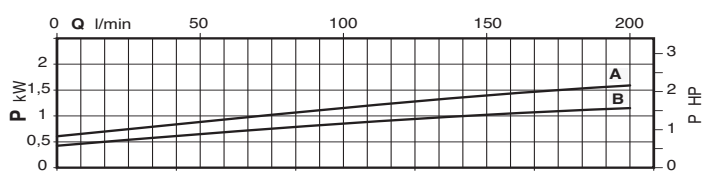
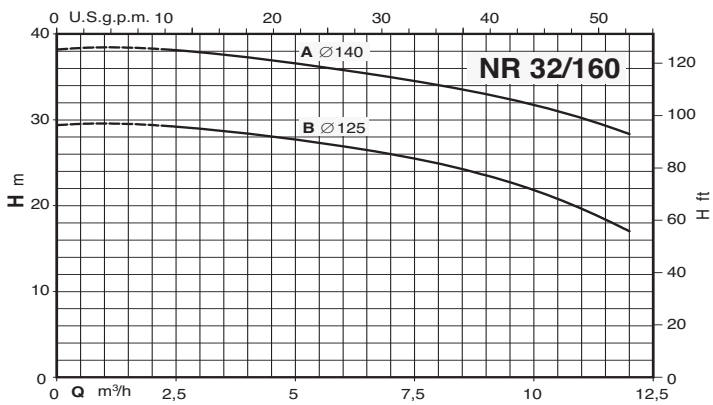
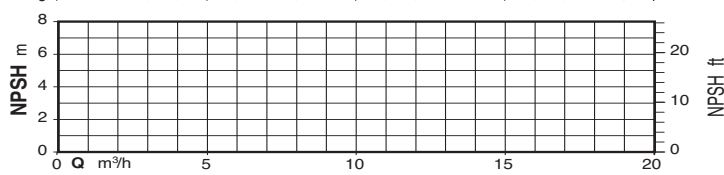
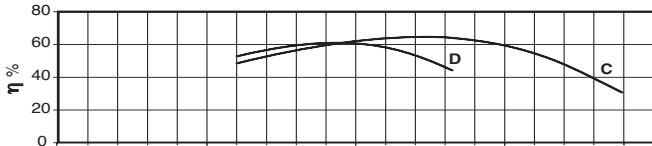
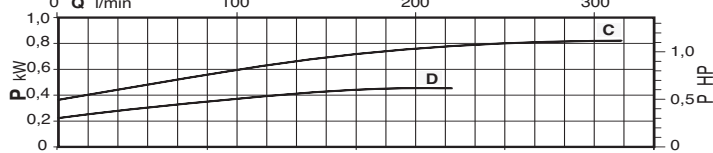
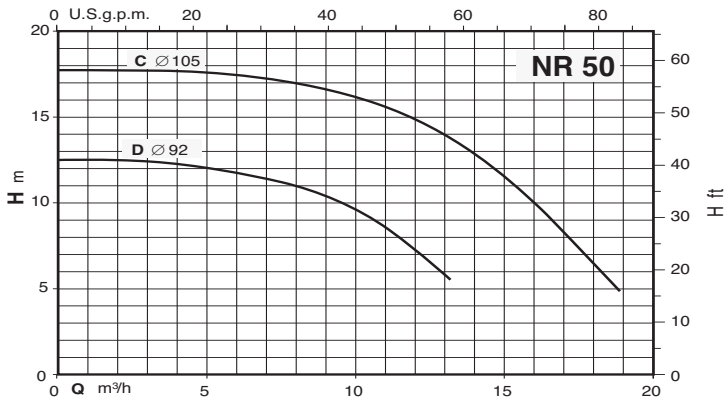

Characteristic curves - Curvas Características

n ≈ 3450 rpm

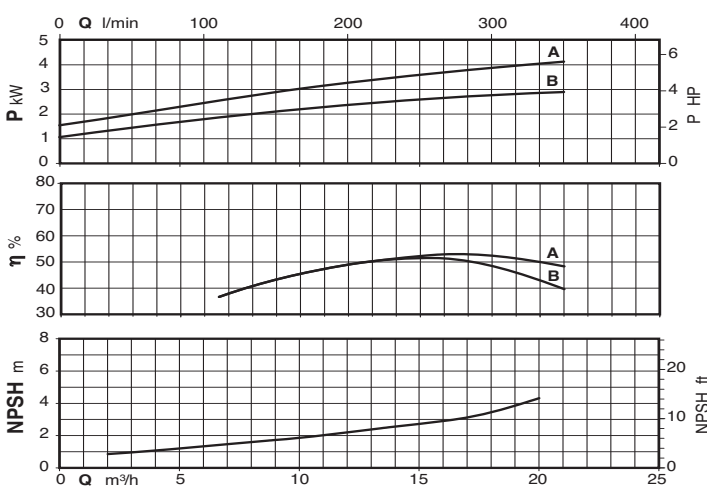
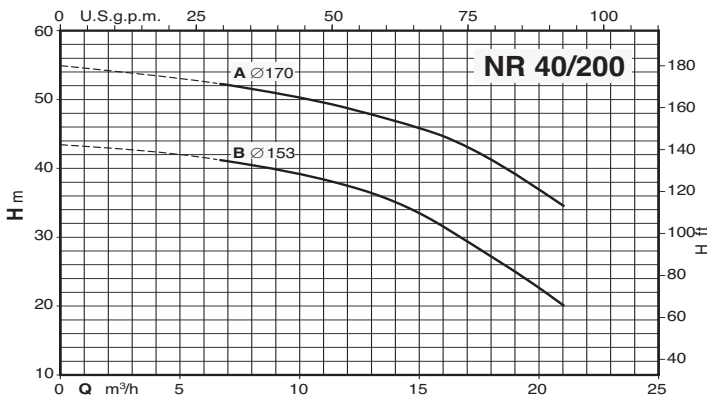
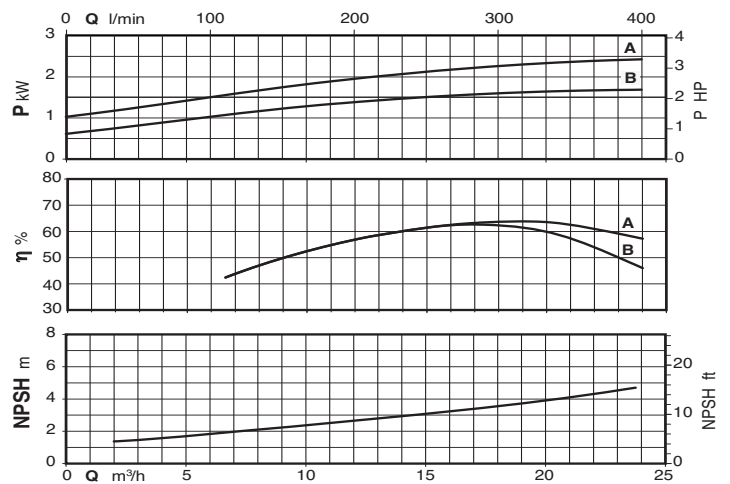
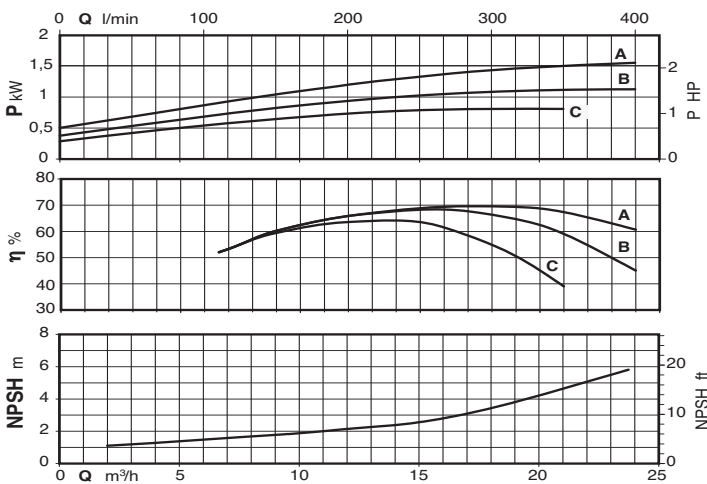
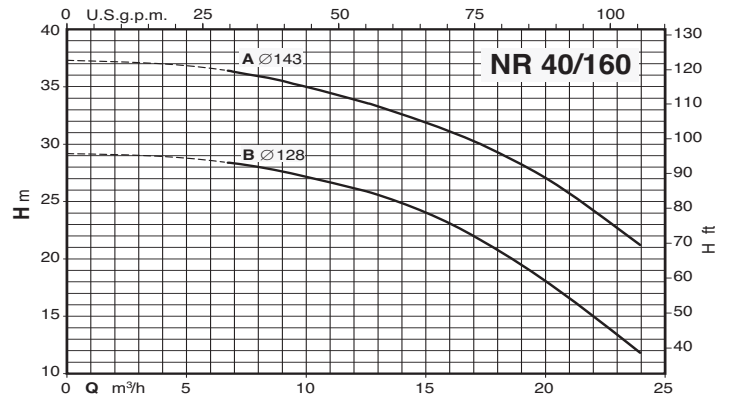
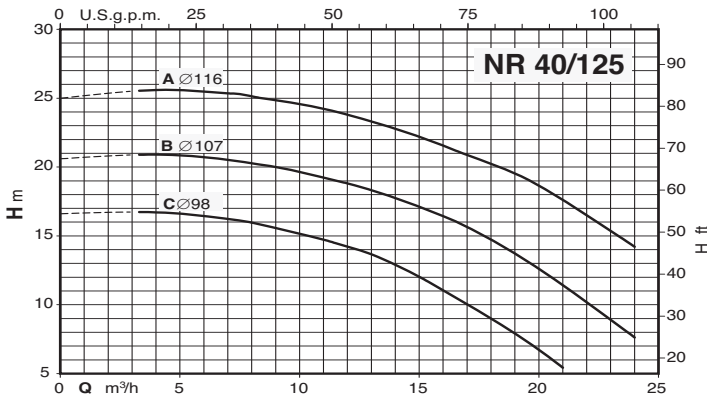

Characteristic curves - Curvas Características

n ≈ 3450 rpm

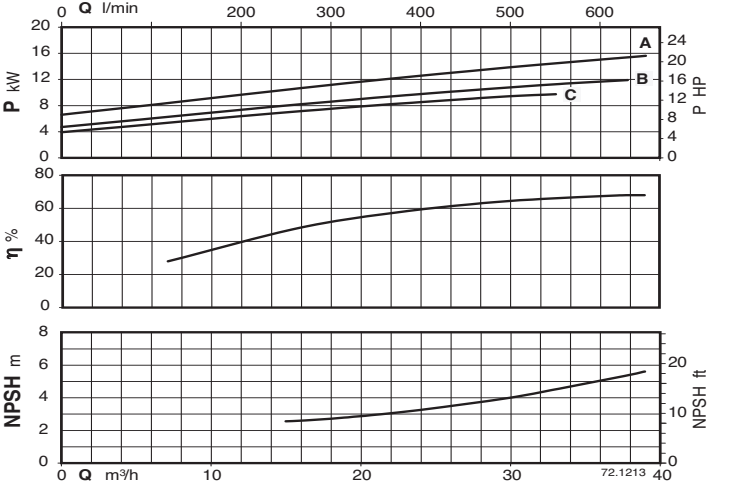
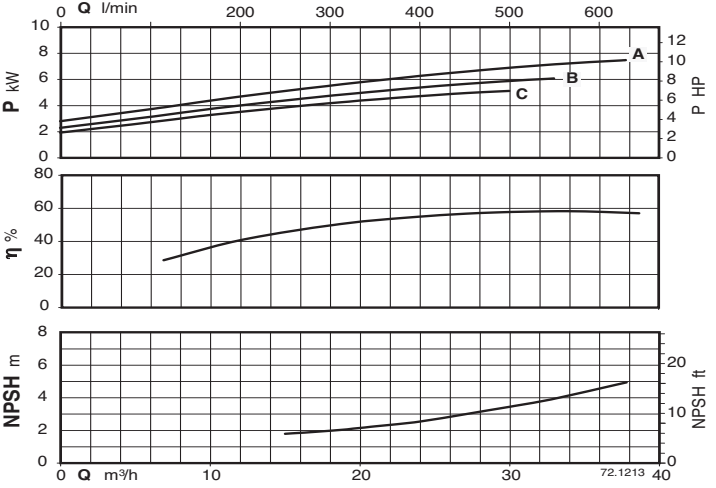
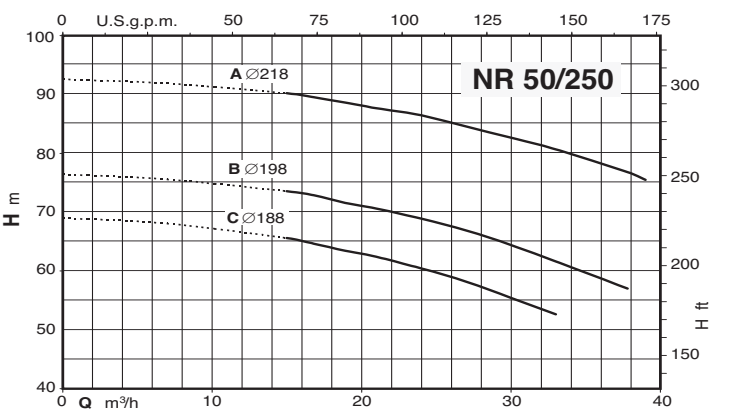
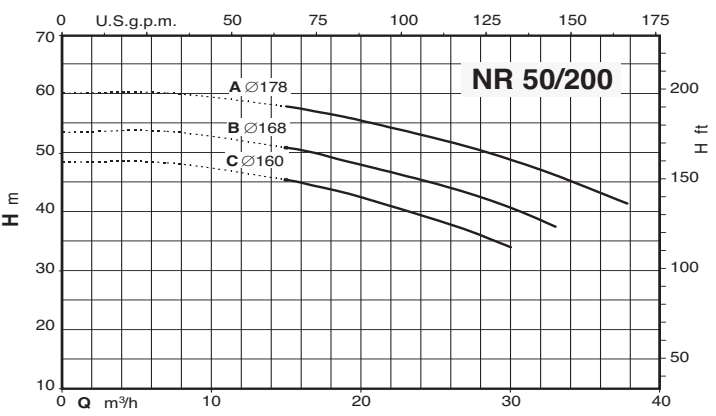
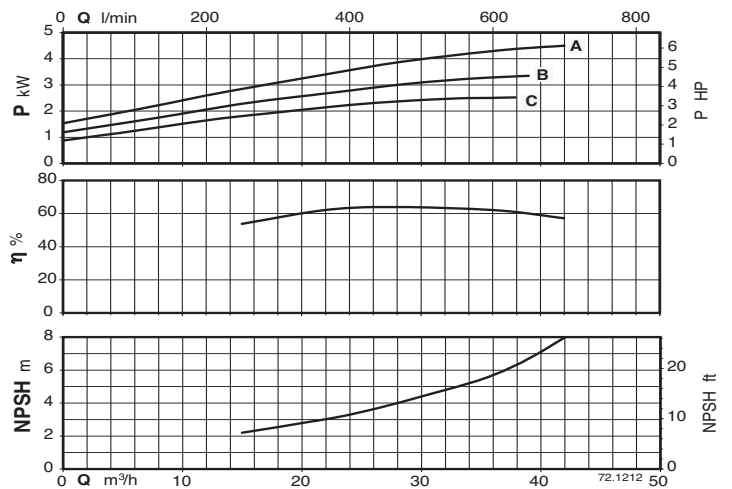
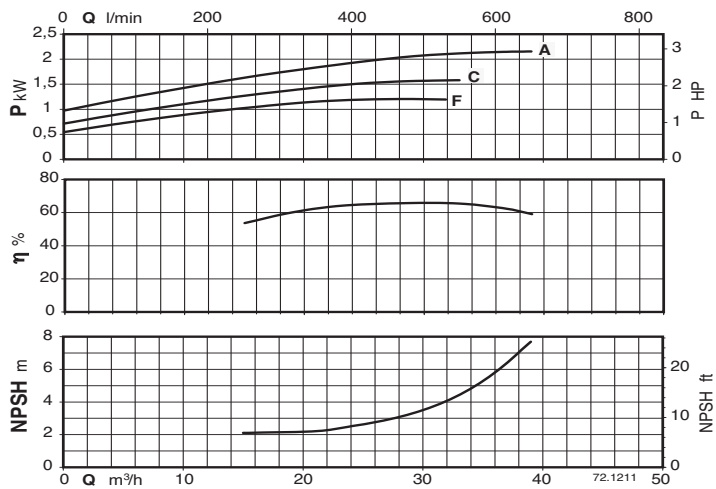
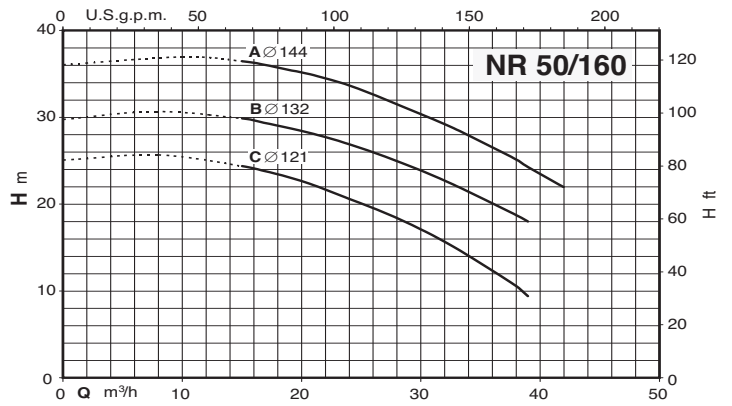
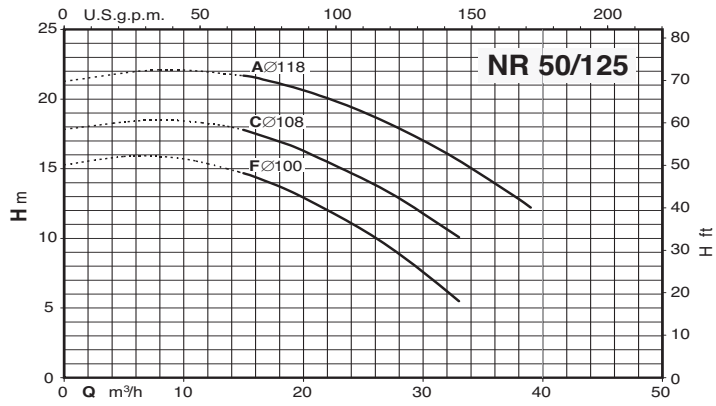

Characteristic curves - Curvas Características

n ≈ 3450 rpm

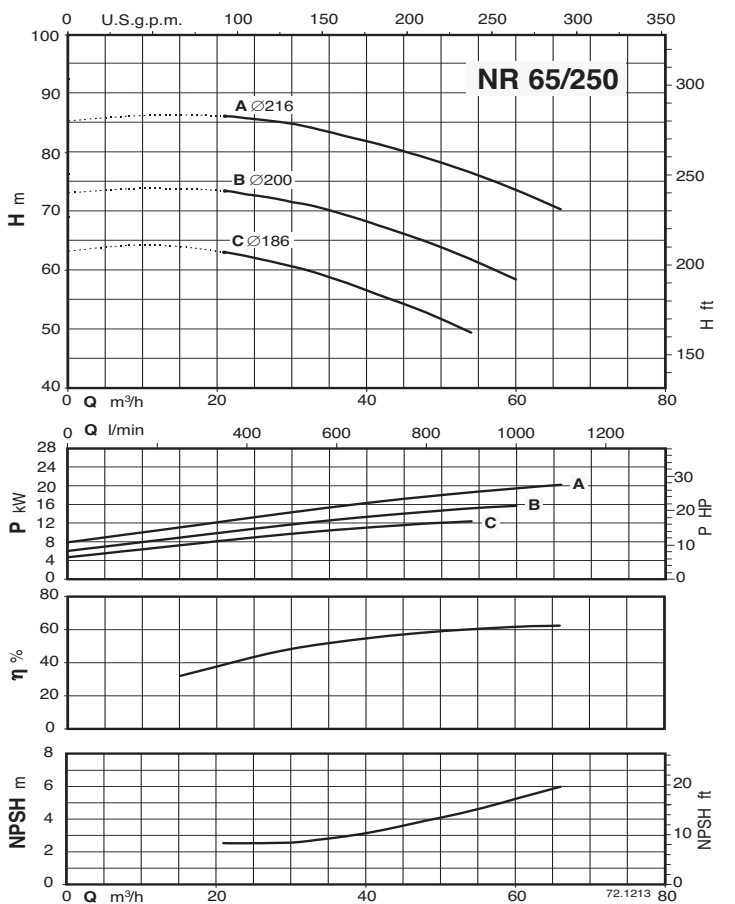
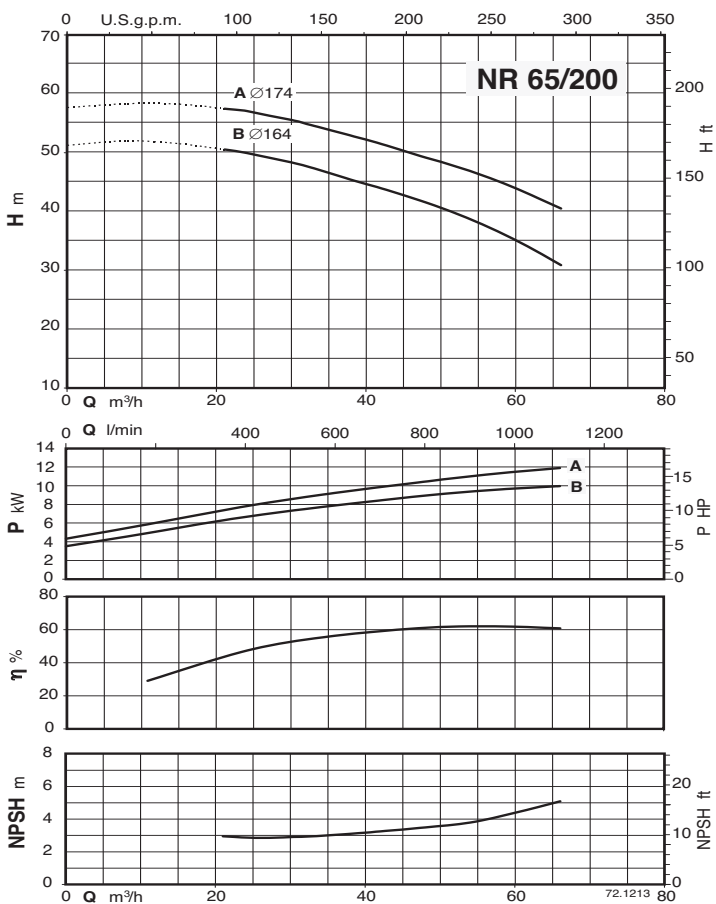
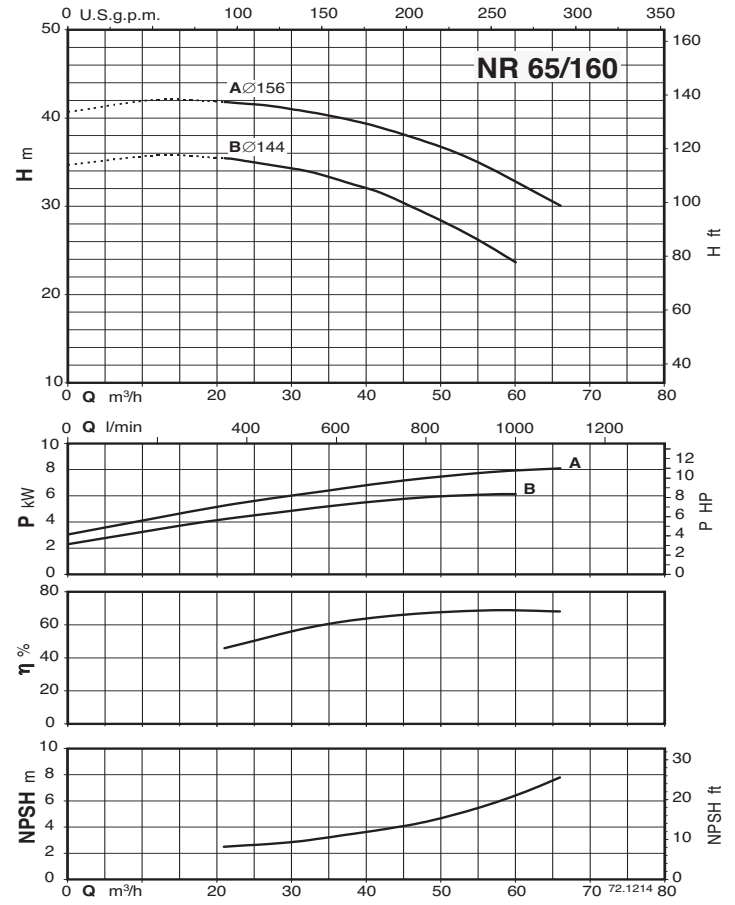
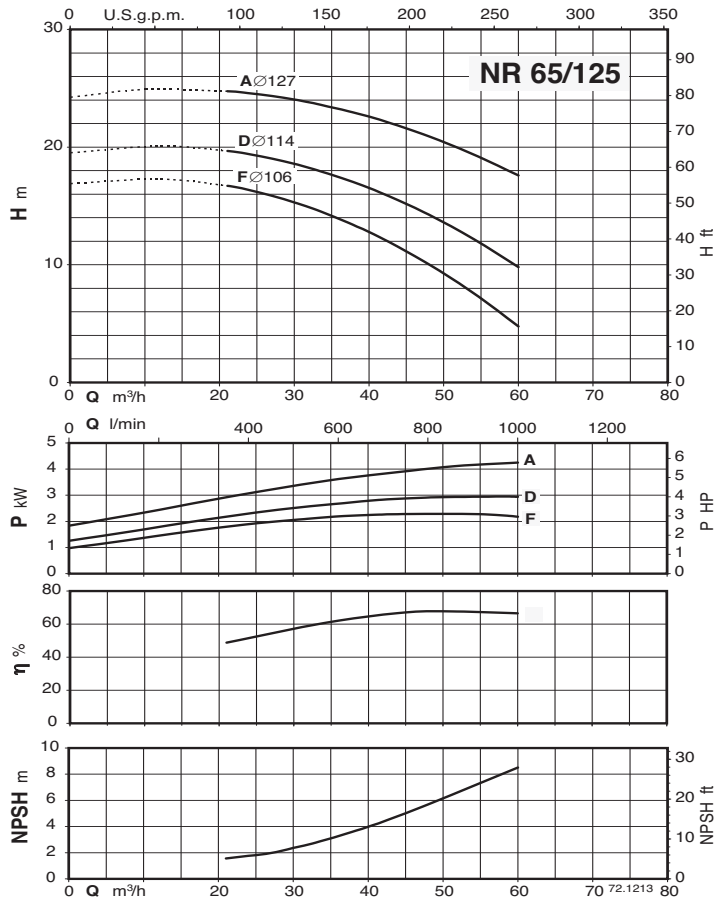

NR4 60 Hz



Characteristic curves - Curvas Características

n ≈ 1750 rpm

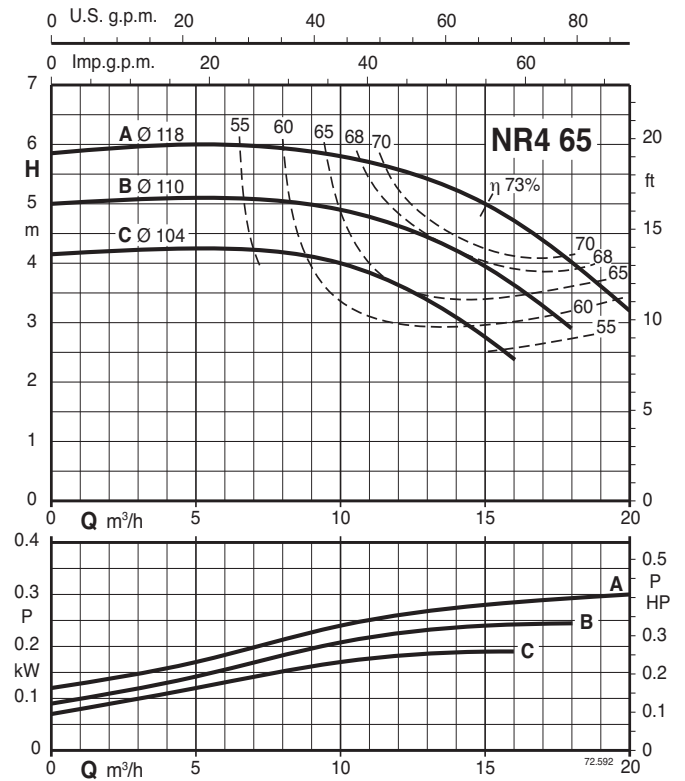
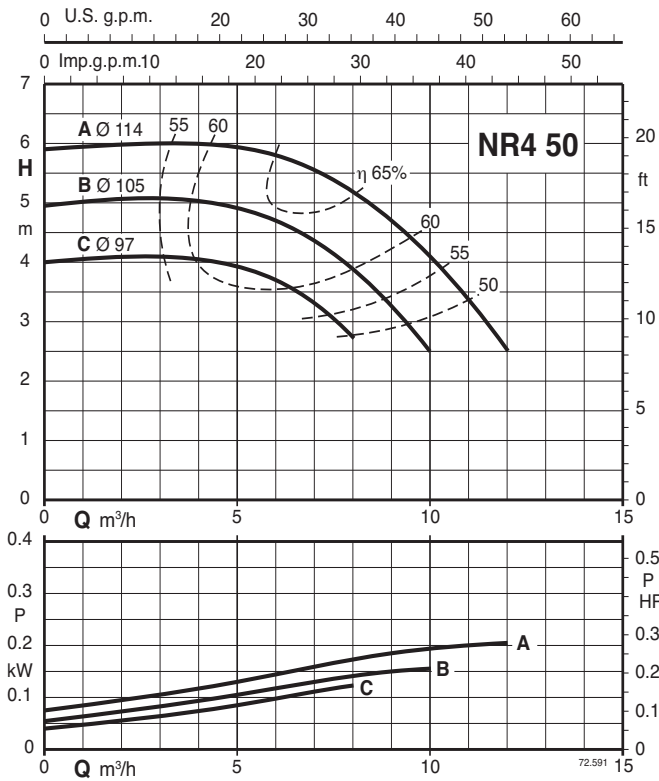

Characteristic curves - Curvas Características

n ≈ 1750 rpm

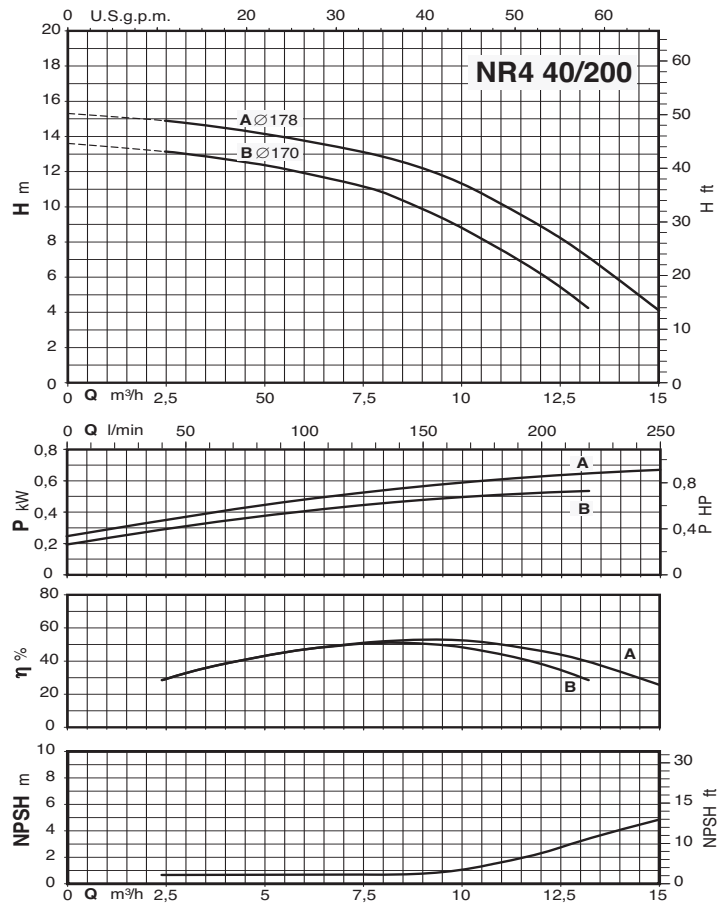
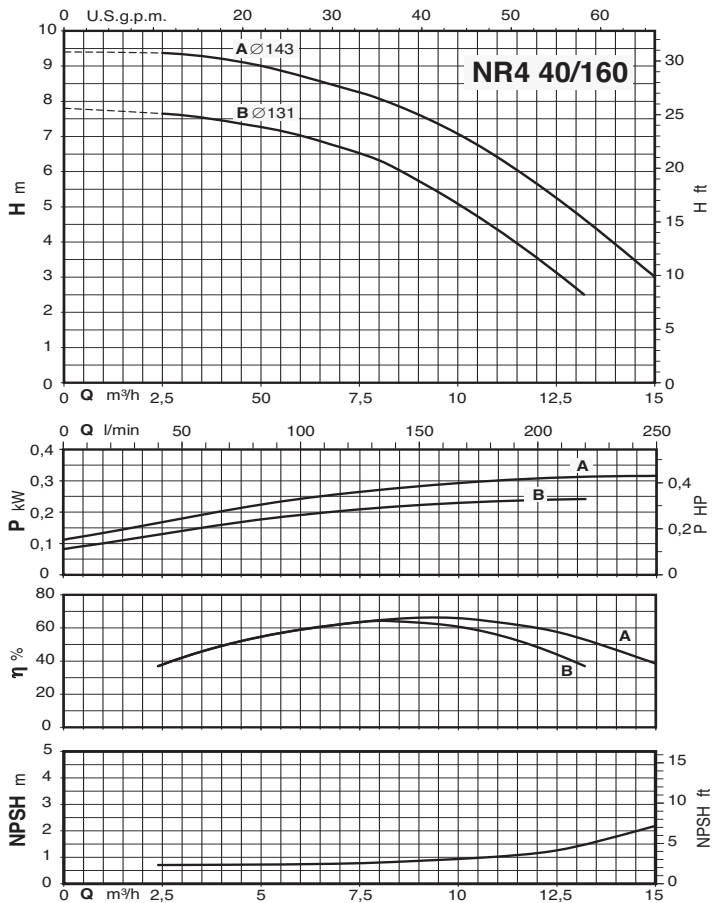
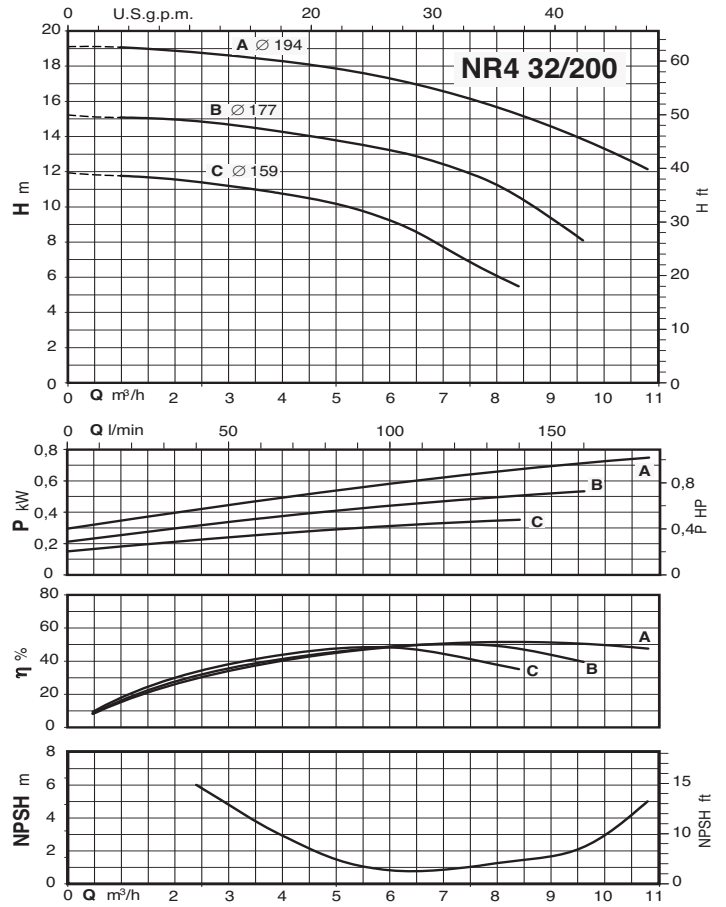
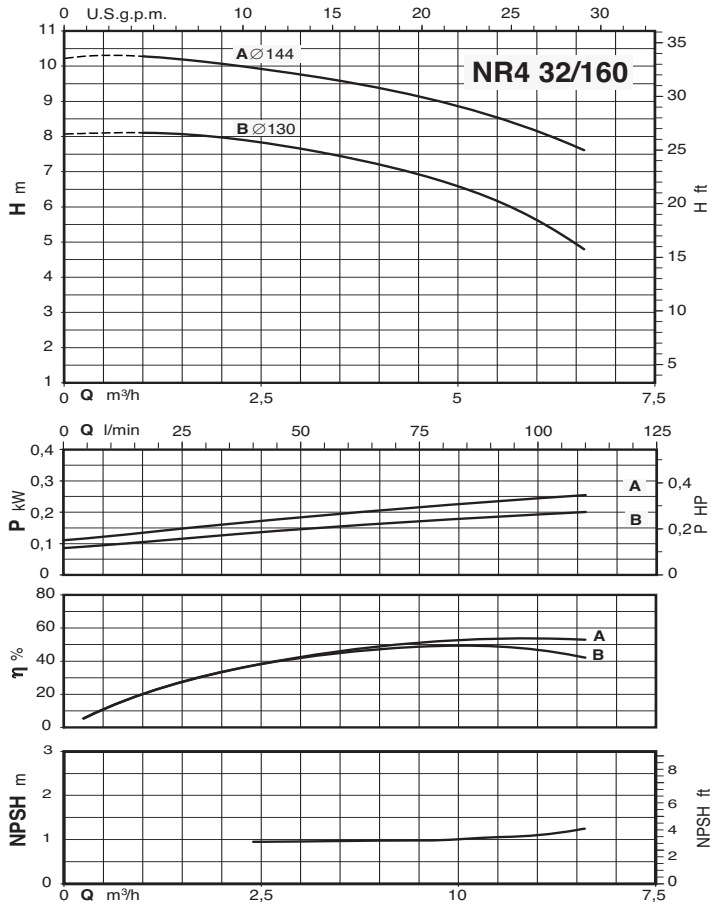

Characteristic curves - Curvas Características

n ≈ 1750 rpm

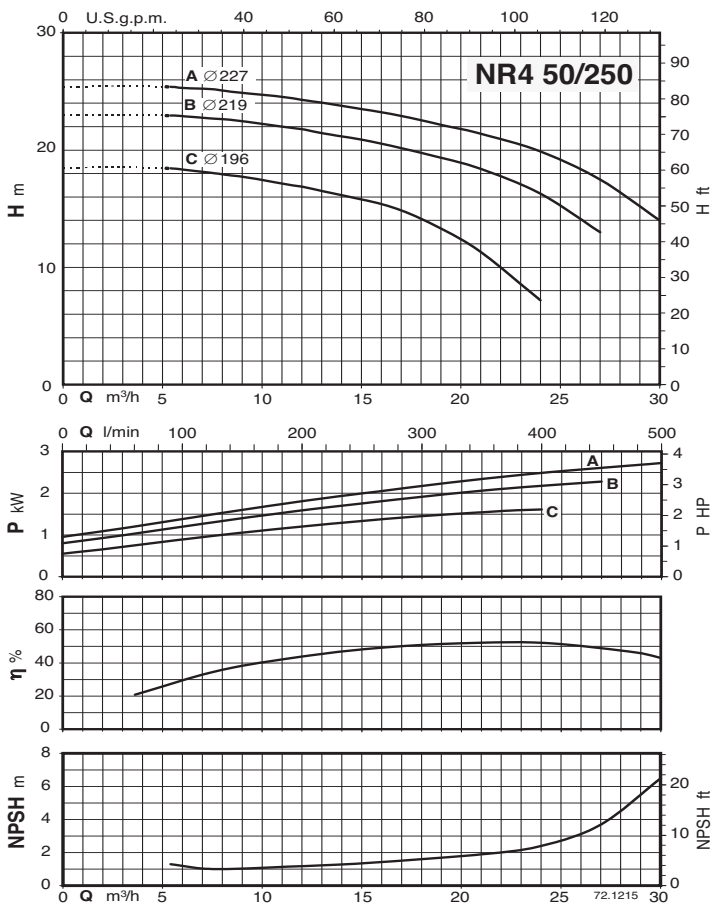
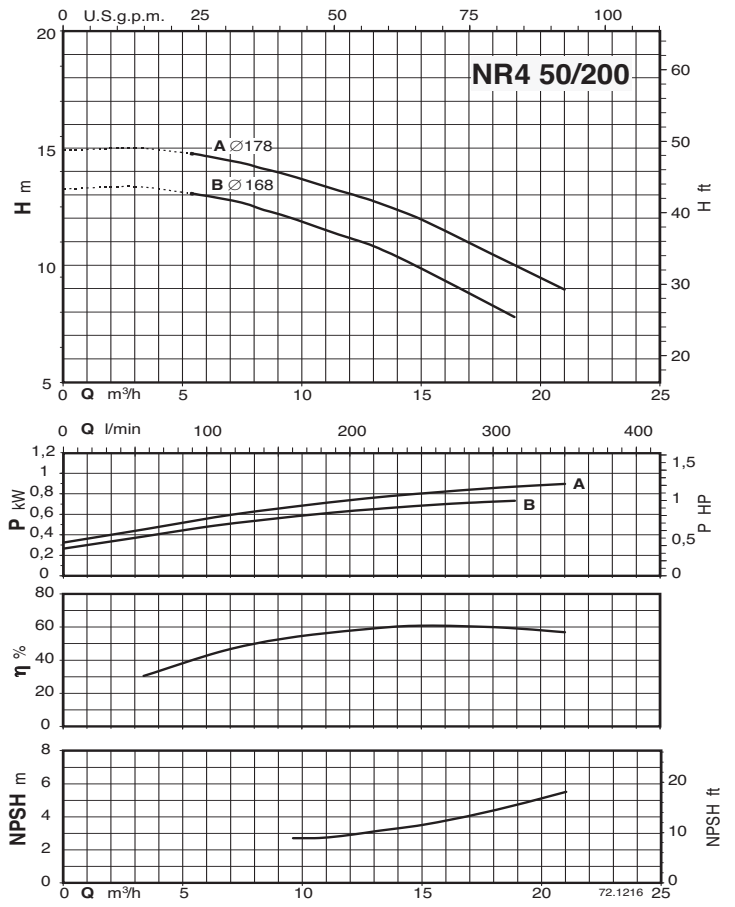
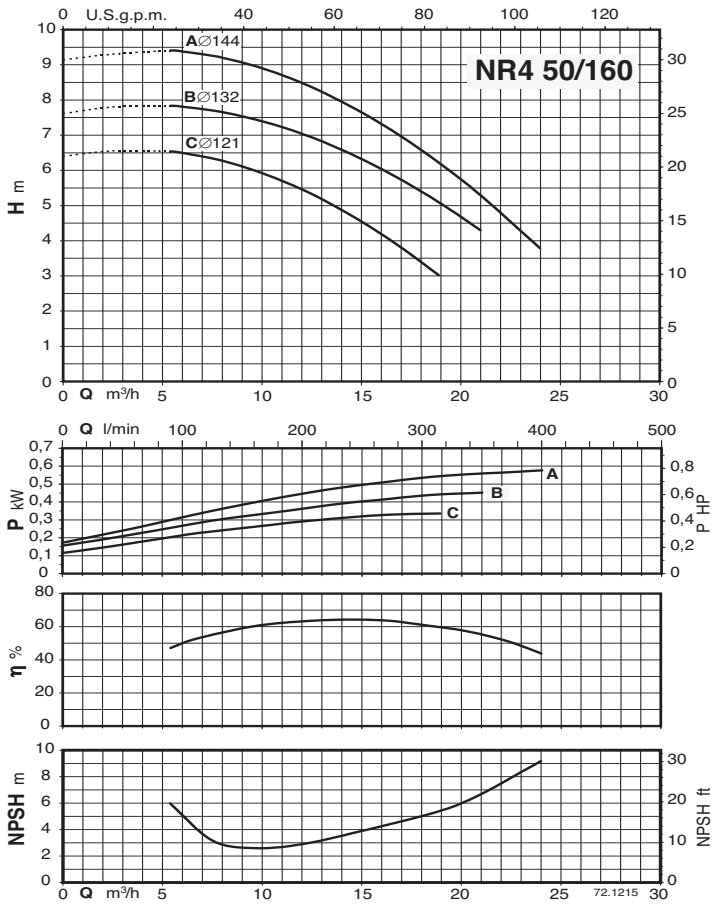

Characteristic curves - Curvas Características

n ≈ 1750 rpm

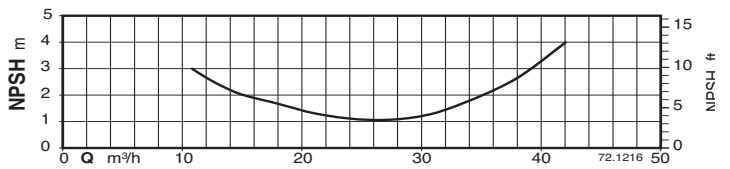
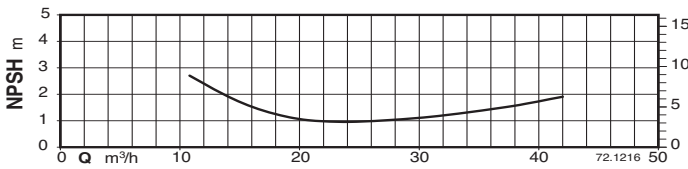
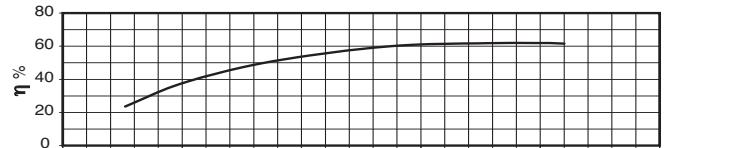
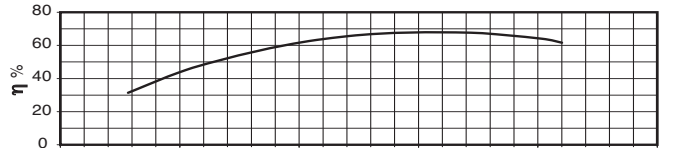
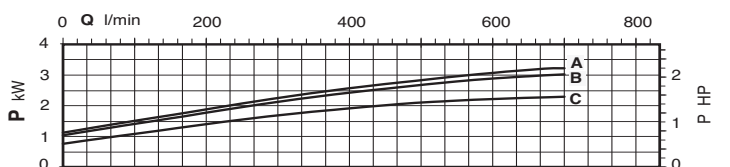
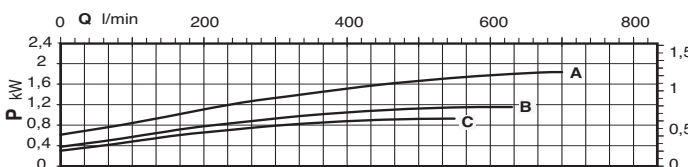
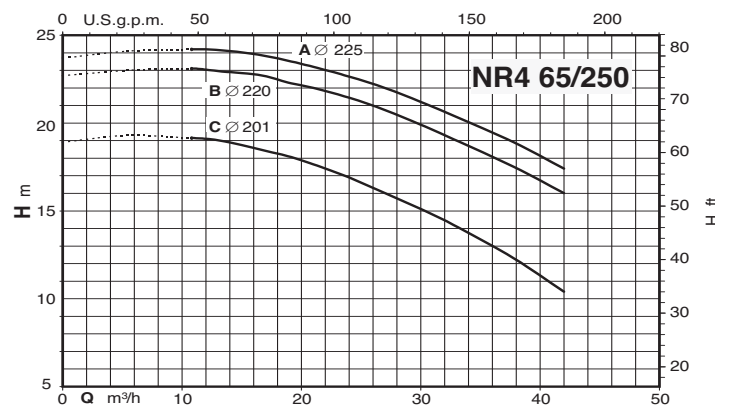
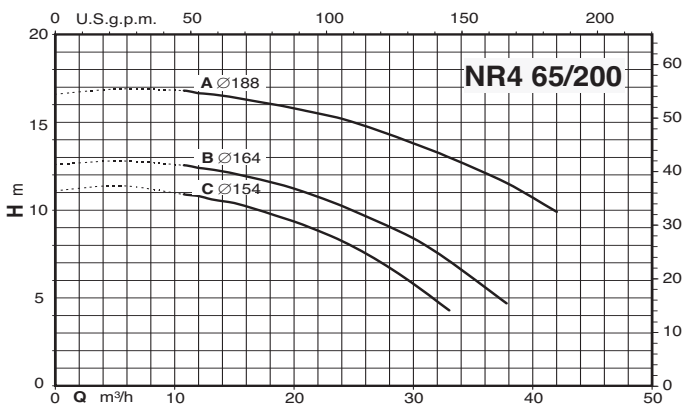
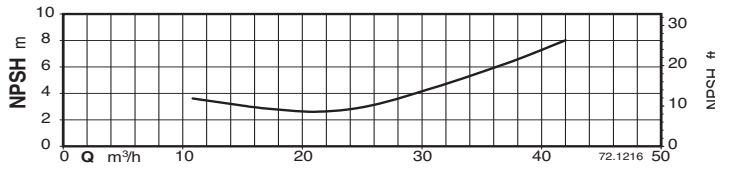
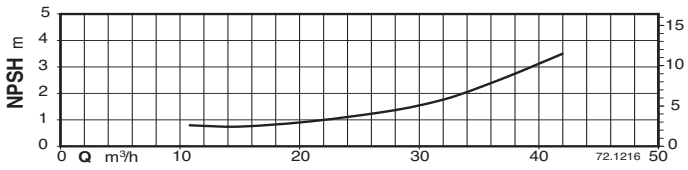
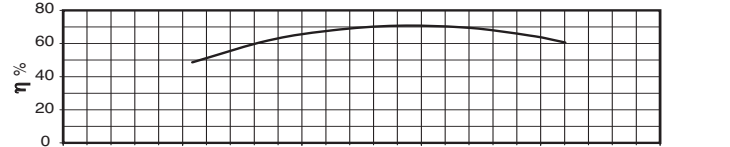
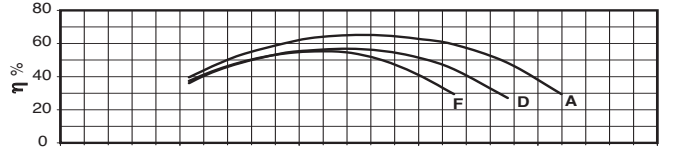
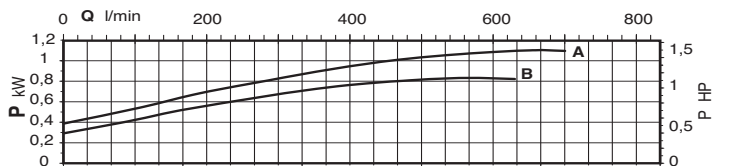
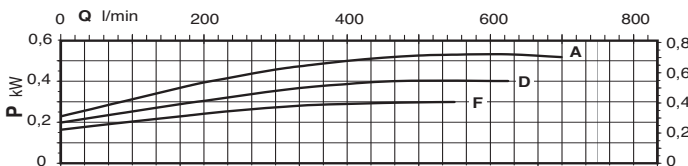
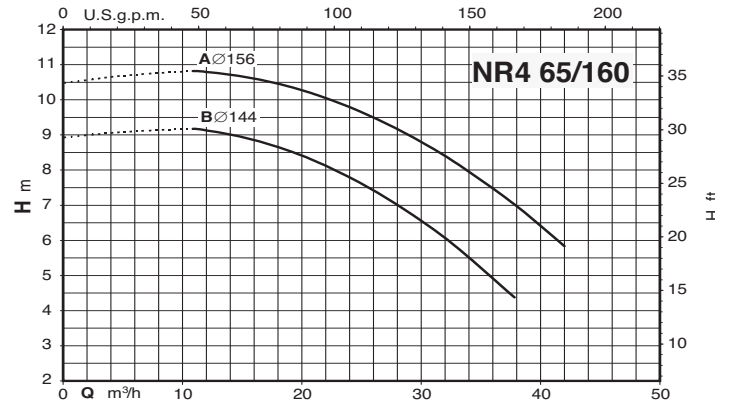
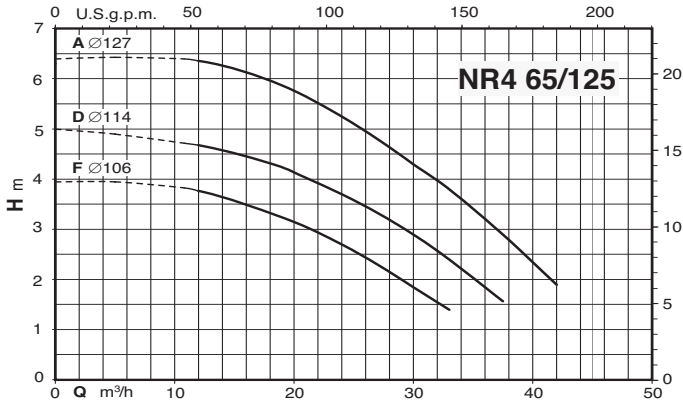

NR4 60 Hz



Characteristic curves - Curvas Características

n ≈ 1750 rpm

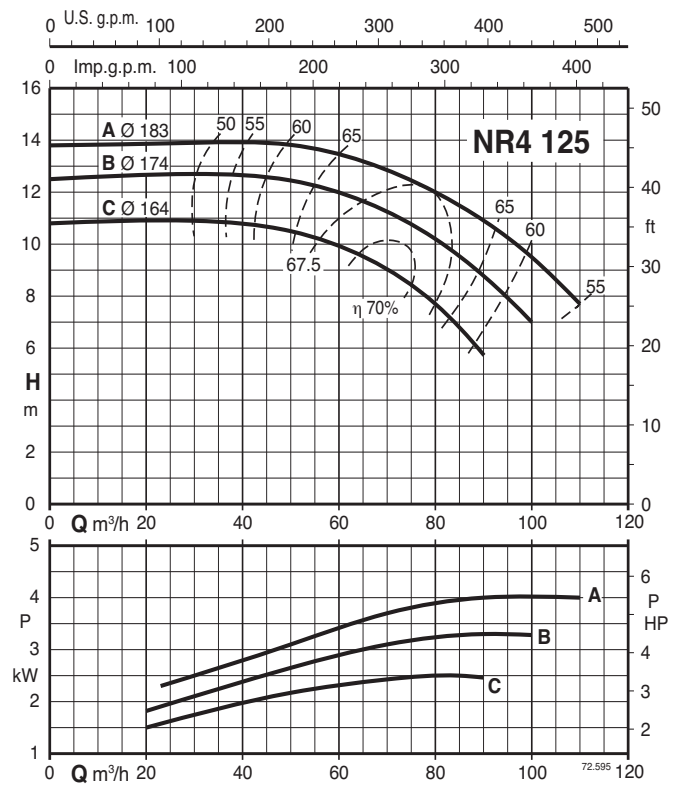
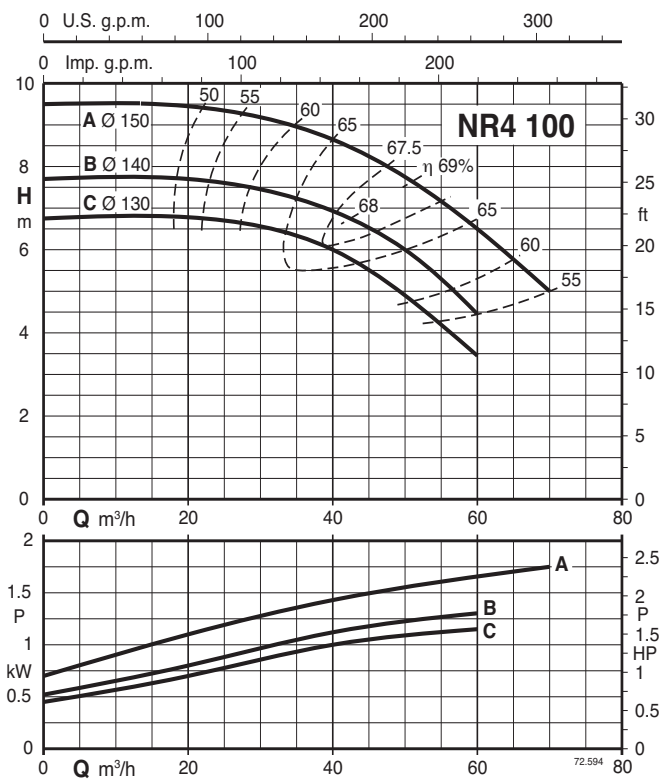

Dimensions and weights - Dimensiones y pesos

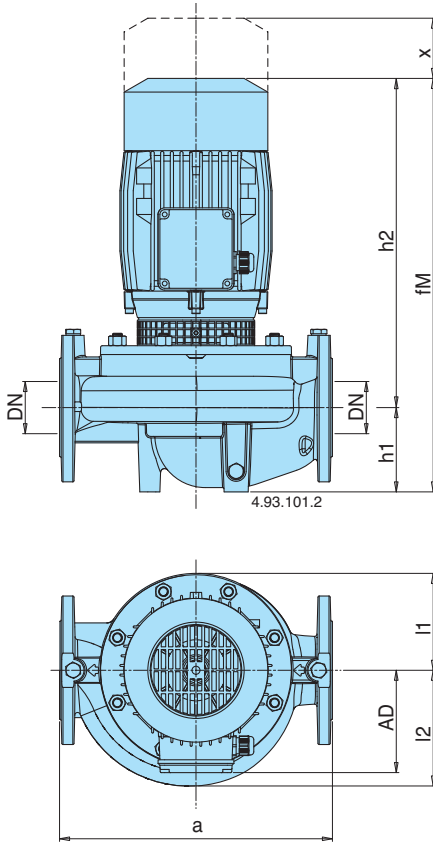

TYPE TIPO	mm										kg
	DN	a	fM	h1	h2	Øb	AD	l1	l2	x	
NR 50D-60/A, C-60/B	50	320	360	90	270	98	111	93	100	70	21,7-23,8
NR 32/160A-60/A, B-60/A	32	340	421	80	341	-	128	102	102	60	28,6-27
NR 32/200B-60	32	440	469	85	384	-	128	126	126	60	36,3
NR 32/200A-60/A, S-60/A	32	440	495	85	410	-	138	126	126	60	44-47
NR 40/125A-60/A, B-60/A, C-60	40	320	420	81	339	-	128	93	98	70	29,5-27,5-26,5
NR 40/160B-60/A	40	320	430	81	349	-	128	119	119	75	35,0
NR 40/160A-60/A	40	320	470	81	389	-	128	119	119	75	40,0
NR 40/200A-60/A, B-60	40	440	496	81	430	-	138	140	140	75	56,6-53,4
NR 50/125C-60/A, F-60/A	50	340	437	90	347	-	128	96	115	75	31,5-29,5
NR 50/125A-60/B	50	340	477	90	387	-	128	96	115	75	36,1
NR 50/160C-60/B	50	340	480	90	390	-	128	120	128	75	41,6
NR 50/160A-60/B, B-60/A	50	340	506	90	416	-	138	120	128	75	51,8-48,5
NR 50/200C-60/B	50	440	516	100	416	-	138	140	140	80	59,7
NR 50/200A-60/A, B-60/A	50	440	544	100	444	-	160	140	140	80	77,2-69,7
NR 50/250C-60/B	50	440	657	100	557	-	185	175	175	85	114
NR 50/250B-60/B	50	440	707	100	557	-	185	175	175	85	121
NR 50/250A-60/B	50	440	732	100	632	-	185	175	175	85	149,5
NR 65/125F-60/B	65	340	494	105	389	-	128	121	145	95	46
NR 65/125A-60/B, D-60/A	65	340	520	105	415	-	138	121	145	95	56,1-56,1-54,6
NR 65/160A-60/A, B-60/A	65	340	552	105	447	-	160	121	142	95	74-67,5
NR 65/200B-60/B	65	475	666	105	561	-	185	140	153	90	108
NR 65/200A-60/B	65	475	716	105	611	-	185	140	153	90	114
NR 65/250C-60/B	65	475	722	105	567	-	185	175	175	90	134
NR 65/250B-60/B	65	475	747	105	642	-	185	175	175	90	155
NR 65/250A-60/C	65	475	793	105	688	-	206	175	175	90	-

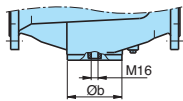

Flanges
Bridas PN 10, EN 1092-2

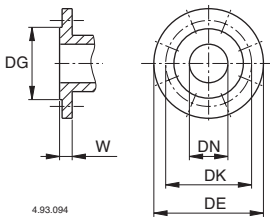

DN	mm					W
	DG	DK	DE	Holes N°	Ø	
32	76	100	140	4	19	18
40	84	110	150	4	19	18
50	99	125	165	4	19	20
65	118	145	185	4	19	20
80	132	160	200	8	19	22
100	156	180	220	8	19	24
125	184	210	250	8	19	24

TYPE TIPO	mm										kg
	DN	a	fM	h1	h2	Øb	AD	l1	l2	x	
NR4 50A-60/A, B-60/A, C-60/A	50	320	360	90	270	98	111	93	100	70	22-22-22
NR4 65A-60/A, B-60/A, C-60/A	65	360	370	100	270	118	111	102	114	70	28-28-28
NR4 100A-60/B, B-60/B, C-60/B	100	500	549	150	399	162	138	153	173	105	67-59-59
NR4 125C-60/B	125	600	589	170	419	194	138	172	195	120	91,5
NR4 125A-60/A, B-60/A	125	600	608	160	438	194	160	172	195	120	110-108
NR4 32/160A-60, B-60	32	340	421	80	341	-	128	102	102	60	23-22,9
NR4 32/200B-60, C-60	32	440	429	85	344	-	128	126	126	60	30,8-29,2
NR4 32/200A-60/A	32	440	469	85	344	-	128	126	126	60	
NR4 40/160A-60, B-60	40	320	430	81	349	-	128	119	119	75	31,5 - 31
NR4 40/200B-60	40	440	430	81	349	-	128	140	140	75	39,5
NR4 40/200A-60/A	50	440	470	81	349	-	128	140	140	75	43
NR4 50/160B-60, C-60	50	340	440	90	350	-	128	120	128	75	35,5-33,5
NR4 50/160A-60/B	50	340	480	90	350	-	128	120	128	75	37,5
NR4 50/200A-60/B, B-60/B	50	440	516	100	416	-	138	140	140	80	56
NR4 50/250C-60/B	50	440	516	100	416	-	138	175	175	85	77,5
NR4 50/250A-60/A, B-60/B	50	440	545	100	445	-	160	175	175	85	93,5-80
NR4 65/125D-60, F-60	65	340	454	105	349	-	128	121	145	95	39-37
NR4 65/125A-60/B	65	340	494	105	349	-	128	121	145	95	41,5
NR4 65/160A-60/B, B-60/B	65	340	504	105	399	-	138	121	142	95	42,7-42,5
NR4 65/200C-60/B	65	475	536	105	431	-	138	140	153	90	52
NR4 65/200B-60/B	65	475	536	105	431	-	138	140	153	90	60
NR4 65/200A-60/B	65	475	552	105	447	-	160	140	153	90	64,5
NR4 65/250C-60/B	65	475	555	105	450	-	160	175	175	90	75,5
NR4 65/250A-60/A, B-60/A	65	475	555	105	450		160	175	175	90	98-85

Installation - Instalación

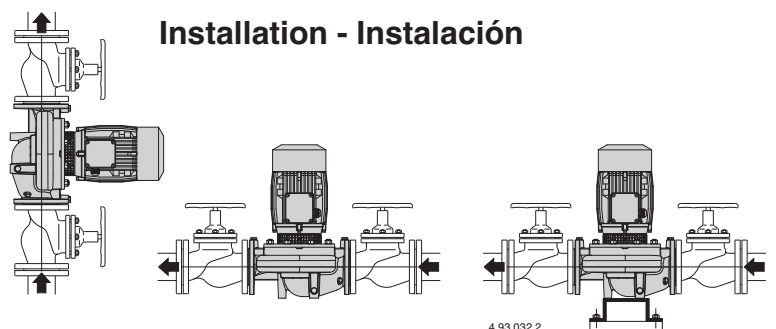

NR EI, NR4 EI 60 Hz



Dimensions and weights - Dimensiones y pesos

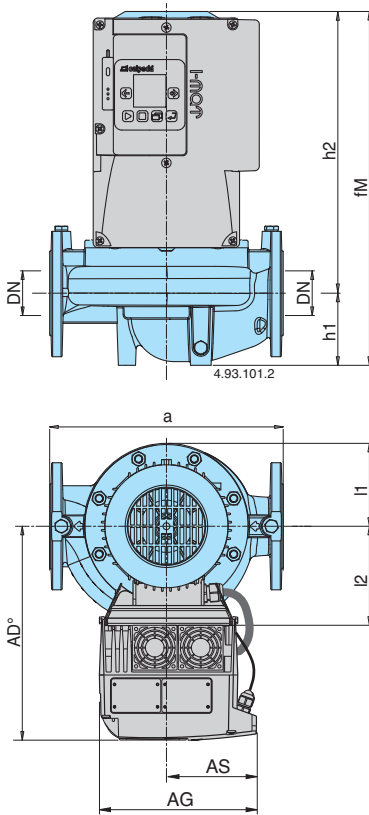

Flanges
Bridas PN 10, EN 1092-2

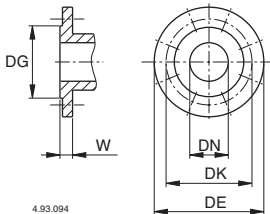

DN	mm					W
	DG	DK	DE	Holes N°	Ø	
32	76	100	140	4	19	18
40	84	110	150	4	19	18
50	99	125	165	4	19	20
65	118	145	185	4	19	20
80	132	160	200	8	19	22
100	156	180	220	8	19	24
125	184	210	250	8	19	24

TYPE TIPO	mm											kg
	DN	a	fM	h1	h2	AD°	AG	AS	l1	l2	x	
NR EI 50D-60/A, C-60/B	50	320	399	90	270	270	190	105	93	100	70	28-30,2
NR EI 32/160A-60/A, B-60/A	32	340	421	80	341	286	190	105	102	102	60	35-33,3
NR EI 32/200B-60	32	440	469	85	384	286	210	118	126	126	60	43,8
NR EI 32/200A-60/A, S-60/A	32	440	495	85	410	294	210	118	126	126	60	51,5-54,5
NR EI 40/125A-60/A, B-60/A, C-60	40	320	420	81	339	286	190	105	93	98	70	35,9-33,9-32,9
NR EI 40/160B-60/A	40	320	430	81	349	286	190	105	119	119	75	41,4
NR EI 40/160A-60/A	40	320	470	81	389	286	210	118	119	119	75	47,5
NR EI 40/200A-60/A, B-60	40	440	496	81	430	294	210	118	140	140	75	64,1-61
NR EI 50/125C-60/A, F-60/A	50	340	437	90	347	286	190	105	96	115	75	37,9-35,9
NR EI 50/125A-60/B	50	340	477	90	387	286	210	118	96	115	75	43,6
NR EI 50/160C-60/B	50	340	480	90	390	286	210	118	120	128	75	49,1
NR EI 50/160A-60/B, B-60/A	50	340	506	90	416	294	210	118	120	128	75	59,3-56
NR EI 50/200C-60/B	50	440	516	100	416	294	210	118	140	140	80	67,2
NR EI 50/200A-60/A, B-60/A	50	440	544	100	444	368	281	153	140	140	80	92-84,5
NR EI 50/250C-60/B	50	440	657	100	557	393	281	153	175	175	85	128,8
NR EI 50/250B-60/B	50	440	707	100	557	393	281	153	175	175	85	135,8
NR EI 50/250A-60/B	50	440	732	100	632	471	350	190	175	175	85	184,5
NR EI 65/125F-60/B	65	340	494	105	389	286	210	118	121	145	95	53,5
NR EI 65/125A-60/B, D-60/A	65	340	520	105	415	294	210	118	121	145	95	63,6-63,6-62,1
NR EI 65/160A-60/A, B-60/A	65	340	552	105	447	368	281	153	121	142	95	88,8-82,3
NR EI 65/200B-60/B	65	475	666	105	561	368	281	153	140	153	90	122,8
NR EI 65/250A-60/B	65	475	716	105	611	393	281	153	140	153	90	128,8
NR EI 65/250C-60/B	65	475	722	105	567	393	281	153	175	175	90	148,8
NR EI 65/250B-60/B	65	475	747	105	642	471	350	190	175	175	90	190
NR EI 65/250A-60/C	65	475	793	105	688	491	350	190	175	175	90	-

TYPE TIPO	mm											kg
	DN	a	fM	h1	h2	AD°	AG	AS	l1	l2	x	
NR4 EI 50A-60/A, B-60/A, C-60/A	50	320	399	90	270	270	190	105	93	100	70	28,4-28,4-28,4
NR4 EI 65A-60/A, B-60/A, C-60/A	65	360	409	100	270	270	190	105	102	114	70	34,4-34,4-34,4
NR4 EI 100B-60/B, C-60/B	100	500	549	150	399	294	190	105	153	173	105	65,4-65,4
NR4 EI 100A-60/B	100	500	549	150	399	294	190	105	153	173	105	73,4
NR4 EI 125A-60/A, B-60/A, C-60/B	125	600	608	160	438	368	210	118	172	195	120	117,5-115,5-97,9
NR4 EI 32/160A-60, B-60	32	340	421	80	341	286	190	105	102	102	60	29,4-29,3
NR4 EI 32/200B-60, C-60	32	440	429	85	344	286	190	105	126	126	60	37,2-35,2
NR4 EI 32/200A-60/A	32	440	469	85	344	286	190	105	126	126	60	
NR4 EI 40/160A-60, B-60	40	320	430	81	349	286	190	105	119	119	75	37,9-37,4
NR4 EI 40/200B-60	40	440	430	81	349	286	190	105	140	140	75	45,9
NR4 EI 40/200A-60/A	40	440	470	81	349	286	190	105	140	140	75	49,4
NR4 EI 50/160B-60, C-60	50	340	440	90	350	286	190	105	120	128	75	41,9-39,9
NR4 EI 50/160A-60/B	50	340	480	90	350	286	190	105	120	128	75	43,9
NR4 EI 50/200A-60/B, B-60/B	50	440	516	100	416	294	190	105	140	140	80	62,4
NR4 EI 50/250C-60/B	50	440	516	100	416	294	190	105	175	175	85	83,9
NR4 EI 50/250A-60/A, B-60/B	50	440	545	100	445	368	210	118	175	175	85	101-86,4
NR4 EI 65/125D-60, F-60	65	340	454	105	349	286	190	105	121	145	95	45,4-43,4
NR4 EI 65/125A-60/B	65	340	494	105	349	286	190	105	121	145	95	48
NR4 EI 65/160A-60/B, B-60/B	65	340	504	105	399	294	190	105	121	142	95	49,1-48,9
NR4 EI 65/200C-60/B	65	475	536	105	431	294	190	105	140	153	90	58,4
NR4 EI 65/200B-60/B	65	475	536	105	431	294	190	105	140	153	90	66,4
NR4 EI 65/200A-60/B	65	475	552	105	447	368	210	118	175	175	90	70,9
NR4 EI 65/250C-60/B	65	475	555	105	450	365	210	118	175	175	90	81,9
NR4 EI 65/250A-60/A, B-60/A	65	475	555	105	450	368	210	118	175	175	90	105,5-92,5

Features - Características constructivas

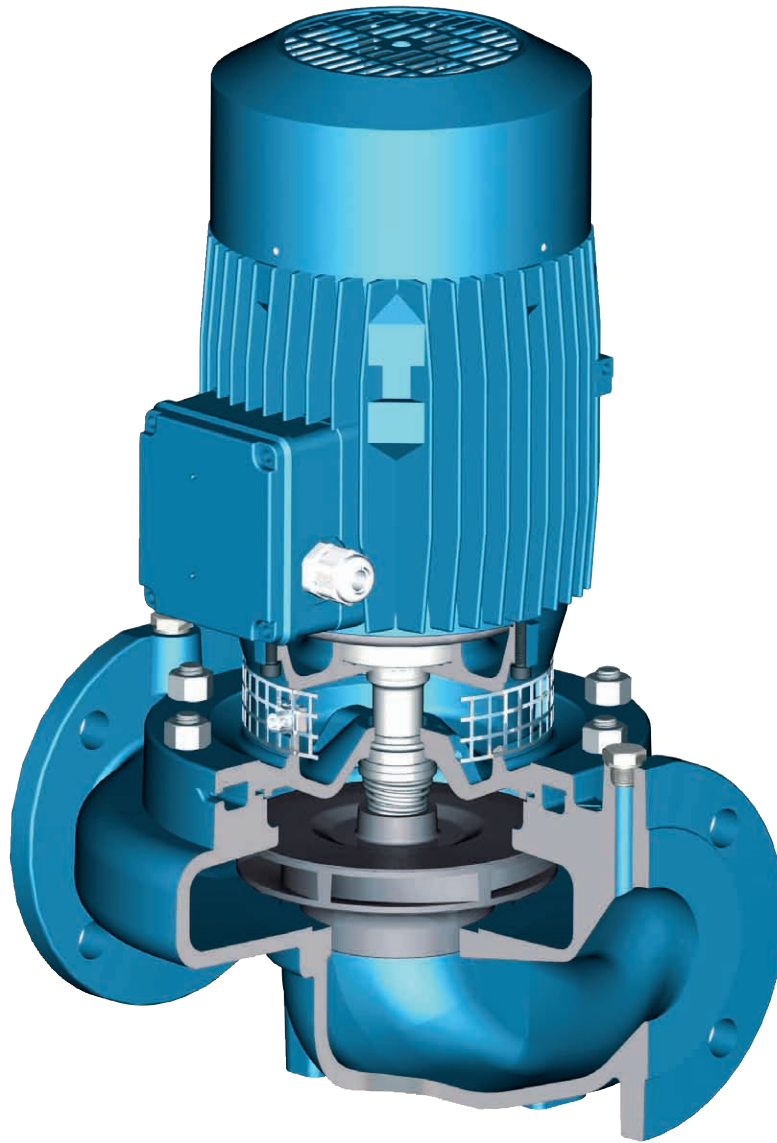

New Compact Design

A compact structure allows for simple installation even in confined spaces.

A Unique Design

An innovative guard (patented) prevents contact with rotating parts, providing protection to the end user whilst allowing for inspection of the mechanical seal.

Exceptional Fluid Dynamics

The fluid dynamics through the impeller and casing are designed to minimize losses and increase performance.

Advanced hydraulics

Optimum impeller geometry provides maximum efficiency and excellent suction characteristics.

Silent operation

Specially designed fluid ducts provide very quiet operation.

Nuevo diseño compacto

Una estructura compacta permite una sencilla instalación incluso en espacios reducidos.

Un diseño único

Un protector (patentado) evita el contacto con las partes en rotación, proporcionando protección al usuario final, mientras que permite la inspección del sello mecánico.

Dinámica de fluidos excepcionales

El dinamismo de la carcasa con el impulsor hacen mínimas las pérdidas y aumenta su rendimiento.

Avanzado sistema hidráulico

La geometría del impulsor proporciona la máxima eficiencia y excelente características de succión.

Funcionamiento silencioso

Diseño especial para la conducción de los fluidos hacen su funcionamiento muy silencioso.