

SDS 60 Hz



Submersible borehole pumps for 6", 8" and 10" wells
Bombas sumergibles para pozos de 6", 8" y 10"



Coverage chart - Campo de aplicaciones

$n \approx 3450$ 1/min

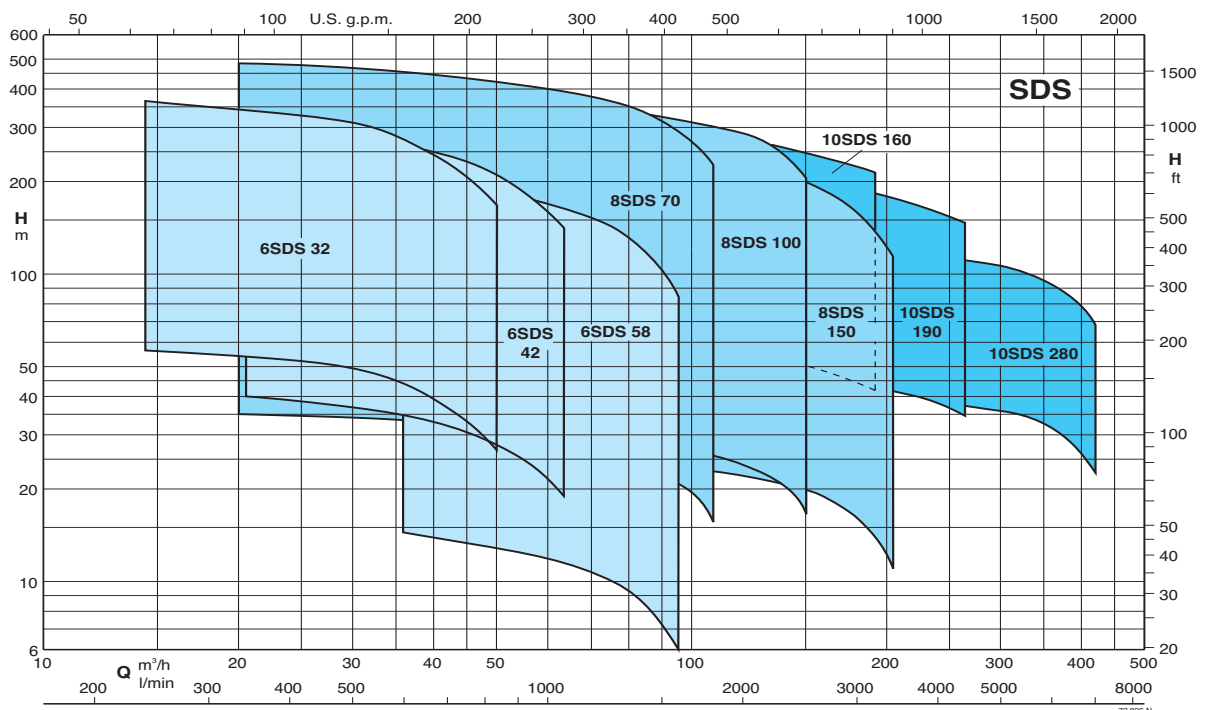

Construction

Submersible motor pumps for deep wells of 6" (DN 150 mm), 8" (DN 200 mm) and 10" (DN 250 mm), with stages in cast iron or in bronze, on request.

Impellers: - mixed flow impellers.

Connection: - screwed connection ISO 228 for 6SDS;

- flange with counter-flange for welding for 8SDS and 10SDS

Delivery casing with built-in non-return valve.

Applications

For water supply.

For civil and industrial applications.

For irrigation.

Operating conditions

Max. sand quantity into the water: 150 g/m³.

Continuous duty.

6", 8", 10" Rewindable motor CS series

2-pole induction motor, 60 Hz (n = 3450 rpm).

Sized for connection to the pumps according to NEMA Standards.

Standard voltages:

- three-phase 380 V, 440 V, 460 V; 380/660 V for 6-8-10" motors.

Voltage tolerance : ±10%.

Recommended type of starting for powers from 7.5 kW: star/delta, soft start, impedance starting, autotransformer.

Motor	Max. Liquid temperature	Cooling: minimum flow velocity	Max. starts per hour	Motor P2
6CS-R	30 °C	0,1 m/s	15	4÷11 kW
		0,2 m/s	15	13÷15 kW
	25 °C	0,2 m/s	15	18,5 kW
		0,2 m/s	13	22÷30 kW
	40 °C	0,1 m/s	13	37 kW
		0,3 m/s	6	45 kW
8CS-R	25 °C	0,3 m/s	10	30÷45 kW
			8	51÷75 kW
			6	92 kW
10CS	25 °C	0,50 m/s	10	all types

Insulation PVC coated wire for 6-8-10" motors.

Protection IP 68.

Cable: 6CS length 3,5 m, 8CS length 4 m, 10CS length 6 m.

Special features on request

- Other voltages.

- Other temperatures.

Materials

Components	6, 8, 10SDS	B-6, B-8, B-10SDS
Stage casing Diffuser Impeller	Cast iron GJL 200 EN 1561	Bronze G-Cu Sn 10 EN 1982
Wear ring	Rubber (Bronze for 10SDS 190-280)	
Shaft	6SDS e 8SDS: Steel AISI F51duplex 10SDS Cr steel AISI 420	Cr-Ni-Mo steel AISI 316
Shaft sleeve	Brass with chromate surface treatment (only for 10SDS)	
Delivery casing Suction lantern	Cast iron GJL 200 EN 1561	Bronze G-Cu Sn 10 EN 1982
Bearing bush	Rubber	
Strainer	Cr-Ni steel AISI 304	
Screws	Cr-Ni steel AISI 304	

Ejecución

Electrobombas sumergibles para pozos profundos 6" (DN 150 mm), 8" (DN 200 mm) y 10" (DN 250 mm), con etapas en hierro o en bronce, bajo demanda.

Rodetes: - semi-axiales

Conexión: - Boca roscada ISO 228 para 6SDS.

- Dridas con contrabridas para soldar 8SDS, 10SDS

Válvula de retención incorporada en el cuerpo de impulsión.

Aplicaciones

Para suministros de agua.

Para aplicaciones civiles e industriales.

Para riegos en general.

Limites de empleo

Máxima cantidad de arena en el agua: 150 g/m³.

Servicio continuo.

Motor rebobinable serie CS 6", 8", 10"

Motor a inducción 2 polos, 60 Hz (n = 3450 1/min).

Dimensiones para el acoplamiento a la bomba según NEMA Standard.

Tensiones de alimentación:

- trifásicos 380 V, 440 V, 460 V; 380/660, para motores de 6-8-10".

Variación de tensión : ±10%.

Tipo de arranque aconsejado para potencias desde 7.5kW:

estrella/triángulo, soft start, con impedancia, autotransformador.

Motores	Temperatura del agua hasta	Refrigeración: velocidad mínima del caudal	Arranques por hora máximos	Motores P2
6CS-R	30 °C	0,1 m/s	15	4÷11 kW
		0,2 m/s	15	13÷15 kW
	25 °C	0,2 m/s	15	18,5 kW
		0,2 m/s	13	22÷30 kW
	40 °C	0,1 m/s	13	37 kW
		0,3 m/s	6	45 kW
8CS-R	25 °C	0,3 m/s	10	30÷45 kW
			8	51÷75 kW
			6	92 kW
10CS	25 °C	0,50 m/s	10	todos

Aislamiento: hilo con revestimiento en PVC para 6-8-10" motor.

Protección IP 68.

Cable 6CS Longitud 3,5 m, 8CS Longitud 4 m, 10CS Longitud 6 m.

Ejecuciones especiales bajo demanda

- Otras tensiones.

- Otras temperaturas.

Materiales

Componentes	6, 8, 10SDS	B-6, B-8, B-10SDS
Cuerpo elemento Difusor Rodete	Hierro GJL 200 EN 1561	Bronze G-Cu Sn 10 EN 1982
Anillo de cierre	Goma (Bronze para 10SDS 190-280)	
Eje	6SDS y 8SDS: Acero F51 duplex 10SDS: Acero Cr AISI 420	Acero Cr-Ni-Mo AISI 316
Camisa del eje	Latón con la superficie cromada (solamente para 10SDS)	
Cuerpo de impulsión Lanternas de aspiración	Hierro GJL 200 EN 1561	Bronze G-Cu Sn 10 EN 1982
Cojinete guía	Goma	
Filtro	Acero Cr-Ni AISI 304	
Tornillo	Acero Cr-Ni AISI 304	

6SDS 32 60 Hz



Performance - Prestaciones $n \approx 3450$ rpm, dimensions and weights - dimensiones y pesos

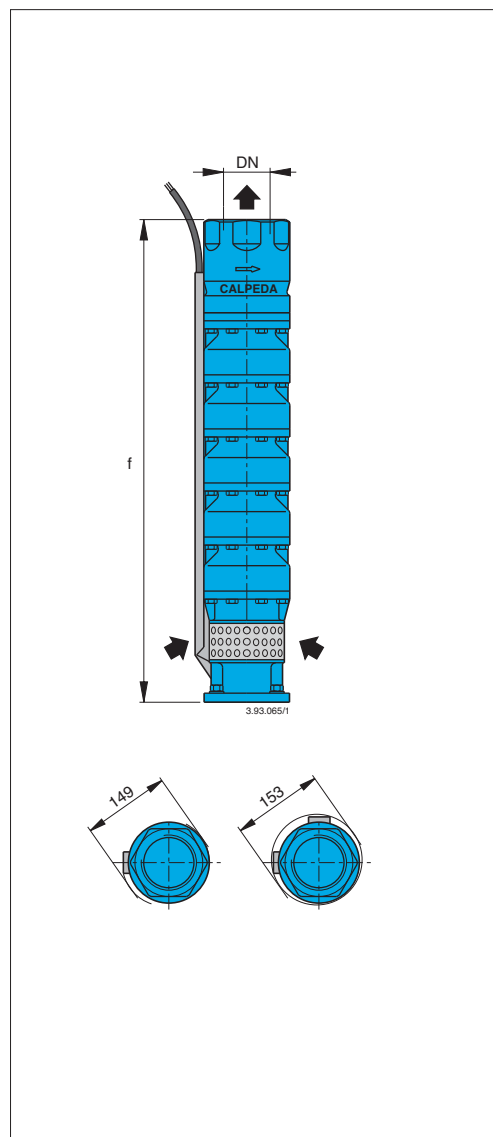
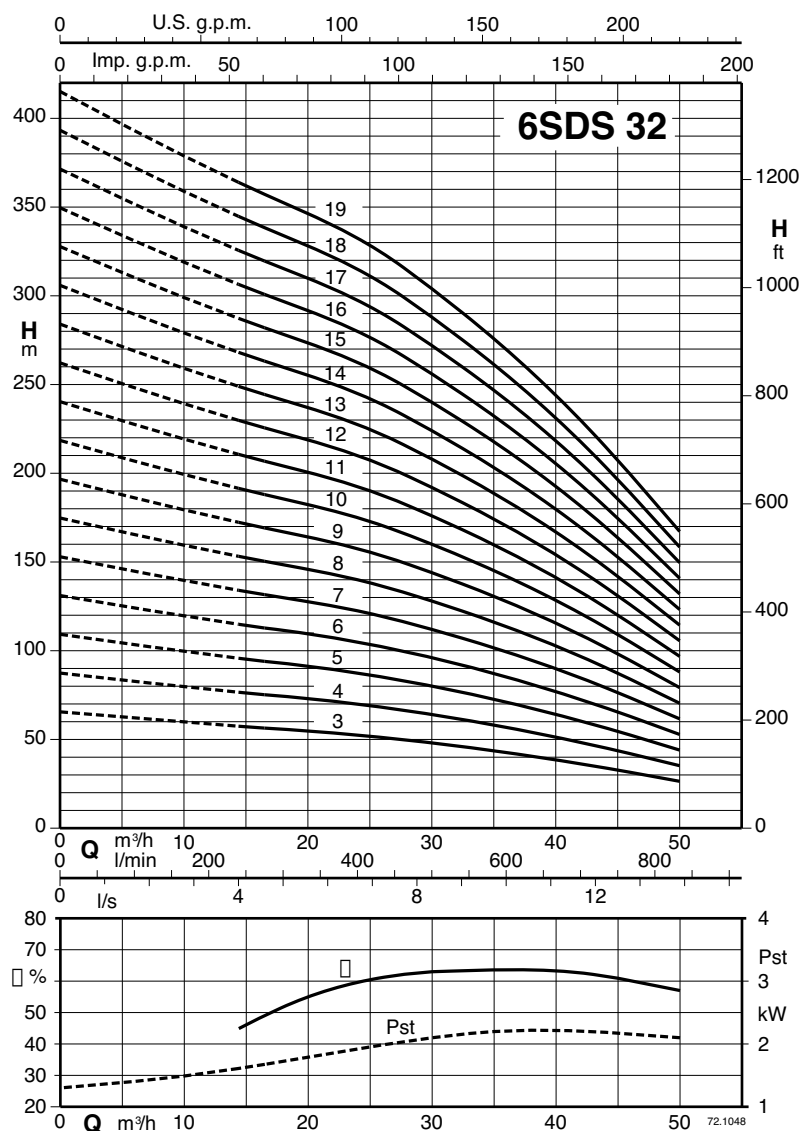

3 ~	P ₂		Q	n ≈ 3450 rpm										
				m³/h										
	kW	HP		l/min	0	14,4	24	30	36	42	46	50		
6SDS 32/3-60 - B-6SDS 32/3-60	7,5	10	H m	66	57,5	52,5	48	43	36	31,5	26,5			
6SDS 32/4-60 - B-6SDS 32/4-60	11	15		88	76,5	70	64	57	48,5	42	35			
6SDS 32/5-60 - B-6SDS 32/5-60	11	15		110	96	87,5	80	71	60,5	52,5	44			
6SDS 32/6-60 - B-6SDS 32/6-60	13	17,5		132	115	105	96	85	73	63	53			
6SDS 32/7-60 - B-6SDS 32/7-60	15	20		154	134	123	112	99,5	85	73,5	62			
6SDS 32/8-60 - B-6SDS 32/8-60	18,5	25		176	153	140	128	114	97	84	70,5			
6SDS 32/9-60 - B-6SDS 32/9-60	18,5	25		198	172	158	144	128	109	94,5	79			
6SDS 32/10-60 - B-6SDS 32/10-60	22	30		220	191	175	160	142	121	105	88			
6SDS 32/11-60 - B-6SDS 32/11-60	22	30		242	210	193	176	156	133	115	97			
6SDS 32/12-60 - B-6SDS 32/12-60	26	35		264	229	210	192	170	145	126	106			
6SDS 32/13-60 - B-6SDS 32/13-60	26	35		286	248	228	208	185	157	136	114			
6SDS 32/14-60 - B-6SDS 32/14-60	30	40		308	267	245	224	199	169	147	123			
6SDS 32/15-60 - B-6SDS 32/15-60	30	40		330	287	263	240	213	181	157	132			
6SDS 32/16-60 - B-6SDS 32/16-60	37	50		352	306	280	256	227	194	168	141			
6SDS 32/17-60 - B-6SDS 32/17-60	37	50		374	325	298	272	241	206	178	149			
6SDS 32/18-60 - B-6SDS 32/18-60	45	60		396	344	315	288	256	218	189	159			
6SDS 32/19-60 - B-6SDS 32/19-60	45	60		418	363	333	304	270	230	200	167			

DN	Ø M	f	6SDS	B-6SDS
	mm	mm	kg	kg
G 3 ISO 228	145 6"	686	30,5	35,5
		788	35,6	41,6
		890	41	49
		992	46	55
		1094	52,3	62,3
		1196	57	68
		1298	62,5	74,5
		1400	68,5	81,5
		1502	72,5	86,5
		1604	77,5	93,5
		1706	84	101
		1808	89	108
1910	94,2	112		
2012	100	119		
2114	105	125		
2216	111	132		
2318	116	139		

P₂ Rated motor power output.
Potencia nominal del motor.

H Total head in m
Altura total en m

Tolerances according to UNI EN ISO 9906:2012.
Tolerancias según UNI EN ISO 9906:2012.

6SDS 42 60 Hz



Performance - Prestaciones $n \approx 3450$ rpm, dimensions and weights - dimensiones y pesos

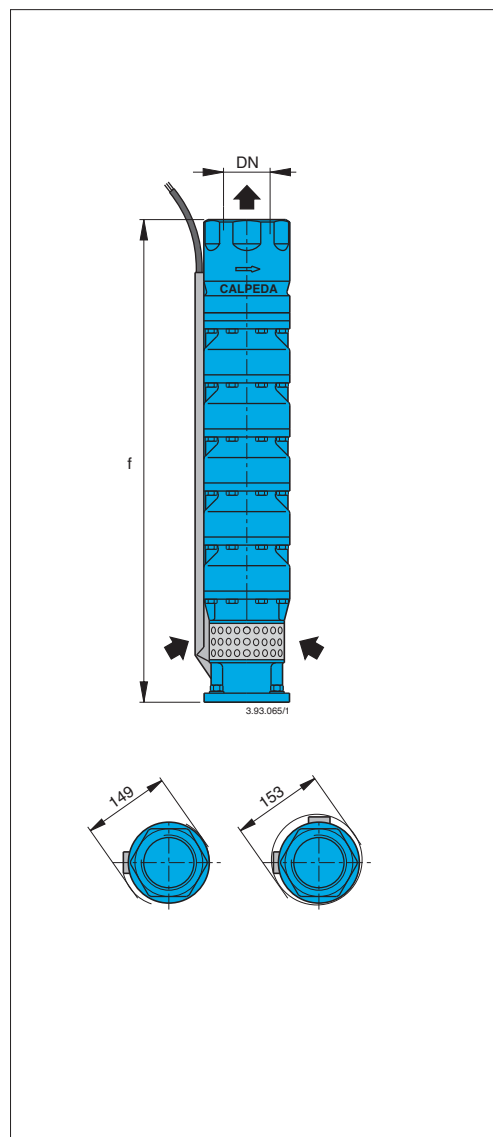
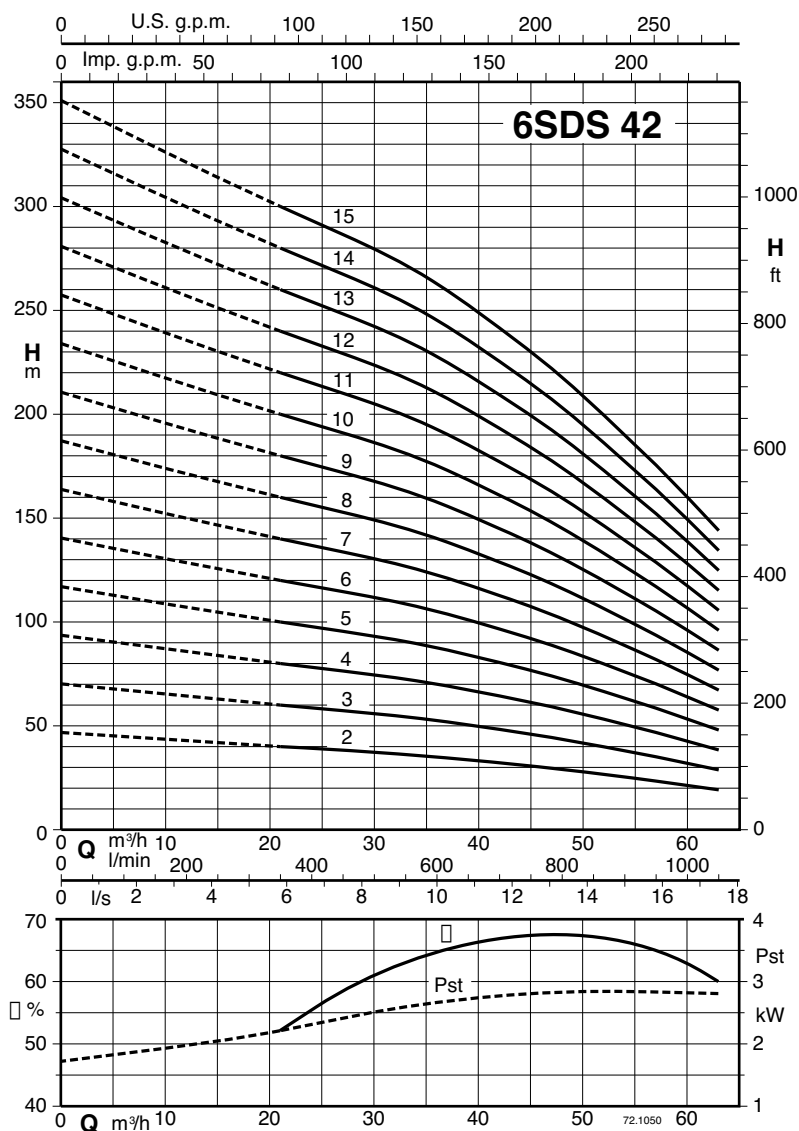

3 ~	P ₂		Q	n ≈ 3450 rpm										
				H										
	kW	HP		m³/h	0	21	27	32	37	42	47	52	57	63
6SDS 42/2-60 - B-6SDS 42/2-60	7,5	10	l/min	0	350	450	533	616	700	783	866	950	1050	
6SDS 42/3-60 - B-6SDS 42/3-60	11	15	46	40	38	36,5	34,5	32	29,5	26,5	23,5	19		
6SDS 42/4-60 - B-6SDS 42/4-60	11	15	70	60	57,5	55	52	48	44,5	40	35	29		
6SDS 42/5-60 - B-6SDS 42/5-60	15	20	93	80	76,5	73	69	64,5	59	53	47	38,5		
6SDS 42/6-60 - B-6SDS 42/6-60	18,5	25	116	100	95,5	91,5	86,5	80,5	74	66,5	58,5	48		
6SDS 42/7-60 - B-6SDS 42/7-60	18,5	25	140	120	115	110	104	96,5	89	80	70	57,5		
6SDS 42/8-60 - B-6SDS 42/8-60	22	30	163	140	134	128	121	113	103	93	82	67		
6SDS 42/9-60 - B-6SDS 42/9-60	26	35	186	160	153	146	138	129	118	106	93,5	77		
6SDS 42/10-60 - B-6SDS 42/10-60	30	40	209	180	172	165	156	145	133	120	105	86,5		
6SDS 42/11-60 - B-6SDS 42/11-60	30	40	233	200	191	183	173	161	148	133	117	96		
6SDS 42/12-60 - B-6SDS 42/12-60	37	50	256	220	210	201	190	177	163	146	129	105		
6SDS 42/13-60 - B-6SDS 42/13-60	37	50	280	240	229	219	208	193	177	159	140	115		
6SDS 42/14-60 - B-6SDS 42/14-60	45	60	302	260	248	238	225	209	192	173	152	125		
6SDS 42/15-60 - B-6SDS 42/15-60	45	60	326	280	267	256	242	225	207	186	164	134		
			349	300	286	274	259	241	222	199	175	144		

DN	Ø M	f	6SDS	B-6SDS
	mm	mm	kg	kg
G 3 ISO 228	145 6"	584	25,5	29,5
		686	31,6	36,6
		788	36	42
		890	40,3	48,3
		992	47	59
		1094	50,5	65,5
		1196	55,5	66,5
		1298	62,5	74,5
		1400	69	81
		1502	74	86
				1604
		1706	83,2	99,2
		1808	91,4	106
		1910	96,4	113

P₂ Rated motor power output.
Potencia nominal del motor.

H Total head in m
Altura total en m

Tolerances according to UNI EN ISO 9906:2012.
Tolerancias según UNI EN ISO 9906:2012.

6SDS 58 60 Hz



Performance - Prestaciones $n \approx 3450$ rpm, dimensions and weights - dimensiones y pesos

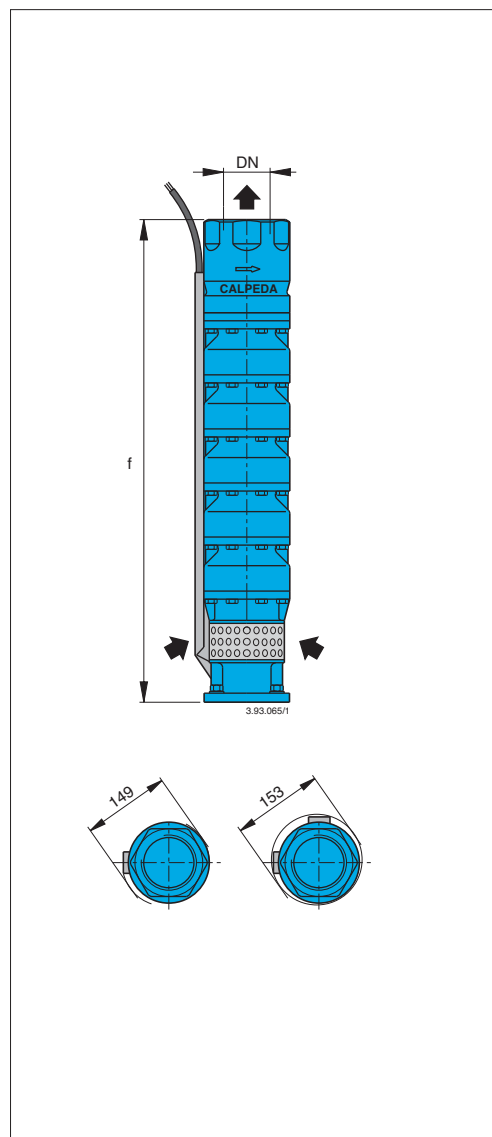
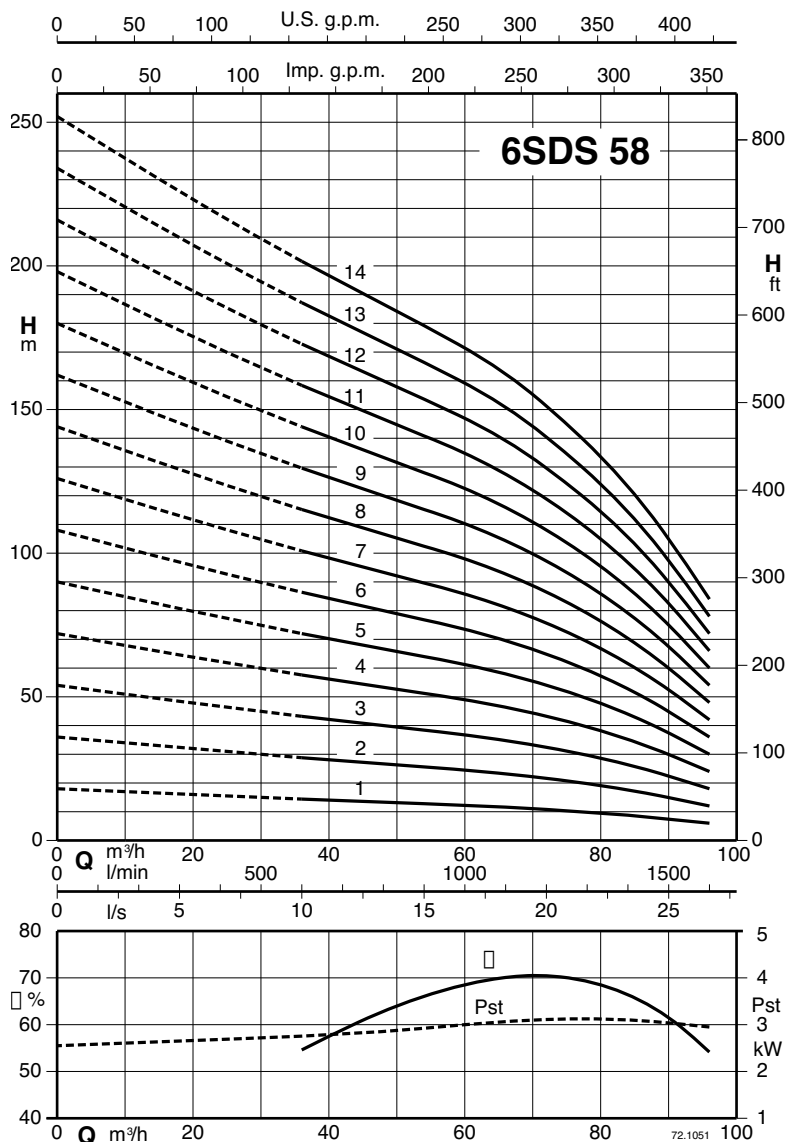

3 ~	P ₂		Q	n ≈ 3450 rpm											
				H											
	kW	HP	m³/h	0	36	48	54	60	66	72	78	84	96		
6SDS 58/1-60 - B-6SDS 58/1-60	3,7	5	l/min	0	600	800	900	1000	1100	1200	1300	1400	1600		
6SDS 58/2-60 - B-6SDS 58/2-60	5,5	7,5	H m	18	14,5	13	13	12	11,5	10,5	9,5	8,5	6		
6SDS 58/3-60 - B-6SDS 58/3-60	11	15		36	29	26,5	26	24,5	23	21,5	19,5	17,5	12		
6SDS 58/4-60 - B-6SDS 58/4-60	11	15		54	43	40	38,5	36,5	35	32,5	29,5	26,5	18		
6SDS 58/5-60 - B-6SDS 58/5-60	15	20		72	57,5	53	51	49	46,5	43	39	35	24		
6SDS 58/6-60 - B-6SDS 58/6-60	18,5	25		90	72	66	64	61	58	54	49	44	30		
6SDS 58/7-60 - B-6SDS 58/7-60	22	30		108	86,5	79	77	73	70	65	59	53	36		
6SDS 58/8-60 - B-6SDS 58/8-60	22	30		126	101	92,5	90	85,5	81	75,5	68,5	61,5	42		
6SDS 58/9-60 - B-6SDS 58/9-60	26	35		144	115	106	102	98	93	86,5	78,5	70,5	48		
6SDS 58/10-60 - B-6SDS 58/10-60	30	40		162	130	119	115	110	104	97	88	79	54		
6SDS 58/11-60 - B-6SDS 58/11-60	37	50		180	144	132	128	122	116	108	98	88	60		
6SDS 58/12-60 - B-6SDS 58/12-60	37	50		198	158	145	141	134	128	119	108	97	66		
6SDS 58/13-60 - B-6SDS 58/13-60	45	60		216	173	158	154	146	139	130	118	106	72		
6SDS 58/14-60 - B-6SDS 58/14-60	45	60		234	187	172	166	159	151	140	127	114	78		
				252	202	185	179	171	162	151	137	123	84		

DN	Ø M	f	6SDS	B-6SDS
	mm	mm	kg	kg
G 4 ISO 228	145 6"	482	21,3	22,4
		584	26,5	29,5
		686	31,6	36,6
		788	37	43
		890	43,3	50,3
		992	48	57
		1094	53,5	63,5
		1196	59,5	70,5
		1298	65	77
		1400	71	84
		1502	76,2	90,2
1604	82,2	97,2		
1706	87,4	104		
1808	93,4	111		

P₂ Rated motor power output.
Potencia nominal del motor.

H Total head in m
Altura total en m

Tolerances according to UNI EN ISO 9906:2012.
Tolerancias según UNI EN ISO 9906:2012.

8SDS 70 60 Hz



Performance - Prestaciones $n \approx 3450$ rpm, dimensions and weights - dimensiones y pesos

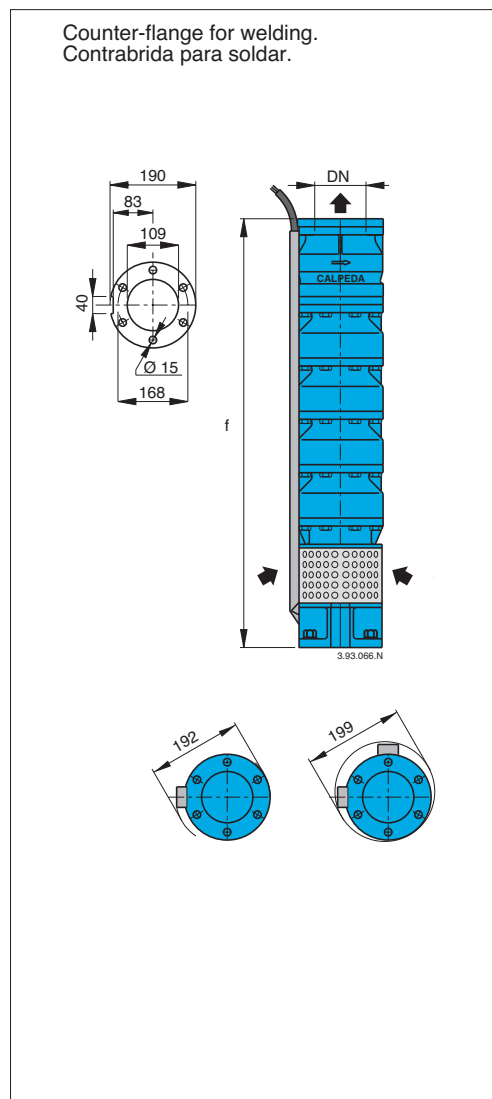
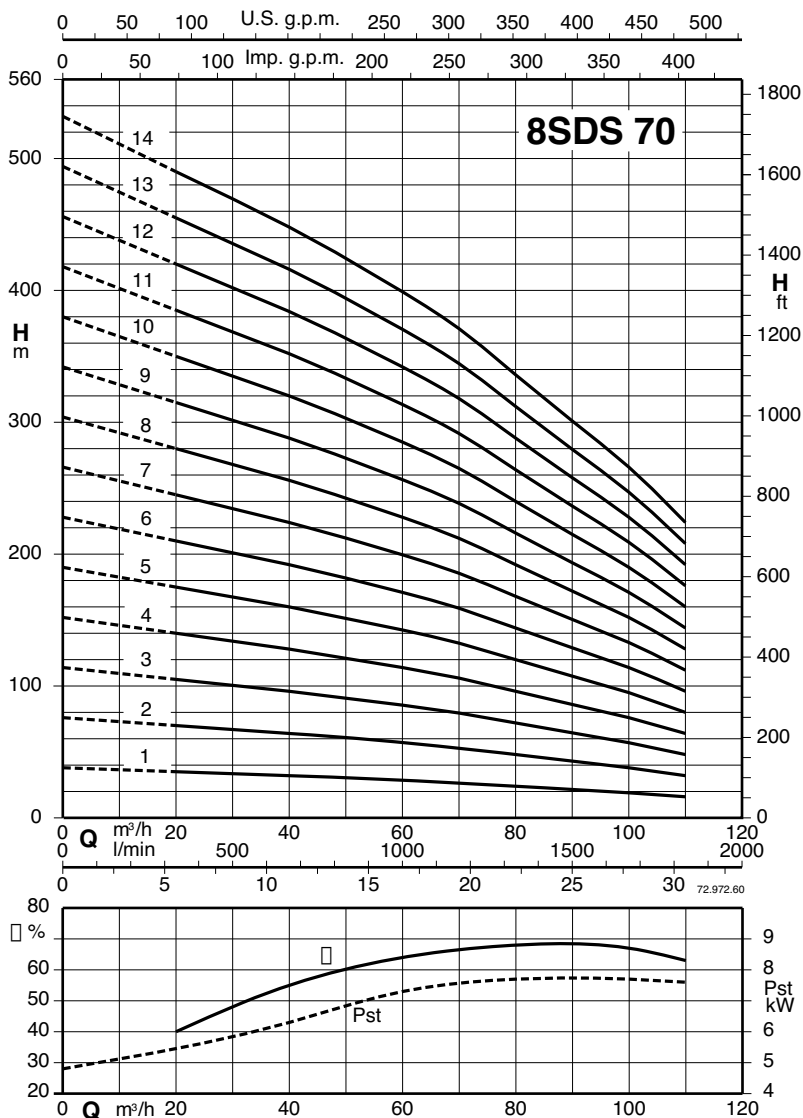

3 ~	P ₂		Q	n ≈ 3450 rpm										
				m³/h										
				0	20	40	50	60	70	80	90	100	110	
kW HP		l/min	0	333	666	833	1000	1166	1333	1500	1666	1833		
8SDS 70/1-60 - B-8SDS 70/1-60	7,5	10	H m	38	35	32	30,5	28,5	26,5	24	21,5	19	16	
8SDS 70/2-60 - B-8SDS 70/2-60	15	20		76	70	64	61	57	53	48	43	38	32	
8SDS 70/3-60 - B-8SDS 70/3-60	26	35		114	105	96	91,5	85,5	79,5	72	64,5	57	48	
8SDS 70/4-60 - B-8SDS 70/4-60	30	40		152	140	128	122	114	106	96	86	76	64	
8SDS 70/5-60 - B-8SDS 70/5-60	37	50		190	175	160	153	143	133	120	108	95	80	
8SDS 70/6-60 - B-8SDS 70/6-60	45	60		228	210	192	183	171	159	144	129	114	96	
8SDS 70/7-60 - B-8SDS 70/7-60	55	75		266	245	224	214	200	186	168	151	133	112	
8SDS 70/8-60 - B-8SDS 70/8-60	59	80		304	280	256	244	228	212	192	172	152	128	
8SDS 70/9-60 - B-8SDS 70/9-60	66	90		342	315	288	275	257	239	216	194	171	144	
8SDS 70/10-60 - B-8SDS 70/10-60	75	100		380	350	320	305	285	265	240	215	190	160	
8SDS 70/11-60 - B-8SDS 70/11-60	92	125		418	385	352	336	314	292	264	237	209	176	
8SDS 70/12-60 - B-8SDS 70/12-60	92	125		456	420	384	366	342	318	288	258	228	192	
8SDS 70/13-60 - B-8SDS 70/13-60	92	125		494	455	416	397	371	345	312	280	247	208	
8SDS 70/14-60 - B-8SDS 70/14-60	110	150		532	490	448	427	399	371	336	301	266	224	

DN	Ø M	f	8SDS	B-8SDS
	mm	mm	kg	kg
100	145 6"	602	38	43
		734	49	55,5
		866	60	68
		998	71,5	80,5
		1130	82,5	93
		1262	93,5	106
150	191 8"	1394	105	118
		1526	116	131
		1658	127	143
		1790	138	156
		1922	149	168
		2054	160	181
200	240 10"	2186	171	194
		2318	182	206

P₂ Rated motor power output.
Potencia nominal del motor.

H Total head in m
Altura total en m

Tolerances according to UNI EN ISO 9906:2012.
Tolerancias según UNI EN ISO 9906:2012.

8SDS 100 60 Hz



Performance - Prestaciones $n \approx 3450$ rpm, dimensions and weights - dimensiones y pesos

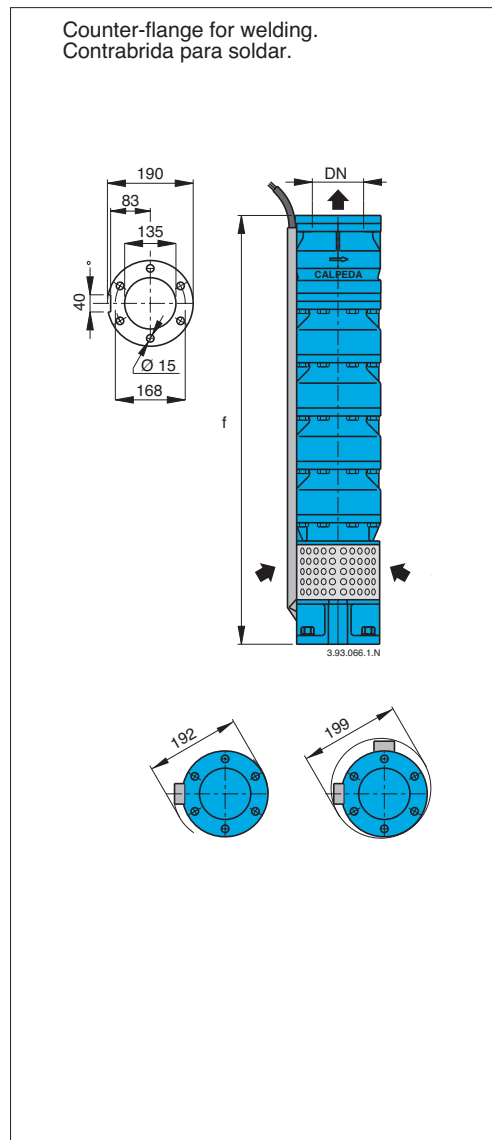
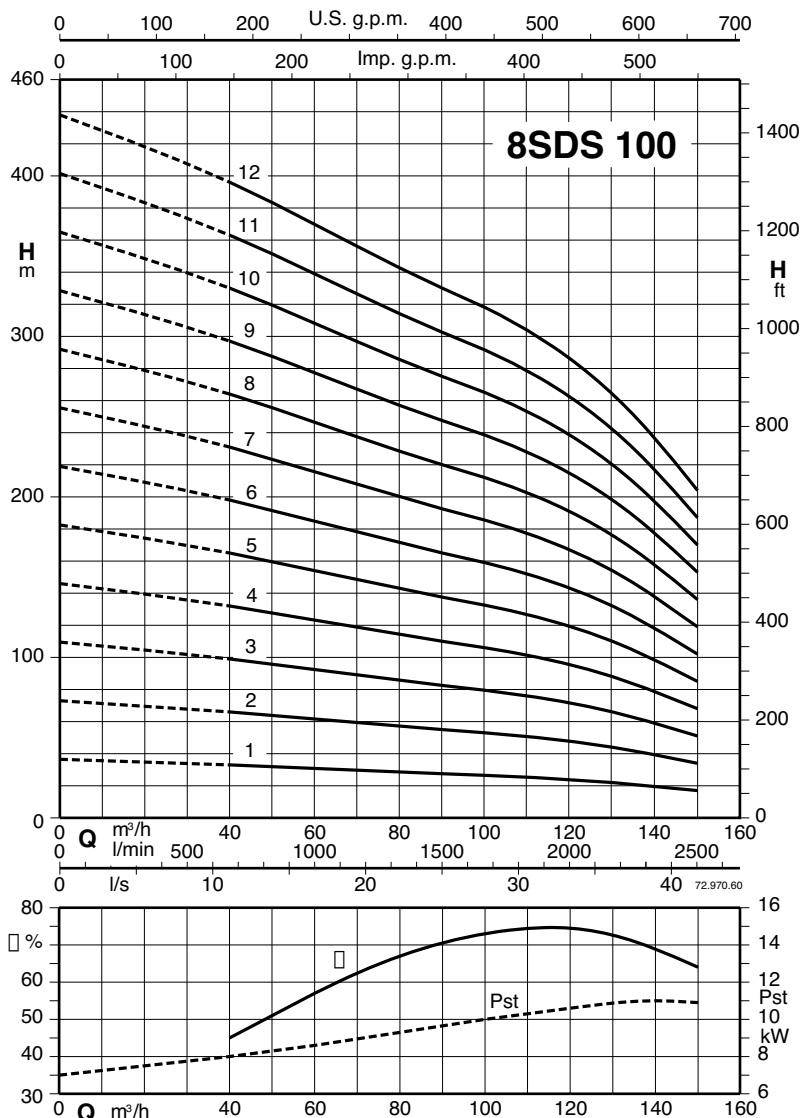

3 ~	P2		Q	$n \approx 3450$ rpm											
				m³/h	$n \approx 3450$ rpm										
					0	40	60	70	80	90	100	110	120	130	150
		l/min	0	666	1000	1166	1333	1500	1666	1833	2000	2166	2500		
8SDS 100/1-60 - B-8SDS 100/1-60	11	15	H m	36	33	30,5	29,5	28,5	27,5	26,5	25,5	24	22	17	
8SDS 100/2-60 - B-8SDS 100/2-60	22	30		73	66	61	59	57	55	53	51	48	44	34	
8SDS 100/3-60 - B-8SDS 100/3-60	30	40		109	99	91,5	88,5	85,5	82,5	79,5	76,5	72	66	51	
8SDS 100/4-60 - B-8SDS 100/4-60	45	60		146	132	122	118	114	110	106	102	96	88	68	
8SDS 100/5-60 - B-8SDS 100/5-60	51	70		183	165	153	148	143	138	133	128	120	110	85	
8SDS 100/6-60 - B-8SDS 100/6-60	59	80		220	198	183	177	171	165	159	153	144	132	102	
8SDS 100/7-60 - B-8SDS 100/7-60	75	100		256	231	214	207	200	193	186	179	168	154	119	
8SDS 100/8-60 - B-8SDS 100/8-60	92	125		293	264	244	236	228	220	212	204	192	176	136	
8SDS 100/9-60 - B-8SDS 100/9-60	92	125		329	297	275	266	257	248	239	230	216	198	153	
8SDS 100/10-60 - B-8SDS 100/10-60	110	150		366	330	305	295	285	275	265	255	240	220	170	
8SDS 100/11-60 - B-8SDS 100/11-60	132	180		402	363	336	325	314	303	292	281	264	242	187	
8SDS 100/12-60 - B-8SDS 100/12-60	132	180		440	396	366	354	342	330	318	306	288	264	204	

DN	Ø M	f	8SDS	B-8SDS
	mm	mm	kg	kg
125	145 6"	602	38	43
		734	49	55,5
		866	60	68
		998	71,5	80,5
		1130	82,5	93
		1262	93,5	106
	191 8"	1394	105	118
		1526	116	131
		1658	127	143
		1790	138	156
		1922	149	168
		205	160	181

P2 Rated motor power output.
Potencia nominal del motor.

H Total head in m
Altura total en m

Tolerances according to UNI EN ISO 9906:2012.
Tolerancias según UNI EN ISO 9906:2012.

8SDS 150 60 Hz



Performance - Prestaciones $n \approx 3450$ rpm, dimensions and weights - dimensiones y pesos

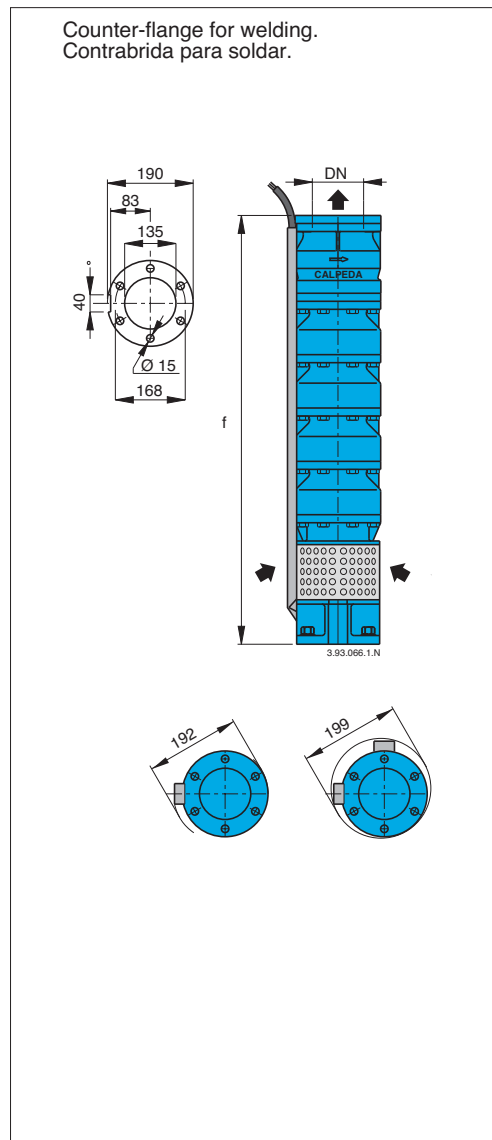
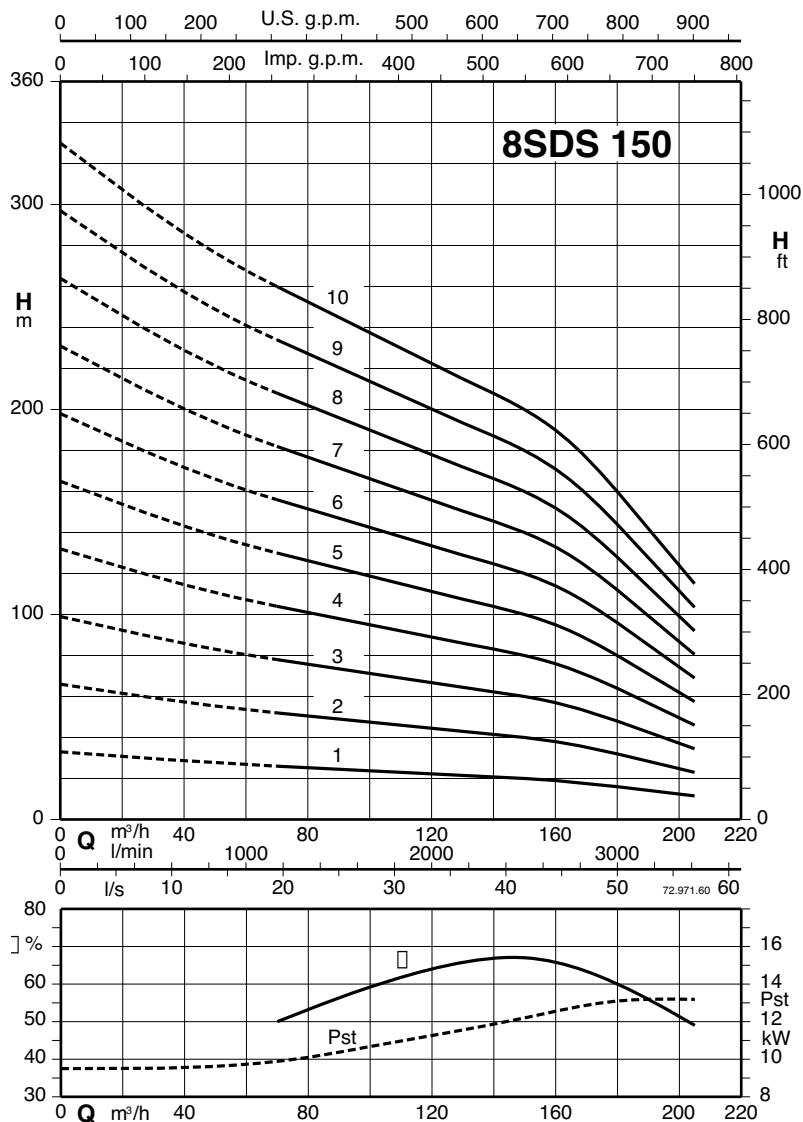

3 ~	P ₂		Q	n ≈ 3450 rpm										
				m³/h										
				0	70	90	110	120	130	140	150	160	180	205
	kW	HP	l/min	0	1166	1500	1833	2000	2166	2333	2500	2666	3000	3416
8SDS 150/1-60 - B-8SDS 150/1-60	15	20	H m	33	26	24,5	22,5	22	21,5	20,5	20	19	16	11,5
8SDS 150/2-60 - B-8SDS 150/2-60	30	40		66	52	49	45	44	43	41	40	38	32	23
8SDS 150/3-60 - B-8SDS 150/3-60	45	60		100	78	73,5	67,5	66	64,5	61,5	60	57	48	34,5
8SDS 150/4-60 - B-8SDS 150/4-60	51	70		133	104	98	90	88	86	82	80	76	64	46
8SDS 150/5-60 - B-8SDS 150/5-60	66	90		166	130	123	113	110	108	103	100	95	80	57,5
8SDS 150/6-60 - B-8SDS 150/6-60	75	100		199	156	147	135	132	129	123	120	114	96	69
8SDS 150/7-60 - B-8SDS 150/7-60	92	125		233	182	172	158	154	151	144	140	133	112	80,5
8SDS 150/8-60 - B-8SDS 150/8-60	92	125		266	208	196	180	176	172	164	160	152	128	92
8SDS 150/9-60 - B-8SDS 150/9-60	110	150		299	234	221	203	198	194	185	180	171	144	104
8SDS 150/10-60 - B-8SDS 150/10-60	132	180		333	260	245	225	220	215	205	200	190	160	115

DN	Ø M	f	8SDS	B-8SDS
	mm	mm	kg	kg
125	145 6"	602	38	43
		734	49	55,5
	191 8"	866	60	68
		998	71,5	80,5
		1130	82,5	93
		1262	93,5	106
240 10"	1394	105	118	
	1526	116	131	
		1658	127	143
		1790	138	156

P₂ Rated motor power output.
Potencia nominal del motor.

H Total head in m
Altura total en m

Tolerances according to UNI EN ISO 9906:2012.
Tolerancias según UNI EN ISO 9906:2012.

10SDS 160 60 Hz



Performance - Prestaciones $n \approx 3450$ rpm, dimensions and weights - dimensiones y pesos

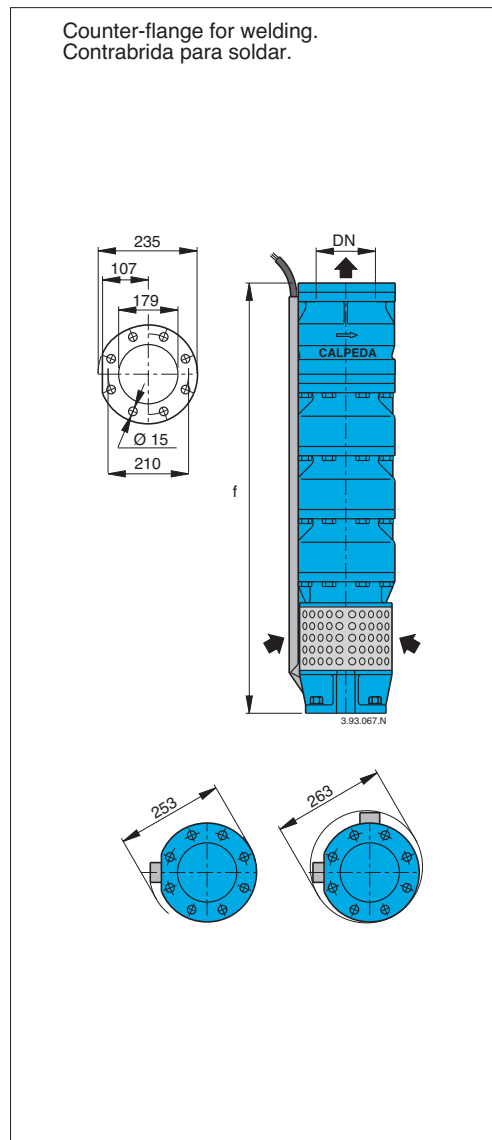
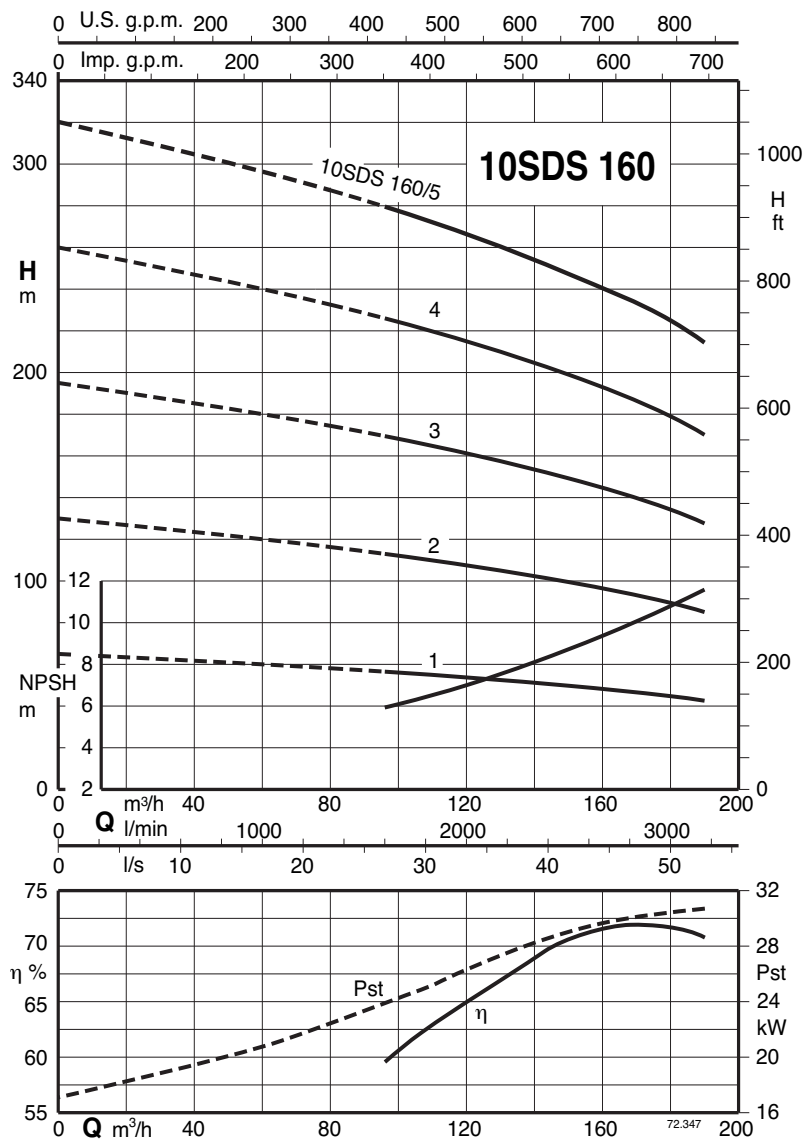

3 ~	P ₂		Q	n ≈ 3450 rpm									
				m ³ /h									
	kW	HP		0	96	120	150	160	168	175	180	192	
10SDS 160/1-60 - B-10SDS 160/1-60	37	50	H m	64	55	53	49	48	47	46	45	43	
10SDS 160/2-60 - B-10SDS 160/2-60	75	100		128	110	106	98	96	94	92	90	86	
10SDS 160/3-60 - B-10SDS 160/3-60	110	150		192	165	159	147	144	141	138	135	129	
10SDS 160/4-60 - B-10SDS 160/4-60	132	180		256	220	212	196	192	188	184	180	172	
10SDS 160/5-60 - B-10SDS 160/5-60	150	200		320	275	265	245	240	235	230	225	215	

DN	Ø M	f	10SDS	B-10SDS
	mm	mm	kg	kg
175	145 6"	865	77	87
	191 8"	1035	103	114
	240 10"	1205	126	141
		1375	150	169
		1545	174	197

P₂ Rated motor power output.
Potencia nominal del motor.

H Total head in m
Altura total en m

Tolerances according to UNI EN ISO 9906:2012.
Tolerancias según UNI EN ISO 9906:2012.

10SDS 190 60 Hz



Performance - Prestaciones $n \approx 3450$ rpm, dimensions and weights - dimensiones y pesos

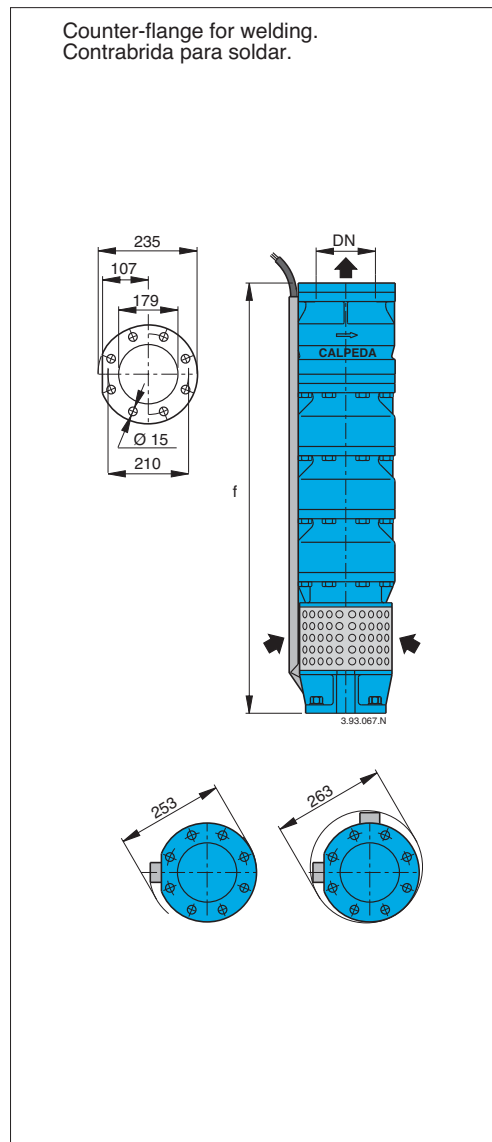
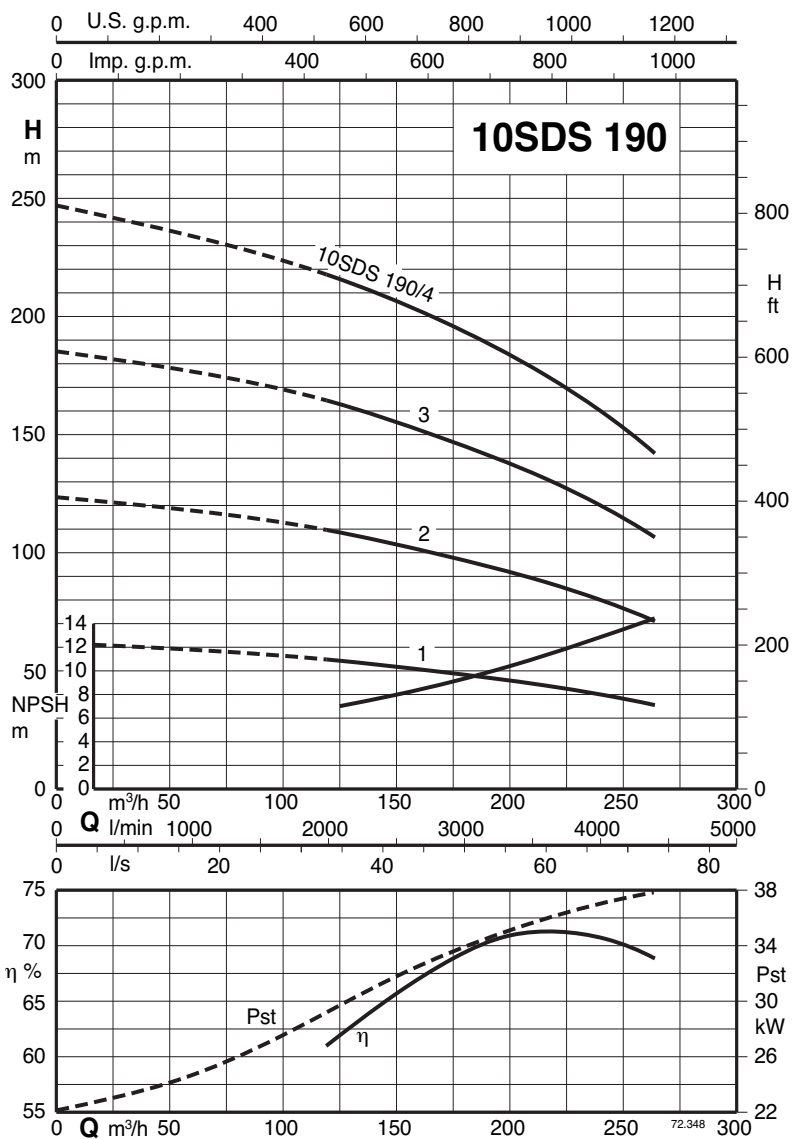

3 ~	P ₂		Q	n ≈ 3450 rpm								
	kW	HP	m³/h	0	120	168	192	216	240	264		
					l/min	0	2000	2800	3200	3600	4000	4400
10SDS 190/1-60 - B-10SDS 190/1-60	37	50	H m	62	55	49	46	41	39	35		
10SDS 190/2-60 - B-10SDS 190/2-60	75	100		124	110	99	92	83	78	69		
10SDS 190/3-60 - B-10SDS 190/3-60	110	150		185	164	150	138	125	116	104		
10SDS 190/4-60 - B-10SDS 190/4-60	150	200		247	219	199	184	166	155	149		

DN	Ø M	f	10SDS	B-10SDS
	mm	mm	kg	kg
175	145 6"	865	78	88
	191 8"	1035	102	115
	240 10"	1205	127	143
		1375	151	170

P₂ Rated motor power output.
Potencia nominal del motor.

H Total head in m
Altura total en m

Tolerances according to UNI EN ISO 9906:2012.
Tolerancias según UNI EN ISO 9906:2012.

10SDS 280 60 Hz



Performance - Prestaciones $n \approx 3450$ rpm, dimensions and weights - dimensiones y pesos

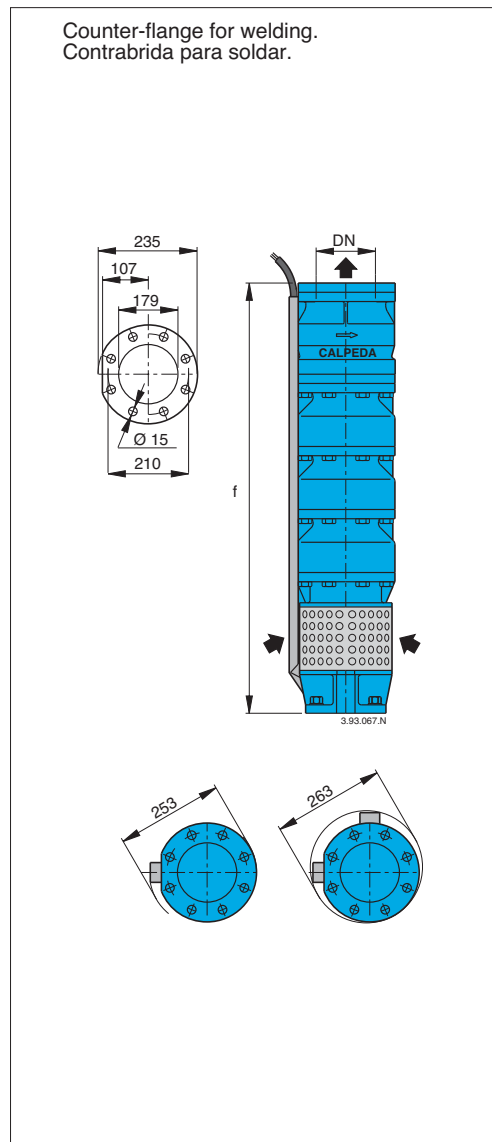
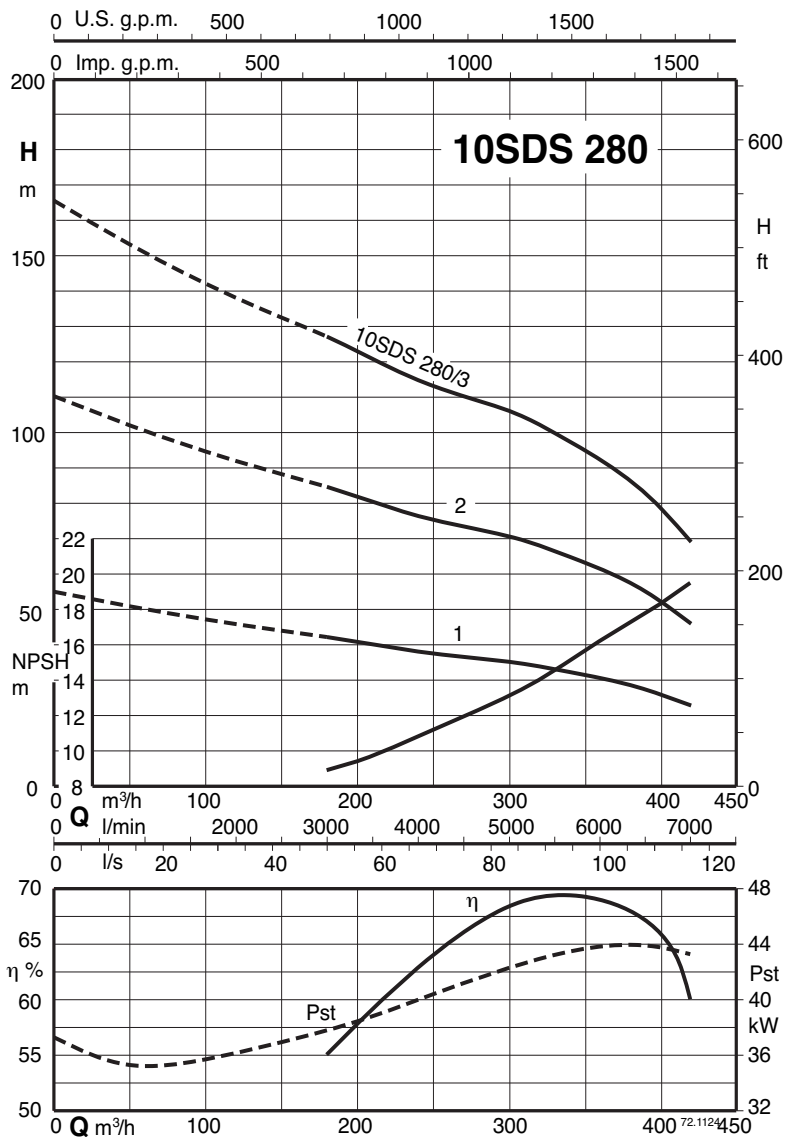

3 ~	P ₂		Q	n ≈ 3450 rpm									
				0	180	240	280	300	320	340	380	420	
	kW	HP	m³/h	l/min	0	3000	4000	4667	5000	5333	5667	6333	7000
10SDS 280/1-60 - B-10SDS 280/1-60	45	60	H m	55	43	38	37	36	34	33	29	23	
10SDS 280/2-60 - B-10SDS 280/2-60	92	125		110	85	77	73	71	68	65	58	46	
10SDS 280/3-60 - B-10SDS 280/3-60	132	180		165	128	115	109	107	103	98	87	69	

DN	Ø M	f	10SDS	B-10SDS
	mm	mm	kg	kg
175	145 6"	831	78	88
	191 8"	1029	103	116
	240 10"	1199	127	143

P₂ Rated motor power output.
Potencia nominal del motor.

H Total head in m
Altura total en m

Tolerances according to UNI EN ISO 9906:2012.
Tolerancias según UNI EN ISO 9906:2012.

Cables connection kit - Kit para empalme de cables

It allows connection of electric cables with junction submerged in water.

The kit includes:

- 4 connectors
- 4 shrink-sheaths for protection of individual wires
- 1 shrink-sheath for protection of the 4-pole wire.

The sheath shrinks with heating (flame or drier) which causes resin outlet granting connection waterproofing.

Permite la conexión de los cables eléctricos sumergidos en el agua.

Et kit comprende:

- 4 conectores
- 4 tubos termorretráctiles para la protección de los conductores individuales
- 1 tubo termorretráctil para la protección del cable cuatripolar.

La retracción del tubo se realiza bajo la acción de una fuente de calor (flama o secador de cabellos) que provoca una salida de resina asegurando la impermeabilidad de la conexión.



Installation examples - Ejemplos de instalación

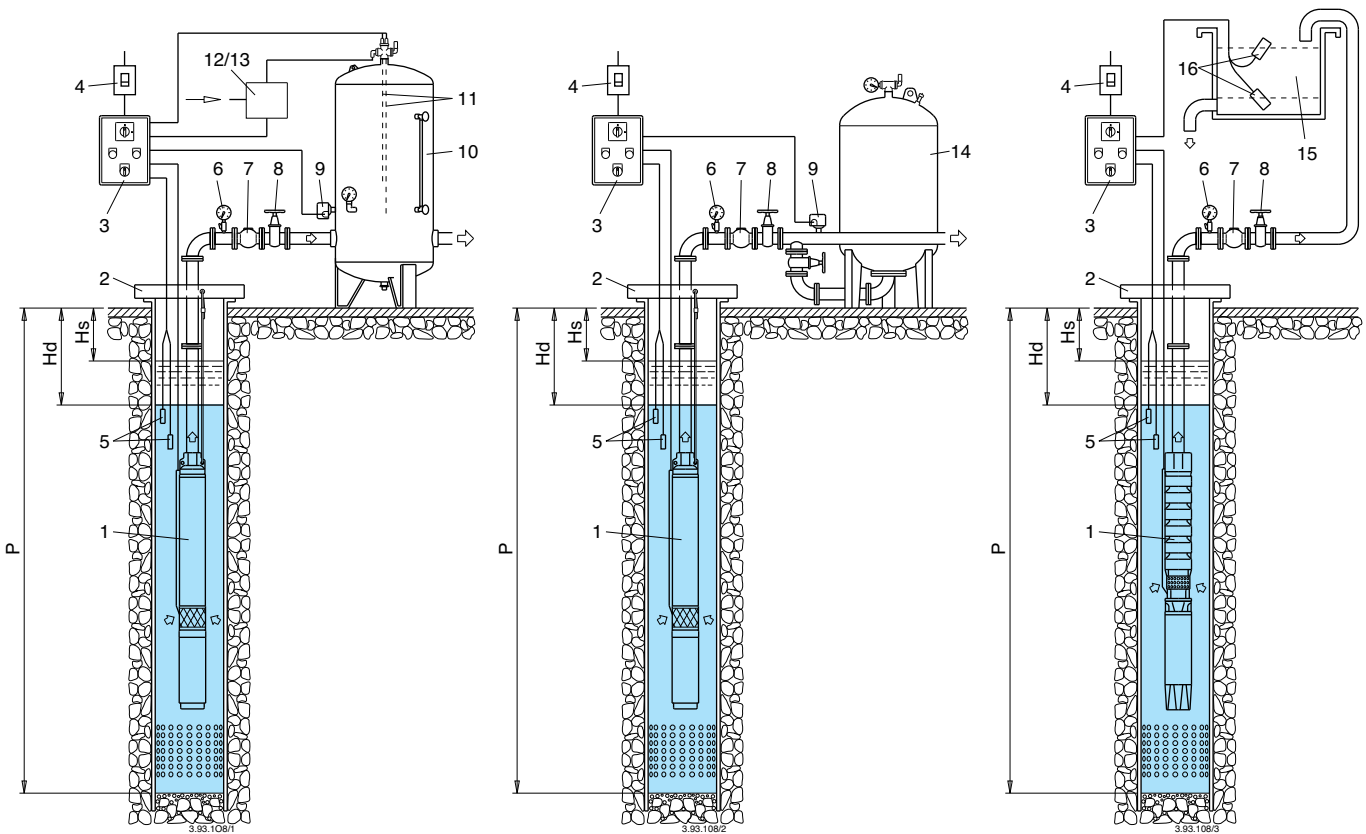

- 1 Submersible pump
- 2 Pump support system
- 3 Electric control board
- 4 Circuit breaker
- 5 Minimum level probes
- 6 Pressure gauge
- 7 Check valve
- 8 Throttle gate valve
- 9 Pressure switch
- 10 Pressure tank
- 11 Probes for air entry control
- 12 Electric valve
- 13 Compressor
- 14 Membrane tank
- 15 Storage tank
- 16 Start-stop probes

Hs Static level
Hd Dynamic level
P Tubewell depth

- 1 Electrobomba sumergible
- 2 Brida de anclaje
- 3 Cuadro eléctrico
- 4 Seccionador de línea
- 5 Sondas de nivel mínimo
- 6 Manómetro
- 7 Válvula de retención
- 8 Válvula reguladora
- 9 Presóstato
- 10 Depósito acumulador de presión
- 11 Sondas control nivel de aire
- 12 Electroválvula
- 13 Electrocompresor
- 14 Acumulador de presión con membrana
- 15 Depósito elevado
- 16 Sondas de arranque y paro

Hs Nivel estático
Hd Nivel dinámico
P Profundidad del pozo