

55. NB**Model B****50/60 Hz****Contents of this chapter**

Kit type	Page
Shaft seal	759
Spacer ring for shaft seal	763
O-ring	764
Shaft	766
Wear ring	779
Impeller	781
Nut, washer and key for impeller	781
Sensor for NBE Series 2000	782

**Shaft seal**

MG13/RMG13

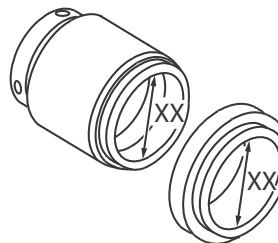

HJ92N / HJ977



M7N

**Fig. 1** Shaft seal designs**Content**

Pos.	Description	BAQE	BAQV	BQQE	BQQV	BBQE	BBQV	DAQF			
105	Shaft seal	1	1	1	1	1	1	1			
Burgmann specification	Type	MG13/ XX-G6	MG13/ XX-G6	MG13/ XX-G6	MG13/ XX-G6	MG13/ XX-G6	MG13/ XX-G6	HJ92N/ XX-00			
	Material	Material code: A, B, C, D, E, F, G, H, I, J, K, M, N, P, S, T, U, W									
		AQ1E GG	AQ1V GG	Q7Q7E GG	Q7Q7V GG	BQ1E GG	BQ1V GG	AQ1V9 GG			
		Material code: L, R									
		AQ1E MM	AQ1V MM	Q1Q1E MM	Q1Q1V MM	BQ1E MM	BQ1V MM	AQ1V9 MM			
Pos.	Description	DQQE	DQQV	DQQX	DQQK	AQQE	AQQX	AQQK	AQQV	AQAE	AQAV
105	Shaft seal	1	1	1	1	1	1	1	1	1	1
Burgmann specification	Type	HJ92N/ XX-00	HJ92N/ XX-00	HJ92N/ XX-00	HJ92N/ XX-00	M7N/ XX-00	M7N/ XX-00	M7N/ XX-00	M7N/ XX-00	M7N/ XX-00	M7N/ XX-00
	Material	Material code: A, B, C, D, E, F, G, H, I, J, K, M, N, P, S, T, U, W									
		Q6Q6E GG	Q6Q6V GG	Q6Q6X4 GG	Q6Q6K23 GG	Q1Q1E GG	Q1Q1X4 GG	Q1Q1K23 GG	Q1Q1V GG	Q1AE GG	Q1AV GG
		Material code: L, R									
		Q6Q6E MM	Q6Q6V MM	Q6Q6X4M M	Q6Q6K23M M	Q1Q1E MM	Q1Q1X4M M	Q1Q1K23 MM	Q1Q1V MM	Q1AE MM	Q1AV MM

Note: XX = 28, 38, 48, 55 or 60. XX is the internal diameter of the shaft seal.

Shaft seal

Material code: A, B, C, D, E, F, G, H, I, J, K, M, N, P, S, T, U, W

The material code can be found in the type designation on the nameplate.

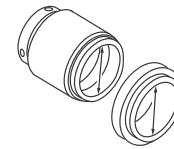

Shaft seal diameter

NB 32 -125 .1 /104 A -F(A) BAQE

Pump type	Shaft seal dia.	BAQE	BAQV	BQQE	BQQV	BQQV ¹⁾	BBQE	BBQV	BQBE	DAQF	
		MG13	MG13	MG13	MG13	MG13	MG13	MG13	RMG13	HJ92N	
32 -	125.1	28	96488302	96548353	98434904	98434905	98670789	96551963	97769885	96548351	96548355
	160.1	28	96488302	96548353	98434904	98434905	98670789	96551963	97769885	96548351	96548355
	200.1	28	96488302	96548353	98434904	98434905	98670789	96551963	97769885	96548351	96548355
	125	28	96488302	96548353	98434904	98434905	98670789	96551963	97769885	96548351	96548355
	160	28	96488302	96548353	98434904	98434905	98670789	96551963	97769885	96548351	96548355
	200	28	96488302	96548353	98434904	98434905	98670789	96551963	97769885	96548351	96548355
40 -	250	28	96488302	96548353	98434904	98434905	98670789	96551963	97769885	96548351	96548355
	125	28	96488302	96548353	98434904	98434905	98670789	96551963	97769885	96548351	96548355
	160	28	96488302	96548353	98434904	98434905	98670789	96551963	97769885	96548351	96548355
	200	28	96488302	96548353	98434904	98434905	98670789	96551963	97769885	96548351	96548355
	250	28	96488302	96548353	98434904	98434905	98670789	96551963	97769885	96548351	96548355
	315	38	96537605	96548357	98434906	98434908	98670790	96551928	97769887	96548356	96548359
50 -	125	28	96488302	96548353	98434904	98434905	98670789	96551963	97769885	96548351	96548355
	160	28	96488302	96548353	98434904	98434905	98670789	96551963	97769885	96548351	96548355
	200	28	96488302	96548353	98434904	98434905	98670789	96551963	97769885	96548351	96548355
	250	28	96488302	96548353	98434904	98434905	98670789	96551963	97769885	96548351	96548355
	315	38	96537605	96548357	98434906	98434908	98670790	96551928	97769887	96548356	96548359
	125	28	96488302	96548353	98434904	98434905	98670789	96551963	97769885	96548351	96548355
65 -	160	28	96488302	96548353	98434904	98434905	98670789	96551963	97769885	96548351	96548355
	200	28	96488302	96548353	98434904	98434905	98670789	96551963	97769885	96548351	96548355
	250	38	96537605	96548357	98434906	98434908	98670790	96551928	97769887	96548356	96548359
	315	38	96537605	96548357	98434906	98434908	98670790	96551928	97769887	96548356	96548359
	160	28	96488302	96548353	98434904	98434905	98670789	96551963	97769885	96548351	96548355
	200	38	96537605	96548357	98434906	98434908	98670790	96551928	97769887	96548356	96548359
80 -	315	38	96537605	96548357	98434906	98434908	98670790	96551928	97769887	96548356	96548359
	315*	48	96306472	96658791	98434909	98434941	98670801	96658794	97769889	-	96658796
	400	48	96306472	96658791	98434909	98434941	98670801	96658794	97769889	-	96658796
	160	28	96488302	96548353	98434904	98434905	98670789	96551963	97769885	96548351	96548355
	200	38	96537605	96548357	98434906	98434908	98670790	96551928	97769887	96548356	96548359
	250	38	96537605	96548357	98434906	98434908	98670790	96551928	97769887	96548356	96548359
100 -	315	38	96537605	96548357	98434906	98434908	98670790	96551928	97769887	96548356	96548359
	315*	48	96306472	96658791	98434909	98434941	98670801	96658794	97769889	-	96658796
	400	48	96306472	96658791	98434909	98434941	98670801	96658794	97769889	-	96658796
	200	38	96537605	96548357	98434906	98434908	98670790	96551928	97769887	96548356	96548359
	250	38	96537605	96548357	98434906	98434908	98670790	96551928	97769887	96548356	96548359
	250*	48	96306472	96658791	98434909	98434941	98670801	96658794	97769889	-	96658796
125 -	315	48	96306472	96658791	98434909	98434941	98670801	96658794	97769889	-	96658796
	400	48	96306472	96658791	98434909	98434941	98670801	96658794	97769889	-	96658796
	400	48	96306472	96658791	98434909	98434941	98670801	96658794	97769889	-	96658796
	500	60	96658812	96658815	98434945	98434947	98670803	96658818	97769893	-	96658820
	200	38	96537605	96548357	98434906	98434908	98670790	96551928	97769887	96548356	96548359
	250	48	96306472	96658791	98434909	98434941	98670801	96658794	97769889	-	96658796
150 -	315.1	48	96306472	96658791	98434909	98434941	98670801	96658794	97769889	-	96658796
	315.2	48	96306472	96658791	98434909	98434941	98670801	96658794	97769889	-	96658796
	315	48	96306472	96658791	98434909	98434941	98670801	96658794	97769889	-	96658796
	400	48	96306472	96658791	98434909	98434941	98670801	96658794	97769889	-	96658796
	400*	55	96306475	96658801	98434943	98434944	98670802	96658804	97769891	-	96658807
	500	60	96658812	96658815	98434945	98434947	98670803	96658818	97769893	-	96658820
200 -	400	55	96306475	96658801	98434943	98434944	98670802	96658804	97769891	-	96658807
	450	55	96306475	96658801	98434943	98434944	98670802	96658804	97769891	-	96658807
	350	55	96306475	96658801	98434943	98434944	98670802	96658804	97769891	-	96658807
	400	55	96306475	96658801	98434943	98434944	98670802	96658804	97769891	-	96658807
	450	60	96658812	96658815	98434945	98434947	98670803	96658818	97769893	-	96658820
	500	60	96658812	96658815	98434945	98434947	98670803	96658818	97769893	-	96658820

Content, see page 758.

* Oversize pump.

1) PWIS-free shaft seal.

Pump type	Shaft seal dia.	DQQE	DQKQ	DQQV	DQXQ	AQQE	AQKQ	AQQV	AQQX	AQAE	AQAV	
		HJ977GN	HJ977GN	HJ977GN	HJ977GN	M7N	M7N	M7N	M7N	M7N	M7N	
32 -	125.1	28	97769895	97769911	97769899	97769907	96551965	97769915	96551967	97769903	96551964	96551966
	160.1	28	97769895	97769911	97769899	97769907	96551965	97769915	96551967	97769903	96551964	96551966
	200.1	28	97769895	97769911	97769899	97769907	96551965	97769915	96551967	97769903	96551964	96551966
	125	28	97769895	97769911	97769899	97769907	96551965	97769915	96551967	97769903	96551964	96551966
	160	28	97769895	97769911	97769899	97769907	96551965	97769915	96551967	97769903	96551964	96551966
	200	28	97769895	97769911	97769899	97769907	96551965	97769915	96551967	97769903	96551964	96551966
	250	28	97769895	97769911	97769899	97769907	96551965	97769915	96551967	97769903	96551964	96551966
40 -	125	28	97769895	97769911	97769899	97769907	96551965	97769915	96551967	97769903	96551964	96551966
	160	28	97769895	97769911	97769899	97769907	96551965	97769915	96551967	97769903	96551964	96551966
	200	28	97769895	97769911	97769899	97769907	96551965	97769915	96551967	97769903	96551964	96551966
	250	28	97769895	97769911	97769899	97769907	96551965	97769915	96551967	97769903	96551964	96551966
	315	38	97769897	97769913	97769901	97769909	96551960	97769917	96551962	97769905	96551929	96551961
50 -	125	28	97769895	97769911	97769899	97769907	96551965	97769915	96551967	97769903	96551964	96551966
	160	28	97769895	97769911	97769899	97769907	96551965	97769915	96551967	97769903	96551964	96551966
	200	28	97769895	97769911	97769899	97769907	96551965	97769915	96551967	97769903	96551964	96551966
	250	28	97769895	97769911	97769899	97769907	96551965	97769915	96551967	97769903	96551964	96551966
	315	38	97769897	97769913	97769901	97769909	96551960	97769917	96551962	97769905	96551929	96551961
65 -	125	28	97769895	97769911	97769899	97769907	96551965	97769915	96551967	97769903	96551964	96551966
	160	28	97769895	97769911	97769899	97769907	96551965	97769915	96551967	97769903	96551964	96551966
	200	28	97769895	97769911	97769899	97769907	96551965	97769915	96551967	97769903	96551964	96551966
	250	38	97769897	97769913	97769901	97769909	96551960	97769917	96551962	97769905	96551929	96551961
	315	38	97769897	97769913	97769901	97769909	96551960	97769917	96551962	97769905	96551929	96551961
80 -	160	28	97769895	97769911	97769899	97769907	96551965	97769915	96551967	97769903	96551964	96551966
	200	38	97769897	97769913	97769901	97769909	96551960	97769917	96551962	97769905	96551929	96551961
	250	38	97769897	97769913	97769901	97769909	96551960	97769917	96551962	97769905	96551929	96551961
	315	38	97769897	97769913	97769901	97769909	96551960	97769917	96551962	97769905	96551929	96551961
	315*	48	97685509	97685516	97685511	97685514	96658799	97685504	96658800	97685501	96658797	96658798
100 -	400	48	97685509	97685516	97685511	97685514	96658799	97685504	96658800	97685501	96658797	96658798
	160	28	97769895	97769911	97769899	97769907	96551965	97769915	96551967	97769903	96551964	96551966
	200	38	97769897	97769913	97769901	97769909	96551960	97769917	96551962	97769905	96551929	96551961
	250	38	97769897	97769913	97769901	97769909	96551960	97769917	96551962	97769905	96551929	96551961
	250*	48	97685509	97685516	97685511	97685514	96658799	97685504	96658800	97685501	96658797	96658798
125 -	315	38	97769897	97769913	97769901	97769909	96551960	97769917	96551962	97769905	96551929	96551961
	315*	48	97685509	97685516	97685511	97685514	96658799	97685504	96658800	97685501	96658797	96658798
	400	48	97685509	97685516	97685511	97685514	96658799	97685504	96658800	97685501	96658797	96658798
	500	60	97685598	97685610	97685602	97685606	96658823	97685590	96658824	97685586	96658821	96658822
	200	38	97769897	97769913	97769901	97769909	96551960	97769917	96551962	97769905	96551929	96551961
150 -	250	48	97685509	97685516	97685511	97685514	96658799	97685504	96658800	97685501	96658797	96658798
	315.1	48	97685509	97685516	97685511	97685514	96658799	97685504	96658800	97685501	96658797	96658798
	315.2	48	97685509	97685516	97685511	97685514	96658799	97685504	96658800	97685501	96658797	96658798
	315	48	97685509	97685516	97685511	97685514	96658799	97685504	96658800	97685501	96658797	96658798
	400	48	97685509	97685516	97685511	97685514	96658799	97685504	96658800	97685501	96658797	96658798
200 -	400*	55	97685596	97685604	97685600	97685608	96658810	97685588	96658811	97685584	96658808	96658809
	500	60	97685598	97685610	97685602	97685606	96658823	97685590	96658824	97685586	96658821	96658822
	400	55	97685596	97685604	97685600	97685608	96658810	97685588	96658811	97685584	96658808	96658809
	450	55	97685596	97685604	97685600	97685608	96658810	97685588	96658811	97685584	96658808	96658809
	350	55	97685596	97685604	97685600	97685608	96658810	97685588	96658811	97685584	96658808	96658809
250 -	400	55	97685596	97685604	97685600	97685608	96658810	97685588	96658811	97685584	96658808	96658809
	450	60	97685598	97685610	97685602	97685606	96658823	97685590	96658824	97685586	96658821	96658822
	500	60	97685598	97685610	97685602	97685606	96658823	97685590	96658824	97685586	96658821	96658822

Content, see page 758.

* Oversize pump.

Shaft seal

Material code: L, R

The material code can be found in the type designation on the nameplate.

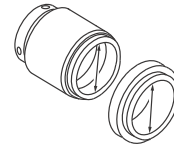

Shaft seal diameter

NB 32-125.1/142 A-F(L)BAQE

Pump type	Shaft seal dia.	BAQE	BAQV	BQQE	BQQV	BQQV ¹⁾	BBQE	BBQV	BQBE	GQQE	GQQV	DAQF	
		MG13	MG13	MG13	MG13	MG13	MG13	MG13	RMG13	MG13S	MG13S	HJ92N	
32 -	125.1	28	96658825	96658827	96658826	96658828	98670804	96658829	97769886	96658830	-	-	96658831
	160.1	28	96658825	96658827	96658826	96658828	98670804	96658829	97769886	96658830	-	-	96658831
	200.1	28	96658825	96658827	96658826	96658828	98670804	96658829	97769886	96658830	-	-	96658831
	125	28	96658825	96658827	96658826	96658828	98670804	96658829	97769886	96658830	-	-	96658831
	160	28	96658825	96658827	96658826	96658828	98670804	96658829	97769886	96658830	-	-	96658831
40 -	200	28	96658825	96658827	96658826	96658828	98670804	96658829	97769886	96658830	-	-	96658831
	250	28	96658825	96658827	96658826	96658828	98670804	96658829	97769886	96658830	-	-	96658831
	125	28	96658825	96658827	96658826	96658828	98670804	96658829	97769886	96658830	-	-	96658831
	160	28	96658825	96658827	96658826	96658828	98670804	96658829	97769886	96658830	-	-	96658831
	200	28	96658825	96658827	96658826	96658828	98670804	96658829	97769886	96658830	-	-	96658831
50 -	315	38	96658836	96658838	96658837	96658839	98670805	96658850	97769888	96658851	-	-	96658852
	125	28	96658825	96658827	96658826	96658828	98670804	96658829	97769886	96658830	-	-	96658831
	160	28	96658825	96658827	96658826	96658828	98670804	96658829	97769886	96658830	-	-	96658831
	200	28	96658825	96658827	96658826	96658828	98670804	96658829	97769886	96658830	-	-	96658831
	250	28	96658825	96658827	96658826	96658828	98670804	96658829	97769886	96658830	-	-	96658831
65 -	315	38	96658836	96658838	96658837	96658839	98670805	96658850	97769888	96658851	-	-	96658852
	125	28	96658825	96658827	96658826	96658828	98670804	96658829	97769886	96658830	-	-	96658831
	160	28	96658825	96658827	96658826	96658828	98670804	96658829	97769886	96658830	-	-	96658831
	200	28	96658825	96658827	96658826	96658828	98670804	96658829	97769886	96658830	-	-	96658831
	250	28	96658825	96658827	96658826	96658828	98670804	96658829	97769886	96658830	-	-	96658831
80 -	315	38	96658836	96658838	96658837	96658839	98670805	96658850	97769888	96658851	-	-	96658852
	160	28	96658825	96658827	96658826	96658828	98670804	96658829	97769886	96658830	-	-	96658831
	200	38	96658836	96658838	96658837	96658839	98670805	96658850	97769888	96658851	-	-	96658852
	250	38	96658836	96658838	96658837	96658839	98670805	96658850	97769888	96658851	-	-	96658852
	315*	48	96658857	96658860	96658858	96658861	98670806	96658862	97769890	-	-	-	96658863
100 -	400	48	96658857	96658860	96658858	96658861	98670806	96658862	97769890	-	-	-	96658863
	160	28	96658825	96658827	96658826	96658828	98670804	96658829	97769886	96658830	-	-	96658831
	200	38	96658836	96658838	96658837	96658839	98670805	96658850	97769888	96658851	-	-	96658852
	250	38	96658836	96658838	96658837	96658839	98670805	96658850	97769888	96658851	-	-	96658852
	250*	48	96658857	96658860	96658858	96658861	98670806	96658862	97769890	-	-	-	96658863
125 -	315	38	96658836	96658838	96658837	96658839	98670805	96658850	97769888	96658851	-	-	96658852
	400	48	96658857	96658860	96658858	96658861	98670806	96658862	97769890	-	-	-	96658863
	500	60	97769920	97769922	97769928	97769930	98670808	97769932	97769894	-	-	-	97536595
	200	38	96658836	96658838	96658837	96658839	98670805	96658850	97769888	96658851	-	-	96658852
	250	48	96658857	96658860	96658858	96658861	98670806	96658862	97769890	-	-	-	96658863
150 -	315.1	48	96658857	96658860	96658858	96658861	98670806	96658862	97769890	-	-	-	96658863
	315.2	48	96658857	96658860	96658858	96658861	98670806	96658862	97769890	-	-	-	96658863
	315	48	96658857	96658860	96658858	96658861	98670806	96658862	97769890	-	-	-	96658863
	400	48	96658857	96658860	96658858	96658861	98670806	96658862	97769890	-	-	-	96658863
	400*	55	97769919	97769921	97769927	97769929	98670807	97769931	97769892	-	-	-	97536552
200 -	500	60	97769920	97769922	97769928	97769930	98670808	97769932	97769894	-	-	-	97536595
	400	55	-	-	-	-	-	-	-	-	-	-	-
	450	55	-	-	-	-	-	-	-	-	-	-	-
	350	55	-	-	-	-	-	-	-	-	-	-	-
	400	55	-	-	-	-	-	-	-	-	-	-	-
250 -	450	60	-	-	-	-	-	-	-	-	-	-	-
	500	60	-	-	-	-	-	-	-	-	-	-	-

Content, see page 758.

* Oversize pump.

1) PWIS-free shaft seal.

Pump type	Shaft seal dia.	DQQE	DQKQ	DQVQ	DQXQ	AQQE	AQKQ	AQVQ	AQXQ	AQAE	AQAV	
		HJ977GN	HJ977GN	HJ977GN	HJ977GN	M7N	M7N	M7N	M7N	M7N	M7N	
32 -	125.1	28	97769896	97769912	97769900	97769908	96658834	97769916	96658835	97769904	96658832	96658833
	160.1	28	97769896	97769912	97769900	97769908	96658834	97769916	96658835	97769904	96658832	96658833
	200.1	28	97769896	97769912	97769900	97769908	96658834	97769916	96658835	97769904	96658832	96658833
	125	28	97769896	97769912	97769900	97769908	96658834	97769916	96658835	97769904	96658832	96658833
	160	28	97769896	97769912	97769900	97769908	96658834	97769916	96658835	97769904	96658832	96658833
	200	28	97769896	97769912	97769900	97769908	96658834	97769916	96658835	97769904	96658832	96658833
40 -	250	28	97769896	97769912	97769900	97769908	96658834	97769916	96658835	97769904	96658832	96658833
	125	28	97769896	97769912	97769900	97769908	96658834	97769916	96658835	97769904	96658832	96658833
	160	28	97769896	97769912	97769900	97769908	96658834	97769916	96658835	97769904	96658832	96658833
	200	28	97769896	97769912	97769900	97769908	96658834	97769916	96658835	97769904	96658832	96658833
	250	28	97769896	97769912	97769900	97769908	96658834	97769916	96658835	97769904	96658832	96658833
	315	38	97769898	97769914	97769902	97769910	96658855	97769918	96658856	97769906	96658853	96658854
50 -	125	28	97769896	97769912	97769900	97769908	96658834	97769916	96658835	97769904	96658832	96658833
	160	28	97769896	97769912	97769900	97769908	96658834	97769916	96658835	97769904	96658832	96658833
	200	28	97769896	97769912	97769900	97769908	96658834	97769916	96658835	97769904	96658832	96658833
	250	28	97769896	97769912	97769900	97769908	96658834	97769916	96658835	97769904	96658832	96658833
	315	38	97769898	97769914	97769902	97769910	96658855	97769918	96658856	97769906	96658853	96658854
	125	28	97769896	97769912	97769900	97769908	96658834	97769916	96658835	97769904	96658832	96658833
65 -	160	28	97769896	97769912	97769900	97769908	96658834	97769916	96658835	97769904	96658832	96658833
	200	28	97769896	97769912	97769900	97769908	96658834	97769916	96658835	97769904	96658832	96658833
	250	38	97769898	97769914	97769902	97769910	96658855	97769918	96658856	97769906	96658853	96658854
	315	38	97769898	97769914	97769902	97769910	96658855	97769918	96658856	97769906	96658853	96658854
	160	28	97769896	97769912	97769900	97769908	96658834	97769916	96658835	97769904	96658832	96658833
	200	38	97769898	97769914	97769902	97769910	96658855	97769918	96658856	97769906	96658853	96658854
80 -	250	38	97769898	97769914	97769902	97769910	96658855	97769918	96658856	97769906	96658853	96658854
	315	38	97769898	97769914	97769902	97769910	96658855	97769918	96658856	97769906	96658853	96658854
	315*	48	97685510	97685518	97685513	97685515	96658866	97685505	96658867	97685502	96658864	96658865
	400	48	97685510	97685518	97685513	97685515	96658866	97685505	96658867	97685502	96658864	96658865
	160	28	97769896	97769912	97769900	97769908	96658834	97769916	96658835	97769904	96658832	96658833
	200	38	97769898	97769914	97769902	97769910	96658855	97769918	96658856	97769906	96658853	96658854
100 -	250	38	97769898	97769914	97769902	97769910	96658855	97769918	96658856	97769906	96658853	96658854
	250*	48	97685510	97685518	97685513	97685515	96658866	97685505	96658867	97685502	96658864	96658865
	315	38	97769898	97769914	97769902	97769910	96658855	97769918	96658856	97769906	96658853	96658854
	315*	48	97685510	97685518	97685513	97685515	96658866	97685505	96658867	97685502	96658864	96658865
	400	48	97685510	97685518	97685513	97685515	96658866	97685505	96658867	97685502	96658864	96658865
	200	38	97769898	97769914	97769902	97769910	96658855	97769918	96658856	97769906	96658853	96658854
125 -	250	38	97769898	97769914	97769902	97769910	96658855	97769918	96658856	97769906	96658853	96658854
	250*	48	97685510	97685518	97685513	97685515	96658866	97685505	96658867	97685502	96658864	96658865
	315	48	97685510	97685518	97685513	97685515	96658866	97685505	96658867	97685502	96658864	96658865
	400	48	97685510	97685518	97685513	97685515	96658866	97685505	96658867	97685502	96658864	96658865
	500	60	97685599	97685611	97685603	97685607	97536585	97685591	97536586	97685587	97769924	97769926
	200	38	97769898	97769914	97769902	97769910	96658855	97769918	96658856	97769906	96658853	96658854
150 -	250	48	97685510	97685518	97685513	97685515	96658866	97685505	96658867	97685502	96658864	96658865
	315.1	48	97685510	97685518	97685513	97685515	96658866	97685505	96658867	97685502	96658864	96658865
	315.2	48	97685510	97685518	97685513	97685515	96658866	97685505	96658867	97685502	96658864	96658865
	315	48	97685510	97685518	97685513	97685515	96658866	97685505	96658867	97685502	96658864	96658865
	400	48	97685510	97685518	97685513	97685515	96658866	97685505	96658867	97685502	96658864	96658865
	400*	55	97685597	97685609	97685601	97685605	97536543	97685589	97536544	97685585	97769923	97769925
200 -	500	60	97685599	97685611	97685603	97685607	97536585	97685591	97536586	97685587	97769924	97769926
	400	55	-	-	-	-	-	-	-	-	-	-
250 -	450	55	-	-	-	-	-	-	-	-	-	-
	350	55	-	-	-	-	-	-	-	-	-	-
	400	55	-	-	-	-	-	-	-	-	-	-
	450	60	-	-	-	-	-	-	-	-	-	-
500	60	-	-	-	-	-	-	-	-	-	-	

Content, see page 758.

* Oversize pump.

Spacer ring for shaft seal

(pos. 105b and 105c)

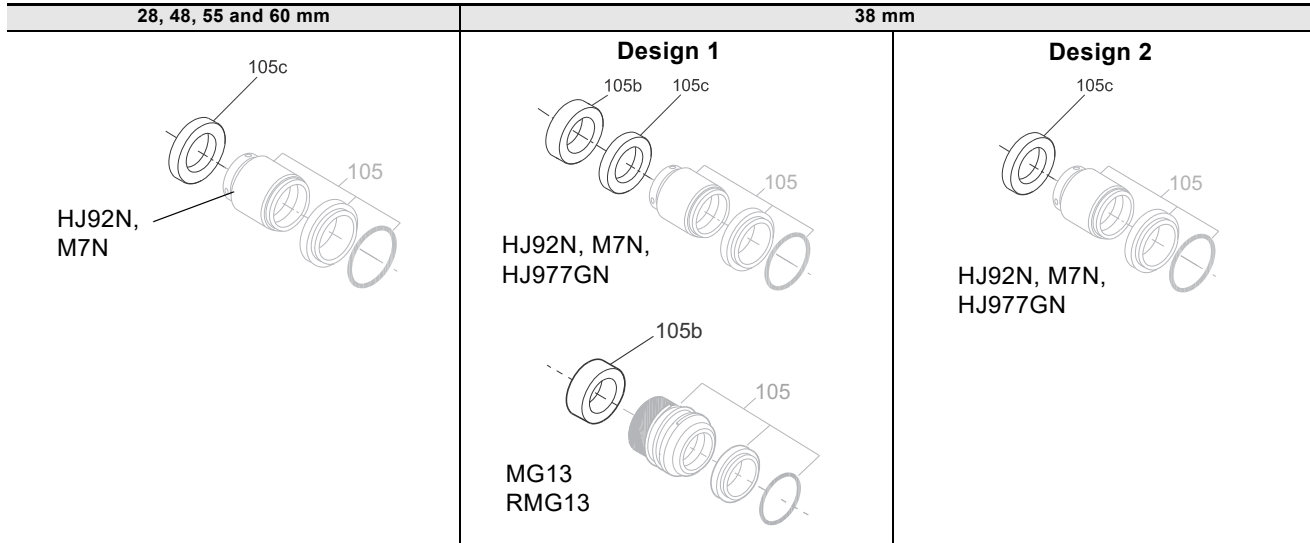

Spacer ring

Pos.	Shaft seal diameter [mm]	Description	Length [mm]	Material code	
				A, B, C, D, E, F, G, H, K, M, N, P, S	I, J, L, R, T, U, W
105b	38	Spacer ring	15.5	96591277	96938601
	28		7.5	96938597	96938598
	38		10	96938599	96938600
105c	48		15	96938602	96938603
	55		22.5	96938604	96938605
	60		17.5	96938606	96938607
	38		15.5	96930797	96930799
105b and 105c	38		10		

38 mm spacer ring			
Pump type	Shaft seal dia.	Design	
32 -	125.1	28	-
	160.1	28	-
	200.1	28	-
	125	28	-
40 -	160	28	-
	200	28	-
	250	28	-
	125	28	-
50 -	160	28	-
	200	28	-
	250	28	-
	315	38	2
65 -	125	28	-
	160	28	-
	200	28	-
	250	38	1
80 -	315	38	1
	160	28	-
	200	38	1
	250	38	1
100 -	315	38/48	1
	400	48	-
	160	28	-
	200	38	1
125 -	250	38/48	1
	315	38/48	1
	400	48	-

38 mm spacer ring			
Pump type	Shaft seal dia.	Design	
125 -	200	38	-
	250	38/48	1
	315	48	-
	400	48	-
	500	60	-
150 -	200	38	1
	250	48	-
	315.1	48	-
	315.2	48	-
	315	48	-
200 -	400	48/55	-
	500	60	-
	400	55	-
	450	55	-
250 -	350	55	-
	400	55	-
	450	60	-
500	60	-	

O-ring

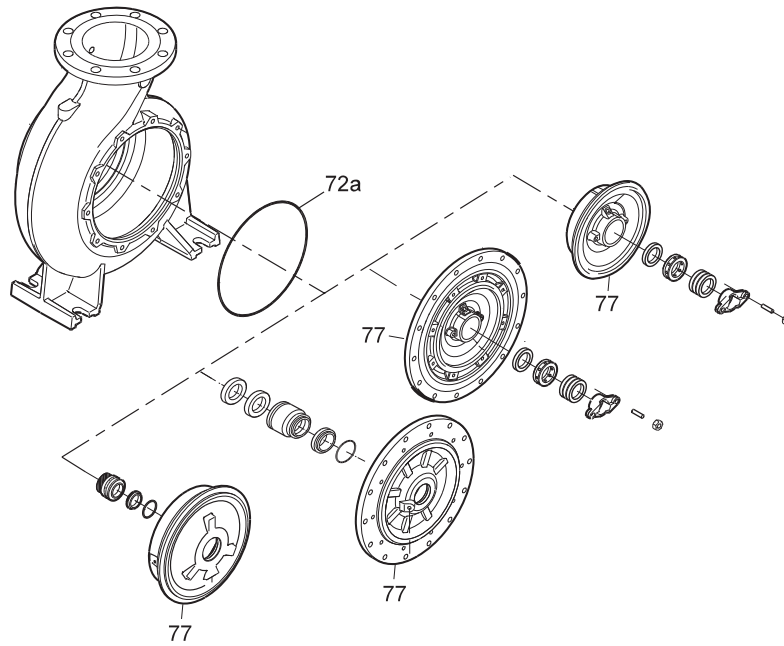

TM04 7046 1410

O-ring	
Pos.	Content
72a	1 x O-ring

NK 32-125.1/142 A1-F-L-BAQE

The O-ring materials can be found in the type designation on the nameplate.

Code	Material
E	EPDM
M	FEPS
K	FFKM
V	FKM
F	FXM
X	HNBR

Pump type	Shaft seal dia.	O-ring kit 1 (Pos. 72a)					
		E (EPDM)	M (FEPS)	K (FFKM)	V (FKM)	F (FXM)	X (HNBR)
125.1	28	97757659	97904673	97904674	97757697	97790022	97904675
160.1	28	97757659	97904673	97904674	97757697	97790022	97904675
200.1	28	97757671	97904679	97904691	97757698	97790080	97904692
32 -	125	97757659	97904673	97904674	97757697	97790022	97904675
	160	97757659	97904673	97904674	97757697	97790022	97904675
	200	97757671	97904679	97904691	97757698	97790080	97904692
	250	97757672	97904676	97904677	97757699	97790081	97904678
40 -	125	97757659	97904673	97904674	97757697	97790022	97904675
	160	97757659	97904673	97904674	97757697	97790022	97904675
	200	97757671	97904679	97904691	97757698	97790080	97904692
	250	97757672	97904676	97904677	97757699	97790081	97904678
	315	97757675	96887770	96887761	97757705	96887764	96887767
50 -	125	97757659	97904673	97904674	97757697	97790022	97904675
	160	97757659	97904673	97904674	97757697	97790022	97904675
	200	97757671	97904679	97904691	97757698	97790080	97904692
	250	97757672	97904676	97904677	97757699	97790081	97904678
	315	97757675	96887770	96887761	97757705	96887764	96887767
65 -	125	97757659	97904673	97904674	97757697	97790022	97904675
	160	97757659	97904673	97904674	97757697	97790022	97904675
	200	97757671	97904679	97904691	97757698	97790080	97904692
	250	97757673	96887769	96887760	97757703	96887763	96887766
	315	97757675	96887770	96887761	97757705	96887764	96887767
80 -	160	97757659	97904673	97904674	97757697	97790022	97904675
	200	97757671	97904679	97904691	97757698	97790080	97904692
	250	97757673	96887769	96887760	97757703	96887763	96887766
	315	97757675	96887770	96887761	97757705	96887764	96887767
	315*	97757675	96887770	96887761	97757705	96887764	96887767
	400	97757676	96887771	96887762	97757707	96887765	96887768
100 -	160	97757659	97904673	97904674	97757697	97790022	97904675
	200	97757671	97904679	97904691	97757698	97790080	97904692
	250	97757673	96887769	96887760	97757703	96887763	96887766
	250*	97757673	96887769	96887760	97757703	96887763	96887766
	315	97757675	96887770	96887761	97757705	96887764	96887767
	315*	97757675	96887770	96887761	97757705	96887764	96887767
	400	97757676	96887771	96887762	97757707	96887765	96887768
125 -	200	97757671	97904679	97904691	97757698	97790080	97904692
	250	97757673	96887769	96887760	97757703	96887763	96887766
	250*	97757673	96887769	96887760	97757703	96887763	96887766
	315	97757675	96887770	96887761	97757705	96887764	96887767
	400	97757676	96887771	96887762	97757707	96887765	96887768
	500	97757679	97536641	97536606	97757712	97536608	97536609
150 -	200	97757671	97904679	97904691	97757698	97790080	97904692
	250	97757673	96887769	96887760	97757703	96887763	96887766
	315.1	97757675	96887770	96887761	97757705	96887764	96887767
	315.2	97757675	96887770	96887761	97757705	96887764	96887767
	315	97757675	96887770	96887761	97757705	96887764	96887767
	400	97757676	96887771	96887762	97757707	96887765	96887768
	400*	97757676	96887771	96887762	97757707	96887765	96887768
	500	97757679	97536641	97536606	97757712	97536608	97536609
200 -	400	97757676	-	-	97757707	96887765	-
	450	97757677	-	-	97757708	97790102	-
250 -	350	97757676	-	-	97757707	96887765	-
	400	97757676	-	-	97757707	96887765	-
	450	97757677	-	-	97757708	97790102	-
	500	97757679	-	-	97757712	97536608	-

* Oversize pump.

Shaft

Stub shaft

67: 1 x nut
66a: 1 x spring washer
66: 1 x washer
11: 1 x key
9: 2 x fixing screws
51: 1 x shaft (stub shaft)

TM04 4732 1909

Pump shaft

67: 1 x nut
66a: 1 x spring washer
66: 1 x washer
11: 1 x key
23: 6/8 x screws
51: 1 x shaft (split shaft)

TM04 4733 1909

Motor bush

9: 2/3 x fixing screw
23: 6/8 x screws
8a: 1 x motor bush



TM04 4734 1909

The material code can be found in the type designation on the nameplate.

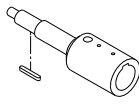
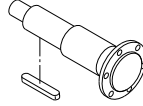
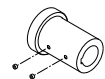

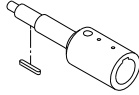
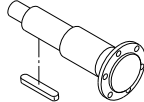
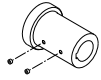
NB 32 -125 .1 /104 A -F-A BBAQE

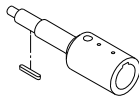
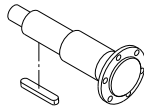
Pump type	Poles	Power [kW]		Frame size	Make	Motor	Stub shaft	Split shaft			Motor bush
		50 Hz 60 Hz									
		Material code							A, B, C, D, E, F, G, H, S	A, B, C, D, E, F, G, H, S	K, M, N, P
32	125	2	1.1	-	90S	All	96039351	-	96847108	96847110	96810018
32	125	2	1.5	1.5	90S	All	96039351	-	96847108	96847110	96810018
32	125	2	2.2	2.2	90L	All	96039351	-	96847108	96847110	96810018
32	125	2	3.0	3.0	100L	All	96039352	-	96847108	96847110	96810019
32	125	2	-	4.0	112M	All	96039352	-	96847108	96847110	96810019
32	125	2	-	5.5	132S	All	96039353	-	96847108	96847110	96810020
32	125	4	0.25	0.25	71A	All	96039349	-	96847108	96847110	96810016
32	125	4	0.37	0.37	71B	All	96039349	-	96847108	96847110	96810016
32	125	4	-	0.55	80A	All	96039350	-	96847108	96847110	96810017
32	125	4	-	0.75	80B	All	96039350	-	96847108	96847110	96810017
32	160	2	2.2	-	90L	All	96039351	-	96847108	96847110	96810018
32	160	2	3.0	3.0	100L	All	96039352	-	96847108	96847110	96810019
32	160	2	4.0	4.0	112M	All	96039352	-	96847108	96847110	96810019
32	160	2	5.5	5.5	132S	All	96039353	-	96847108	96847110	96810020
32	160	2	-	7.5	132S	All	96039353	-	96847108	96847110	96810020
32	160	2	-	11	160M	All	96039354	-	96847108	96847110	96810021
32	160	4	0.25	-	71A	All	96039349	-	96847108	96847110	96810016
32	160	4	0.37	0.37	71B	All	96039349	-	96847108	96847110	96810016
32	160	4	0.55	0.55	80A	All	96039350	-	96847108	96847110	96810017
32	160	4	0.75	0.75	80B	All	96039350	-	96847108	96847110	96810017
32	160	4	-	1.1	90S	All	96039351	-	96847108	96847110	96810018
32	200	2	4.0	-	112M	All	96039352	-	96847108	96847110	96810019
32	200	2	5.5	5.5	132S	All	96039353	-	96847108	96847110	96810020
32	200	2	7.5	7.5	132S	All	96039353	-	96847108	96847110	96810020
32	200	2	-	15	160M	All	96039354	-	96847108	96847110	96810021
32	200	2	-	18.5	160L	All	96039354	-	96847108	96847110	96810021
32	200	2	11.0	11	160M	All	96039354	-	96847108	96847110	96810021
32	200	4	0.55	-	80A	All	96039350	-	96847108	96847110	96810017
32	200	4	0.75	0.75	80B	All	96039350	-	96847108	96847110	96810017
32	200	4	1.1	1.1	90S	All	96039351	-	96847108	96847110	96810018
32	200	4	1.5	1.5	90L	All	96039351	-	96847108	96847110	96810018
32	200	4	-	2.2	100L	All	96039352	-	96847108	96847110	96810019
32	250	2	5.5	5.5	132S	All	-	96847108	96847108	96847110	96810020
32	250	2	7.5	7.5	132S	All	-	96847108	96847108	96847110	96810020
32	250	2	-	18.5	160L	All	-	96847108	96847108	96847110	96810021
32	250	2	11.0	11	160M	All	-	96847108	96847108	96847110	96810021
32	250	2	15.0	15	160M	All	-	96847108	96847108	96847110	96810021
32	250	4	0.75	-	80B	All	-	96847108	96847108	96847110	96810017
32	250	4	1.1	1.1	90S	All	-	96847108	96847108	96847110	96810018
32	250	4	1.5	1.5	90L	All	-	96847108	96847108	96847110	96810018
32	250	4	2.2	2.2	100L	All	-	96847108	96847108	96847110	96810019
32	125.1	2	0.75	-	80A	All	96039350	-	96847108	96847110	96810017

Pump type	Motor				Stub shaft	Split shaft			Motor bush		
	Poles	Power [kW]	Frame size	Make							
	50 Hz		60 Hz		Material code						
		A, B, C, D, E, F, G, H, S	A, B, C, D, E, F, G, H, S	K, M, N, P	I, J, L, R, T, U, W						
32	125.1	2	1.1	1.1	90S	All	96039351	-	96847108	96847110	96810018
32	125.1	2	1.5	1.5	90S	All	96039351	-	96847108	96847110	96810018
32	125.1	2	2.2	2.2	90L	All	96039351	-	96847108	96847110	96810018
32	125.1	2	-	3.0	100L	All	96039352	-	96847108	96847110	96810019
32	125.1	2	-	4.0	112M	All	96039352	-	96847108	96847110	96810019
32	125.1	4	0.25	0.25	71A	All	96039349	-	96847108	96847110	96810016
32	125.1	4	0.37	0.37	71B	All	96039349	-	96847108	96847110	96810016
32	125.1	4	-	0.55	80A	All	96039350	-	96847108	96847110	96810017
32	160.1	2	1.5	-	90S	All	96039351	-	96847108	96847110	96810018
32	160.1	2	2.2	2.2	90L	All	96039352	-	96847108	96847110	96810018
32	160.1	2	3.0	3.0	100L	All	96039352	-	96847108	96847110	96810019
32	160.1	2	4.0	4.0	112M	All	96039352	-	96847108	96847110	96810019
32	160.1	2	-	5.5	132S	All	96039353	-	96847108	96847110	96810020
32	160.1	2	-	7.5	132S	All	96039353	-	96847108	96847110	96810020
32	160.1	4	0.25	-	71A	All	96039349	-	96847108	96847110	96810016
32	160.1	4	0.37	0.37	71B	All	96039349	-	96847108	96847110	96810016
32	160.1	4	0.55	0.55	80A	All	96039350	-	96847108	96847110	96810017
32	160.1	4	-	0.75	80B	All	96039350	-	96847108	96847110	96810017
32	200.1	2	3.0	-	100L	All	96039352	-	96847108	96847110	96810019
32	200.1	2	4.0	4.0	112M	All	96039352	-	96847108	96847110	96810019
32	200.1	2	5.5	5.5	132S	All	96039353	-	96847108	96847110	96810020
32	200.1	2	7.5	7.5	132S	All	96039353	-	96847108	96847110	96810020
32	200.1	2	-	11	160M	All	96039354	-	96847108	96847110	96810021
32	200.1	4	0.37	-	71B	All	-	96847108	96847108	96847110	96810016
32	200.1	4	0.55	0.55	80A	All	96039350	-	96847108	96847110	96810017
32	200.1	4	0.75	0.75	80B	All	96039350	-	96847108	96847110	96810017
32	200.1	4	-	1.1	90S	All	96039351	-	96847108	96847110	96810018
32	200.1	4	-	1.5	90L	All	96039351	-	96847108	96847110	96810018
40	125	2	1.5	-	90S	All	96039351	-	96847108	96847110	96810018
40	125	2	2.2	-	90L	All	96039351	-	96847108	96847110	96810018
40	125	2	3.0	3.0	100L	All	96039352	-	96847108	96847110	96810019
40	125	2	4.0	4.0	112M	All	96039352	-	96847108	96847110	96810019
40	125	2	5.5	5.5	132S	All	96039353	-	96847108	96847110	96810020
40	125	2	-	7.5	132S	All	96039353	-	96847108	96847110	96810020
40	125	2	-	11	160M	All	96039354	-	96847108	96847110	96810021
40	125	4	0.25	-	71A	All	96039349	-	96847108	96847110	96810016
40	125	4	0.37	0.37	71B	All	96039349	-	96847108	96847110	96810016
40	125	4	0.55	0.55	80A	All	96039350	-	96847108	96847110	96810017
40	125	4	-	0.75	80B	All	96039350	-	96847108	96847110	96810017
40	125	4	-	1.1	90S	All	96039351	-	96847108	96847110	96810018
40	125	4	-	1.5	90L	All	96039351	-	96847108	96847110	96810018
40	160	2	4.0	-	112M	All	96039352	-	96847108	96847110	96810019
40	160	2	5.5	5.5	132S	All	96039353	-	96847108	96847110	96810020
40	160	2	7.5	7.5	132S	All	96039353	-	96847108	96847110	96810020
40	160	2	11.0	11	160M	All	96039354	-	96847108	96847110	96810021
40	160	2	-	15	160M	All	96039354	-	96847108	96847110	96810021
40	160	4	0.37	-	71B	All	96039349	-	96847108	96847110	96810016
40	160	4	0.55	0.55	80A	All	96039350	-	96847108	96847110	96810017
40	160	4	0.75	0.75	80B	All	96039350	-	96847108	96847110	96810017
40	160	4	1.1	1.1	90S	All	96039351	-	96847108	96847110	96810018
40	160	4	-	1.5	90L	All	96039351	-	96847108	96847110	96810018
40	160	4	-	2.2	100L	All	96039352	-	96847108	96847110	96810019
40	200	2	5.5	-	132S	All	96039353	-	96847108	96847110	96810020
40	200	2	7.5	-	132S	All	96039353	-	96847108	96847110	96810020
40	200	2	11.0	11	160M	All	96039354	-	96847108	96847110	96810021
40	200	2	15.0	15	160M	All	96039354	-	96847108	96847110	96810021
40	200	2	-	18.5	160L	All	96039354	-	96847108	96847110	96810021
40	200	2	-	22	180M	All	96039355	-	96847108	96847110	96306481
40	200	2	-	30	200L	All	96039356	-	96847108	96847110	96306482
40	200	4	0.75	-	80B	All	96039350	-	96847108	96847110	96810017
40	200	4	1.1	1.1	90S	All	96039351	-	96847108	96847110	96810018
40	200	4	1.5	1.5	90L	All	96039351	-	96847108	96847110	96810018
40	200	4	2.2	2.2	100L	All	96039352	-	96847108	96847110	96810019
40	200	4	-	3.0	100L	All	96039352	-	96847108	96847110	96810019

Pump type	Motor				Stub shaft	Split shaft			Motor bush		
	Poles	Power [kW]	Frame size	Make							
					Material code						
		50 Hz	60 Hz			A, B, C, D, E, F, G, H, S	A, B, C, D, E, F, G, H, S	K, M, N, P	I, J, L, R, T, U, W		
40	250	2	11.0	-	160M	All	96039354	-	96847108	96847110	96810021
40	250	2	15.0	15	160M	All	96039354	-	96847108	96847110	96810021
40	250	2	18.5	18.5	160L	All	96039354	-	96847108	96847110	96810021
40	250	2	22	22	180M	All	96039355	-	96847108	96847110	96306481
40	250	2	30	30	200L	All	96039356	-	96847108	96847110	96306482
40	250	2	-	37	200L	All	96039356	-	96847108	96847110	96306482
40	250	4	1.5	-	90L	All	96039351	-	96847108	96847110	96810018
40	250	4	2.2	2.2	100L	All	96039352	-	96847108	96847110	96810019
40	250	4	3.0	3.0	100L	All	96039352	-	96847108	96847110	96810019
40	250	4	-	4.0	112M	All	96039352	-	96847108	96847110	96810019
40	250	4	-	5.5	132S	All	96039353	-	96847108	96847110	96810020
40	315	2	22	-	180M	All	96039360	-	96847117	96847118	96306481
40	315	2	30	-	200L	All	96039361	-	96847117	96847118	96306482
40	315	2	37	-	200L	All	96039361	-	96847117	96847118	96306482
40	315	2	45	-	225M	All	96537610	-	96847117	96847118	96810022
40	315	4	3.0	-	100L	All	-	96847117	96847117	96847118	96810019
40	315	4	4.0	-	112M	All	-	96847117	96847117	96847118	96810019
40	315	4	5.5	5.5	132S	All	96039358	-	96847121	96847123	96810020
40	315	4	7.5	7.5	132S	All	96039358	-	96847117	96847118	96810020
40	315	4	-	11	160M	All	96039359	-	96847117	96847118	96810021
50	125	2	3.0	-	100L	All	96039352	-	96847108	96847110	96810019
50	125	2	4.0	4.0	112M	All	96039352	-	96847108	96847110	96810019
50	125	2	5.5	5.5	132S	All	96039353	-	96847108	96847110	96810020
50	125	2	7.5	7.5	132S	All	96039353	-	96847108	96847110	96810020
50	125	2	-	11	160M	All	96039354	-	96847108	96847110	96810021
50	125	2	-	15	160M	All	96039354	-	96847108	96847110	96810021
50	125	4	0.37	-	71B	All	96039349	-	96847108	96847110	96810016
50	125	4	0.55	0.55	80A	All	96039350	-	96847108	96847110	96810017
50	125	4	0.75	0.75	80B	All	96039350	-	96847108	96847110	96810017
50	125	4	1.1	1.1	90S	All	96039351	-	96847108	96847110	96810018
50	125	4	-	1.5	90L	All	96039351	-	96847108	96847110	96810018
50	160	2	5.5	-	132S	All	96039353	-	96847108	96847110	96810020
50	160	2	7.5	7.5	132S	All	96039353	-	96847108	96847110	96810020
50	160	2	11.0	11	160M	All	96039354	-	96847108	96847110	96810021
50	160	2	15.0	15	160M	All	96039354	-	96847108	96847110	96810021
50	160	2	-	18.5	160L	All	96039354	-	96847108	96847110	96810021
50	160	2	-	22	180M	All	-	96847108	96847108	96847110	96306481
50	160	4	0.55	-	80A	All	96039350	-	96847108	96847110	96810017
50	160	4	0.75	-	80B	All	96039350	-	96847108	96847110	96810017
50	160	4	1.1	1.1	90S	All	96039351	-	96847108	96847110	96810018
50	160	4	1.5	1.5	90L	All	96039351	-	96847108	96847110	96810018
50	160	4	2.2	2.2	100L	All	96039352	-	96847108	96847110	96810019
50	160	4	-	3.0	100L	All	96039352	-	96847108	96847110	96810019
50	200	2	11.0	-	160M	All	96039354	-	96847108	96847110	96810021
50	200	2	15.0	15	160M	All	96039354	-	96847108	96847110	96810021
50	200	2	18.5	18.5	160L	All	96039354	-	96847108	96847110	96810021
50	200	2	22	22	180M	All	96039355	-	96847108	96847110	96306481
50	200	2	-	30	200L	All	96039356	-	96847108	96847110	96306482
50	200	2	-	37	200L	All	96039356	-	96847108	96847110	96306482
50	200	4	1.1	-	90S	All	96039351	-	96847108	96847110	96810018
50	200	4	1.5	-	90L	All	96039351	-	96847108	96847110	96810018
50	200	4	2.2	2.2	100L	All	96039352	-	96847108	96847110	96810019
50	200	4	3.0	3.0	100L	All	96039352	-	96847108	96847110	96810019
50	200	4	-	4.0	112M	All	96039352	-	96847108	96847110	96810019
50	200	4	-	5.5	132S	All	96039353	-	96847108	96847110	96810020
50	250	2	15.0	-	160M	All	96039354	-	96847108	96847110	96810021
50	250	2	18.5	-	160L	All	96039354	-	96847108	96847110	96810021
50	250	2	22	-	180M	All	96039355	-	96847108	96847110	96306481
50	250	2	30	30	200L	All	96039356	-	96847108	96847110	96306482
50	250	2	37	37	200L	All	96039356	-	96847108	96847110	96306482
50	250	4	2.2	-	100L	All	96039352	-	96847108	96847110	96810019
50	250	4	3.0	-	100L	All	96039352	-	96847108	96847110	96810019
50	250	4	4.0	4.0	112M	All	96039352	-	96847108	96847110	96810019

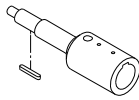
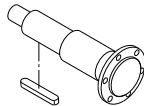

Pump type	Motor				Stub shaft	Split shaft			Motor bush		
	Power [kW]	Frame size	Make	Material code	Material code	Material code	Material code	Material code			
	50 Hz	60 Hz	50 Hz						60 Hz	50 Hz	60 Hz
50	250	4	-	5.5	132S	All	96039353	-	96847108	96847110	96810020
50	250	4	-	7.5	132M	All	96039353	-	96847108	96847110	96810020
50	315	2	30	-	200L	All	96039361	-	96847113	96847114	96306482
50	315	2	37	-	200L	All	96039361	-	96847113	96847114	96306482
50	315	2	45	-	225M	All	96537610	-	96847117	96847118	96810022
50	315	2	55	-	250M	All	-	96847121	96847121	96847123	96306483
50	315	4	4.0	-	112M	All	-	96847117	96847117	96847118	96810019
50	315	4	5.5	5.5	132S	All	96039358	-	96847117	96847118	96810020
50	315	4	7.5	7.5	132M	All	96039358	-	96847117	96847118	96810020
50	315	4	11.0	11	160M	All	96039359	-	96847117	96847118	96810021
50	315	4	-	15	160L	All	96039359	-	96847117	96847118	96810021
65	125	2	4.0	-	112M	All	96039352	-	96847108	96847110	96810019
65	125	2	5.5	-	132S	All	96039353	-	96847108	96847110	96810020
65	125	2	7.5	7.5	132S	All	96039353	-	96847108	96847110	96810020
65	125	2	11.0	11	160M	All	96039354	-	96847108	96847110	96810021
65	125	2	-	15	160M	All	96039354	-	96847108	96847110	96810021
65	125	2	-	18.5	160L	All	96039354	-	96847108	96847110	96810021
65	125	4	0.55	-	80A	All	96039350	-	96847108	96847110	96810017
65	125	4	0.75	-	80B	All	96039350	-	96847108	96847110	96810017
65	125	4	1.1	1.1	90S	All	96039351	-	96847108	96847110	96810018
65	125	4	-	1.5	90L	All	96039351	-	96847108	96847110	96810018
65	125	4	-	2.2	100L	All	96039352	-	96847108	96847110	96810019
65	160	2	7.5	-	132S	All	-	96847108	96847108	96847110	96810020
65	160	2	11.0	11	160M	All	96039354	-	96847108	96847110	96810021
65	160	2	15.0	15	160M	All	96039354	-	96847108	96847110	96810021
65	160	2	18.5	18.5	160L	All	96039354	-	96847108	96847110	96810021
65	160	2	-	22	180M	All	96039355	-	96847108	96847110	96306481
65	160	2	-	30	200L	All	96039356	-	96847108	96847110	96306482
65	160	4	0.75	-	80B	All	-	96847108	96847108	96847110	96810017
65	160	4	1.1	-	90S	All	96039351	-	96847108	96847110	96810018
65	160	4	1.5	1.5	90L	All	96039351	-	96847108	96847110	96810018
65	160	4	2.2	2.2	100L	All	96039352	-	96847108	96847110	96810019
65	160	4	-	3.0	100L	All	96039352	-	96847108	96847110	96810019
65	160	4	-	4.0	112M	All	96039352	-	96847108	96847110	96810019
65	200	2	11.0	-	160M	All	96039354	-	96847108	96847110	96810021
65	200	2	15.0	-	160M	All	96039354	-	96847108	96847110	96810021
65	200	2	18.5	18.5	160L	All	96039354	-	96847108	96847110	96810021
65	200	2	22	22	180M	All	96039355	-	96847108	96847110	96306481
65	200	2	30	30	200L	All	96039356	-	96847108	96847110	96306482
65	200	2	37	37	200L	All	96039356	-	96847108	96847110	96306482
65	200	4	1.5	-	90L	All	-	96847108	96847108	96847110	96810018
65	200	4	2.2	-	100L	All	96039352	-	96847108	96847110	96810019
65	200	4	3.0	3.0	100L	All	96039352	-	96847108	96847110	96810019
65	200	4	4.0	4.0	112M	All	96039352	-	96847108	96847110	96810019
65	200	4	-	5.5	132S	All	96039353	-	96847108	96847110	96810020
65	200	4	-	7.5	132M	All	96039353	-	96847108	96847110	96810020
65	250	2	30	-	200L	All	96039361	-	96847117	96847118	96306482
65	250	2	37	-	200L	All	96039361	-	96847117	96847118	96306482
65	250	2	45	45	225M	All	96537610	-	96847117	96847118	96810022
65	250	2	55	55	250M	All	-	96847121	96847121	96847123	96306483
65	250	2	75	75	280S	All	-	96847121	96847121	96847123	96306484
65	250	2	-	90	280M	All	-	96847121	96847121	96847123	96306484
65	250	2	-	110	315S	All	-	96847121	96847121	96847123	96306484
65	250	4	3.0	-	100L	All	96039357	-	96847117	96847118	96810019
65	250	4	4.0	-	112M	All	96039357	-	96847117	96847118	96810019
65	250	4	5.5	5.5	132S	All	96039358	-	96847117	96847118	96810020
65	250	4	7.5	7.5	132M	All	96039358	-	96847117	96847118	96810020
65	250	4	-	11	160M	All	96039359	-	96847117	96847118	96810021
65	250	4	-	15	160L	All	96039359	-	96847117	96847118	96810021
65	315	2	55	-	250M	All	-	96847121	96847121	96847123	96306483
65	315	2	75	-	280S	All	-	96847121	96847121	96847123	96306484
65	315	2	90	-	280M	All	-	96847121	96847121	96847123	96306484
65	315	2	110	-	315S	All	-	96847121	96847121	96847123	96306484

Pump type	Motor				Stub shaft	Split shaft			Motor bush		
	Poles	Power [kW]		Frame size	Make						
		50 Hz	60 Hz						Material code		
			A, B, C, D, E, F, G, H, S	A, B, C, D, E, F, G, H, S	K, M, N, P	I, J, L, R, T, U, W					
65	315	4	5.5	-	132S	All	96039358	-	96847117	96847118	96810020
65	315	4	7.5	7.5	132M	All	96039358	-	96847117	96847118	96810020
65	315	4	-	18.5	180M	All	96039360	-	96847117	96847118	96306481
65	315	4	-	22	180L	All	96039360	-	96847117	96847118	96306481
65	315	4	11.0	11	160M	All	96039359	-	96847117	96847118	96810021
65	315	4	15.0	15	160L	All	96039359	-	96847117	96847118	96810021
80	160	2	11.0	-	160M	All	96039354	-	96847108	96847110	96810021
80	160	2	15.0	-	160M	All	96039354	-	96847108	96847110	96810021
80	160	2	18.5	-	160L	All	96039354	-	96847108	96847110	96810021
80	160	2	22	22	180M	All	96039355	-	96847108	96847110	96306481
80	160	2	30	30	200L	All	96039356	-	96847108	96847110	96306482
80	160	2	-	37	200L	All	96039356	-	96847108	96847110	96306482
80	160	4	1.5	-	90L	All	96039351	-	96847108	96847110	96810018
80	160	4	2.2	-	100L	All	96039352	-	96847108	96847110	96810019
80	160	4	3.0	3.0	100L	All	96039352	-	96847108	96847110	96810019
80	160	4	4.0	4.0	112M	All	96039352	-	96847108	96847110	96810019
80	160	4	-	5.5	132S	All	-	96847108	96847108	96847110	96810020
80	200	2	22	-	180M	All	96039360	-	96847117	96847118	96306481
80	200	2	30	-	200L	All	96039361	-	96847117	96847118	96306482
80	200	2	37	37	200L	All	96039361	-	96847117	96847118	96306482
80	200	2	45	45	225M	All	96537610	-	96847117	96847118	96810022
80	200	2	55	55	250M	All	-	96847121	96847121	96847123	96306483
80	200	2	-	75	280S	All	-	96847121	96847121	96847123	96306484
80	200	2	-	90	280M	All	-	96847121	96847121	96847123	96306484
80	200	4	2.2	-	100L	All	-	96847117	96847117	96847118	96810019
80	200	4	3.0	-	100L	All	-	96847117	96847117	96847118	96810019
80	200	4	4.0	4.0	112M	All	-	96847117	96847117	96847118	96810019
80	200	4	5.5	5.5	132S	All	96039358	-	96847117	96847118	96810020
80	200	4	7.5	7.5	132M	All	96039358	-	96847117	96847118	96810020
80	200	4	-	11	160M	All	96039359	-	96847117	96847118	96810021
80	250	2	45	-	225M	All	96537610	-	96847117	96847118	96810022
80	250	2	55	-	250M	All	-	96847121	96847121	96847123	96306483
80	250	2	75	75	280S	All	-	96847121	96847121	96847123	96306484
80	250	2	90	90	280M	All	-	96847121	96847121	96847123	96306484
80	250	2	-	110	315S	All	-	96847121	96847121	96847123	96306484
80	250	2	-	132	315M	All	-	96847121	96847121	96847123	96306484
80	250	2	-	160	315L	All	-	96847121	96847121	96847123	96306484
80	250	4	5.5	-	132S	All	96039358	-	96847117	96847118	96810020
80	250	4	7.5	7.5	132M	All	96039358	-	96847117	96847118	96810020
80	250	4	11.0	11	160M	All	96039359	-	96847117	96847118	96810021
80	250	4	-	15	160L	All	96039359	-	96847117	96847118	96810021
80	250	4	-	18.5	180M	All	96039360	-	96847117	96847118	96306481
80	315	2	90	-	280M	All	-	96847121	96847121	96847123	96306484
80	315	2	110	-	315S	All	-	96847121	96847121	96847123	96306484
80	315	2	132	-	315M	All	-	96847121	96847121	96847123	96306484
80	315	4	18.5	18.5	180M	All	96039360	-	96847117	96847118	96306481
80	315	4	22	22	180L	All	96039360	-	96847117	96847118	96306481
80	315	4	-	30	200L	All	96039361	-	96847117	96847118	96306482
80	315	4	-	37	225S	All	96537609	-	96847121	96847123	96306483
80	315	4	-	45	225M	All	96537609	-	96847121	96847123	96306483
80	315	4	11.0	-	160M	All	96039359	-	96847117	96847118	96810021
80	315	4	15.0	-	160L	All	96039359	-	96847117	96847118	96810021
80	400	4	18.5	-	180M	All	-	96306478	96306478	96847124	96306481
80	400	4	22	-	180L	All	-	96306478	96306478	96847124	96306481
80	400	4	30	30	200L	All	-	96306478	96306478	96847124	96306482
80	400	4	37	37	225S	All	-	96306479	96306479	96847125	96306483
80	400	4	45	45	225M	All	-	96306479	96306479	96847125	96306483
80	400	4	-	55	250M	Siemens, MMG-E	-	96306479	96306479	96847125	96306484
80	400	4	-	55	250SC	MMG-G, EFF1 & EFF2	-	96306479	96306479	96847125	96810023
80	400	4	-	75	280S	Siemens, MMG-E	-	96306479	96306479	96847125	96306485
80	400	4	-	75	250MC	MMG-G, EFF1 & EFF2	-	96306479	96306479	96847125	96810023
80	400	4	-	90	280M	Siemens, MMG-E	-	96306479	96306479	96847125	96306485
80	400	4	-	90	280S	MMG-G, EFF1 & EFF2	-	96306479	96306479	96847125	96306486

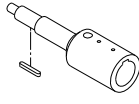
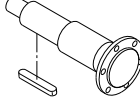
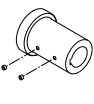

Pump type	Motor				Stub shaft	Split shaft			Motor bush		
	Power [kW]	Frame size	Make	Material code	A, B, C, D, E, F, G, H, S	A, B, C, D, E, F, G, H, S	K, M, N, P	I, J, L, R, T, U, W			
	50 Hz	60 Hz	Poles								
80	315 *	2	160	-	315L	All	-	96306479	96306479	96847125	96306484
100	160	2	22	-	180M	All	-	96847108	96847108	96847110	96306481
100	160	2	30	-	200L	All	-	96847108	96847108	96847110	96306482
100	160	2	37	37	200L	All	-	96847108	96847108	96847110	96306482
100	160	4	2.2	-	100L	All	-	96847108	96847108	96847110	96810019
100	160	4	3.0	-	100L	All	-	96847108	96847108	96847110	96810019
100	160	4	4.0	4.0	112M	All	-	96847108	96847108	96847110	96810019
100	160	4	-	5.5	132S	All	-	96847108	96847108	96847110	96810020
100	160	4	-	7.5	132M	All	-	96847108	96847108	96847110	96810020
100	160	6	0.55	-	80B	All	-	96847108	96847108	96847110	96810017
100	160	6	0.75	-	90S	All	-	96847108	96847108	96847110	96810018
100	160	6	1.1	1.1	90L	All	-	96847108	96847108	96847110	96810018
100	160	6	-	1.5	100L	All	-	96847108	96847108	96847110	96810019
100	160	6	-	2.2	112M	All	-	96847108	96847108	96847110	96810019
100	200	2	30	-	200L	All	96039361	-	96847113	96847114	96306482
100	200	2	37	-	200L	All	96039361	-	96847113	96847114	96306482
100	200	2	45	-	225M	All	96537610	-	96847117	96847118	96810022
100	200	2	55	55	250M	All	-	96847121	96847121	96847123	96306483
100	200	2	75	75	280S	All	-	96847121	96847121	96847123	96306484
100	200	2	-	90	280M	All	-	96847121	96847121	96847123	96306484
100	200	2	-	110	315S	All	-	96847121	96847121	96847123	96306484
100	200	2	-	132	315M	All	-	96847121	96847121	96847123	96306484
100	200	4	4.0	-	112M	All	-	96847117	96847117	96847118	96810019
100	200	4	5.5	5.5	132S	All	96039358	-	96847117	96847118	96810020
100	200	4	7.5	7.5	132M	All	96039358	-	96847117	96847118	96810020
100	200	4	11.0	11	160M	All	96039359	-	96847117	96847118	96810021
100	200	4	-	15	160L	All	96039359	-	96847117	96847118	96810021
100	200	4	-	18.5	180M	All	96039360	-	96847117	96847118	96306481
100	200	6	1.1	-	90L	All	-	96847117	96847117	96847118	96810018
100	200	6	1.5	1.5	100L	All	-	96847117	96847117	96847118	96810019
100	200	6	2.2	2.2	112M	All	-	96847117	96847117	96847118	96810019
100	200	6	3.0	3.0	132SA	All	96039358	-	96847117	96847118	96810020
100	200	6	-	4.0	132MA	All	96039358	-	96847117	96847118	96810020
100	200	6	-	5.5	132MB	All	96039358	-	96847117	96847118	96810020
100	250	2	55	-	250M	All	-	96847121	96847121	96847123	96306483
100	250	2	75	-	280S	All	-	96306479	96306479	96847125	96306484
100	250	2	90	-	280M	All	-	96306479	96306479	96847125	96306484
100	250	2	110	110	315S	All	-	96306479	96306479	96847125	96306484
100	250	2	132	132	315M	All	-	96306479	96306479	96847125	96306484
100	250	2	-	160	315L	All	-	96306479	96306479	96847125	96306484
100	250	4	7.5	-	132M	All	96039358	-	96847117	96847118	96810020
100	250	4	11.0	-	160M	All	96039359	-	96847117	96847118	96810021
100	250	4	15.0	15	160L	All	96039359	-	96847117	96847118	96810021
100	250	4	18.5	18.5	180M	All	96039360	-	96847117	96847118	96306481
100	250	4	-	22	180L	All	96039360	-	96847117	96847118	96306481
100	250	4	-	30	200L	All	96039361	-	96847113	96847114	96306482
100	250	6	2.2	-	112M	All	-	96847117	96847117	96847118	96810019
100	250	6	3.0	-	132SA	All	96039358	-	96847117	96847118	96810020
100	250	6	4.0	4.0	132MA	All	96039358	-	96847117	96847118	96810020
100	250	6	5.5	5.5	132MB	All	96039358	-	96847117	96847118	96810020
100	250	6	-	7.5	160M	All	96039359	-	96847117	96847118	96810021
100	250	6	-	11	160L	All	96039359	-	96847117	96847118	96810021
100	315	2	110	-	315S	All	-	96847121	96847121	96847123	96306484
100	315	2	132	-	315M	All	-	96847121	96847121	96847123	96306484
100	315	4	15.0	-	160L	All	96039359	-	96847117	96847118	96810021
100	315	4	18.5	-	180M	All	96039360	-	96847117	96847118	96306481
100	315	4	22	22	180L	All	96039360	-	96847117	96847118	96306481
100	315	4	30	30	200L	All	96039361	-	96847113	96847114	96306482
100	315	4	-	37	225S	All	96537609	-	96847121	96847123	96306483
100	315	4	-	45	225M	All	96537609	-	96847121	96847123	96306483
100	315	4	-	55	250M	Siemens, MMG-E	-	96847121	96847121	96847123	96306484
100	315	4	-	55	250SC	MMG-G, EFF1 & EFF2	-	96847121	96847121	96847123	96810023
100	315	6	4.0	-	132MA	All	96039358	-	96847117	96847118	96810020

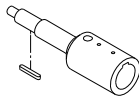
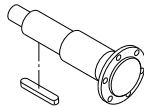

Pump type	Motor							Stub shaft		Split shaft			Motor bush					
	Poles	Power [kW]		Frame size	Make	Material code	Material code	Material code	Material code	Material code	Material code							
												50 Hz 60 Hz		A, B, C, D, E, F, G, H, S	A, B, C, D, E, F, G, H, S	K, M, N, P	I, J, L, R, T, U, W	
100	315	6	5.5	-	132MB	All	96039358	-	96847117	96847118	96810020							
100	315	6	7.5	7.5	160M	All	96039359	-	96847117	96847118	96810021							
100	315	6	11.0	11	160L	All	96039359	-	96847117	96847118	96810021							
100	315	6	-	15	180L	All	96039360	-	96847117	96847118	96306481							
100	400	4	22	-	180L	All	-	96306478	96306478	96847124	96306481							
100	400	4	30	-	200L	All	-	96306478	96306478	96847124	96306482							
100	400	4	37	37	225S	All	-	96306479	96306479	96847125	96306483							
100	400	4	45	45	225M	All	-	96306479	96306479	96847125	96306483							
100	400	4	55	55	250M	Siemens, MMG-E	-	96306479	96306479	96847125	96306484							
100	400	4	55	55	250SC	MMG-G, EFF1 & EFF2	-	96306479	96306479	96847125	96810023							
100	400	4	-	75	280S	Siemens, MMG-E	-	96306479	96306479	96847125	96306485							
100	400	4	-	75	250MC	MMG-G, EFF1 & EFF2	-	96306479	96306479	96847125	96810023							
100	400	4	-	90	280M	Siemens, MMG-E	-	96306479	96306479	96847125	96306485							
100	400	4	-	90	280S	MMG-G, EFF1 & EFF2	-	96306479	96306479	96847125	96306486							
100	400	6	7.5	-	160M	All	-	96306478	96306478	96847124	96810021							
100	400	6	11.0	11	160L	All	-	96306478	96306478	96847124	96810021							
100	400	6	15.0	15	180L	All	-	96306478	96306478	96847124	96306481							
100	400	6	18.5	18.5	200LA	All	-	96306478	96306478	96847124	96306482							
100	400	6	-	22	200LB	All	-	96306478	96306478	96847124	96306482							
100	400	6	-	30	225M	All	-	96306479	96306479	96847125	96306483							
100	250 *	2	-	200	315L	All	-	96306479	96306479	96847125	96306484							
100	315 *	2	160	-	315L	All	-	96306479	96306479	96847125	96306484							
100	315 *	2	200	-	315L	All	-	96306479	96306479	96847125	96306484							
125	200	2	45	-	225M	All	96537610	-	96847117	96847118	96810022							
125	200	2	55	-	250M	All	-	96847121	96847121	96847123	96306483							
125	200	2	75	75	280S	All	-	96847121	96847121	96847123	96306484							
125	200	2	90	90	280M	All	-	96847121	96847121	96847123	96306484							
125	200	2	110	110	315S	All	-	96847121	96847121	96847123	96306484							
125	200	2	-	132	315M	All	-	96847121	96847121	96847123	96306484							
125	200	2	-	160	315L	All	-	96847121	96847121	96847123	96306484							
125	200	2	-	200	315L	All	-	96847121	96847121	96847123	96306484							
125	200	4	5.5	-	132S	All	96039358	-	96847117	96847118	96810020							
125	200	4	7.5	-	132M	All	96039358	-	96847117	96847118	96810020							
125	200	4	11.0	11	160M	All	96039359	-	96847117	96847118	96810021							
125	200	4	15.0	15	160L	All	96039359	-	96847117	96847118	96810021							
125	200	4	-	18.5	180M	All	96039360	-	96847117	96847118	96306481							
125	200	4	-	22	180L	All	96039360	-	96847117	96847118	96306481							
125	200	6	1.5	-	100L	All	-	96847117	96847117	96847118	96810019							
125	200	6	2.2	-	112M	All	-	96847117	96847117	96847118	96810019							
125	200	6	3.0	3.0	132SA	All	96039358	-	96847117	96847118	96810020							
125	200	6	4.0	4.0	132MA	All	96039358	-	96847117	96847118	96810020							
125	200	6	-	5.5	132MB	All	96039358	-	96847117	96847118	96810020							
125	200	6	-	7.5	160M	All	96039359	-	96847117	96847118	96810021							
125	250	4	18.5	18.5	180M	All	96039360	-	96847117	96847118	96306481							
125	250	4	22	22	180L	All	96039360	-	96847117	96847118	96306481							
125	250	4	30	30	200L	All	96039361	-	96847113	96847114	96306482							
125	250	4	-	37	225S	All	96537609	-	96847121	96847123	96306483							
125	250	4	-	45	225M	All	96537609	-	96847121	96847123	96306483							
125	250	4	11.0	-	160M	All	96039359	-	96847117	96847118	96810021							
125	250	4	15.0	-	160L	All	96039359	-	96847117	96847118	96810021							
125	250	6	3.0	-	132SA	All	96039358	-	96847117	96847118	96810020							
125	250	6	4.0	-	132MA	All	96039358	-	96847117	96847118	96810020							
125	250	6	5.5	5.5	132MB	All	96039358	-	96847117	96847118	96810020							
125	250	6	7.5	7.5	160M	All	96039359	-	96847117	96847118	96810021							
125	250	6	-	11	160L	All	96039359	-	96847117	96847118	96810021							
125	250	6	-	15	180L	All	96039360	-	96847117	96847118	96306481							
125	315	2	132	-	315M	All	-	96306479	96306479	96847125	96306484							
125	315	2	160	-	315L	All	-	96306479	96306479	96847125	96306484							
125	315	2	200	-	315L	All	-	96306479	96306479	96847125	96306484							
125	315	4	18.5	-	180M	All	-	96306478	96306478	96847124	96306481							
125	315	4	22	-	180L	All	-	96306478	96306478	96847124	96306481							
125	315	4	30	30	200L	All	-	96306478	96306478	96847124	96306482							
125	315	4	37	37	225S	All	-	96306479	96306479	96847125	96306483							

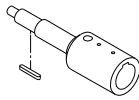
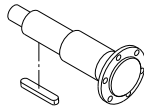
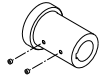
Pump type	Motor				Stub shaft	Split shaft			Motor bush		
	Poles	Power [kW]	Frame size	Make							
	50 Hz		60 Hz				Material code				
		A, B, C, D, E, F, G, H, S	A, B, C, D, E, F, G, H, S	K, M, N, P	I, J, L, R, T, U, W						
125	315	4	45	45	225M	All	-	96306479	96306479	96847125	96306483
125	315	4	-	55	250M	Siemens, MMG-E	-	96306479	96306479	96847125	96306484
125	315	4	-	55	250SC	MMG-G, EFF1 & EFF2	-	96306479	96306479	96847125	96810023
125	315	4	-	75	280S	Siemens, MMG-E	-	96306479	96306479	96847125	96306485
125	315	4	-	75	250MC	MMG-G, EFF1 & EFF2	-	96306479	96306479	96847125	96810023
125	315	6	5.5	-	132MB	All	-	96306478	96306478	96847124	96810020
125	315	6	7.5	7.5	160M	All	-	96306478	96306478	96847124	96810021
125	315	6	-	18.5	200LA	All	-	96306478	96306478	96847124	96306482
125	315	6	-	22	200LB	All	-	96306478	96306478	96847124	96306482
125	315	6	11.0	11	160L	All	-	96306478	96306478	96847124	96810021
125	315	6	15.0	15	180L	All	-	96306478	96306478	96847124	96306481
125	400	4	37	-	225S	All	-	96306479	96306479	96847125	96306483
125	400	4	45	-	225M	All	-	96306479	96306479	96847125	96306483
125	400	4	55	55	250M	Siemens, MMG-E	-	96306479	96306479	96847125	96306484
125	400	4	55	55	250SC	MMG-G, EFF1 & EFF2	-	96306479	96306479	96847125	96810023
125	400	4	75	75	280S	Siemens, MMG-E	-	96306479	96306479	96847125	96306485
125	400	4	75	75	250MC	MMG-G, EFF1 & EFF2	-	96306479	96306479	96847125	96810023
125	400	4	90	90	280M	Siemens, MMG-E	-	96306479	96306479	96847125	96306485
125	400	4	90	90	280S	MMG-G, EFF1 & EFF2	-	96306479	96306479	96847125	96306486
125	400	4	-	110	315S	Siemens, MMG-E	-	96306479	96306479	96847125	96306486
125	400	4	-	110	280M	MMG-G, EFF1 & EFF2	-	96306479	96306479	96847125	96306486
125	400	4	-	132	315M	Siemens, MMG-E	-	96306479	96306479	96847125	96306486
125	400	4	-	132	315S	MMG-G, EFF1 & EFF2	-	96306479	96306479	96847125	96306487
125	400	6	18.5	18.5	200LA	Siemens	-	96306478	96306478	96847124	96306482
125	400	6	22	22	200LB	Siemens	-	96306478	96306478	96847124	96306482
125	400	6	30	30	225M	Siemens	-	96306479	96306479	96847125	96306483
125	400	6	-	37	250M	Siemens	-	96306479	96306479	96847125	96306484
125	400	6	-	37	250S	MMG-G, EFF1 & EFF2	-	96306479	96306479	96847125	96810023
125	400	6	-	45	280S	Siemens, MMG-E	-	96306479	96306479	96847125	96306485
125	400	6	-	45	250M	MMG-G, EFF1 & EFF2	-	96306479	96306479	96847125	96810023
125	400	6	11.0	-	160L	All	-	96306478	96306478	96847124	96810021
125	400	6	15.0	-	180L	All	-	96306478	96306478	96847124	96306481
125	500	4	55	-	250M	Siemens, MMG-E	-	96847130	96847130	96847131	96306484
125	500	4	55	-	250SC	MMG-G, EFF1 & EFF2	-	96847130	96847130	96847131	96810023
125	500	4	75	-	280S	Siemens, MMG-E	-	96847130	96847130	96847131	96306485
125	500	4	75	-	250MC	MMG-G, EFF1 & EFF2	-	96847130	96847130	96847131	96810023
125	500	4	90	-	280M	Siemens, MMG-E	-	96847130	96847130	96847131	96306485
125	500	4	90	-	280S	MMG-G, EFF1 & EFF2	-	96847130	96847130	96847131	96306486
125	500	4	110	110	315S	Siemens, MMG-E	-	96847130	96847130	96847131	96306486
125	500	4	110	110	280M	MMG-G, EFF1 & EFF2	-	96847130	96847130	96847131	96306486
125	500	4	132	132	315M	Siemens, MMG-E	-	96847130	96847130	96847131	96306486
125	500	4	132	132	315S	MMG-G, EFF1 & EFF2	-	96847130	96847130	96847131	96306487
125	500	4	160	160	315M	Siemens, MMG-E	-	96847130	96847130	96847131	96306486
125	500	4	160	160	315M	MMG-G, EFF1 & EFF2	-	96847130	96847130	96847131	96306487
125	500	4	-	200	315L	Siemens, MMG-E	-	96847130	96847130	96847131	96306486
125	500	4	-	200	315M	MMG-G, EFF1 & EFF2	-	96847130	96847130	96847131	96306487
125	500	6	18.5	-	200LA	Siemens	-	96847128	96847128	96847129	96306482
125	500	6	22	-	200LB	Siemens	-	96847128	96847128	96847129	96306482
125	500	6	30	-	225M	Siemens	-	96847130	96847130	96847131	96306483
125	500	6	37	37	250M	Siemens, MMG-E	-	96847130	96847130	96847131	96306484
125	500	6	37	37	250S	MMG-G, EFF1 & EFF2	-	96847130	96847130	96847131	96810023
125	500	6	45	45	280S	Siemens, MMG-E	-	96847130	96847130	96847131	96306485
125	500	6	45	45	250M	MMG-G, EFF1 & EFF2	-	96847130	96847130	96847131	96810023
125	500	6	55	55	280M	Siemens, MMG-E	-	96847130	96847130	96847131	96306485
125	500	6	55	55	280S	MMG-G, EFF1 & EFF2	-	96847130	96847130	96847131	96306486
125	500	6	-	75	315S	Siemens, MMG-E	-	96847130	96847130	96847131	96306486
125	500	6	-	75	280M	MMG-G, EFF1 & EFF2	-	96847130	96847130	96847131	96306486
125	500	6	-	90	315M	Siemens, MMG-E	-	96847130	96847130	96847131	96306486
125	500	6	-	90	315S	MMG-G, EFF1 & EFF2	-	96847130	96847130	96847131	96306487
125	250*	2	90	-	280M	All	-	96306479	96306479	96847125	96306484
125	250*	2	110	-	315S	All	-	96306479	96306479	96847125	96306484
125	250*	2	132	-	315M	All	-	96306479	96306479	96847125	96306484
125	250*	2	160	160	315L	All	-	96306479	96306479	96847125	96306484

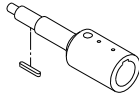
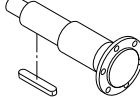
Pump type	Motor				Stub shaft	Split shaft			Motor bush		
	Power [kW]	Frame size	Make	Material code							
	50 Hz	60 Hz	A, B, C, D, E, F, G, H, S					A, B, C, D, E, F, G, H, S	K, M, N, P	I, J, L, R, T, U, W	
125	250*	2	200	200	315L	All	-	96306479	96306479	96847125	96306484
150	200	2	75	-	280S	All	-	96847121	96847121	96847123	96306484
150	200	2	90	-	280M	All	-	96847121	96847121	96847123	96306484
150	200	2	110	110	315S	All	-	96847121	96847121	96847123	96306484
150	200	2	-	132	315M	All	-	96847121	96847121	96847123	96306484
150	200	2	-	160	315L	All	-	96847121	96847121	96847123	96306484
150	200	2	-	200	315L	All	-	96847121	96847121	96847123	96306484
150	200	4	7.5	-	132M	All	96039358	-	96847117	96847118	96810020
150	200	4	11.0	-	160M	All	96039359	-	96847117	96847118	96810021
150	200	4	15.0	15	160L	All	96039359	-	96847117	96847118	96810021
150	200	4	-	18.5	180M	All	96039360	-	96847117	96847118	96306481
150	200	4	-	22	180L	All	96039360	-	96847117	96847118	96306481
150	200	6	2.2	-	112M	All	-	96847117	96847117	96847118	96810019
150	200	6	3.0	-	132SA	All	96039358	-	96847117	96847118	96810020
150	200	6	4.0	4.0	132MA	All	96039358	-	96847117	96847118	96810020
150	200	6	-	5.5	132MB	All	96039358	-	96847117	96847118	96810020
150	200	6	-	7.5	160M	All	96039359	-	96847117	96847118	96810021
150	250	2	132	-	315M	All	-	96306479	96306479	96847125	96306484
150	250	2	160	-	315L	All	-	96306479	96306479	96847125	96306484
150	250	2	200	-	315L	All	-	96306479	96306479	96847125	96306484
150	250	4	18.5	-	180M	All	-	96306478	96306478	96847124	96306481
150	250	4	22	-	180L	All	-	96306478	96306478	96847124	96306481
150	250	4	30	30	200L	All	-	96306478	96306478	96847124	96306482
150	250	4	37	37	225S	All	-	96306479	96306479	96847125	96306483
150	250	4	45	45	225M	All	-	96306479	96306479	96847125	96306483
150	250	4	-	55	250M	Siemens, MMG-E	-	96306479	96306479	96847125	96306484
150	250	4	-	55	250SC	MMG-G, EFF1 & EFF2	-	96306479	96306479	96847125	96810023
150	250	4	-	75	280S	Siemens, MMG-E	-	96306479	96306479	96847125	96306485
150	250	4	-	75	250MC	MMG-G, EFF1 & EFF2	-	96306479	96306479	96847125	96810023
150	250	4	15.0	-	160L	All	-	96306478	96306478	96847124	96810021
150	250	6	5.5	-	132MB	All	-	96306478	96306478	96847124	96810020
150	250	6	7.5	-	160M	All	-	96306478	96306478	96847124	96810021
150	250	6	-	15	180L	All	-	96306478	96306478	96847124	96306481
150	250	6	-	18.5	200LA	All	-	96306478	96306478	96847124	96306482
150	250	6	11.0	11	160L	All	-	96306478	96306478	96847124	96810021
150	315	4	37	-	225S	All	-	96306479	96306479	96847125	96306483
150	315	4	45	-	225M	All	-	96306479	96306479	96847125	96306483
150	315	4	55	55	250M	Siemens, MMG-E	-	96306479	96306479	96847125	96306484
150	315	4	55	55	250SC	MMG-G, EFF1 & EFF2	-	96306479	96306479	96847125	96810023
150	315	4	75	75	280S	Siemens, MMG-E	-	96306479	96306479	96847125	96306485
150	315	4	75	75	250MC	MMG-G, EFF1 & EFF2	-	96306479	96306479	96847125	96810023
150	315	4	90	90	280M	Siemens, MMG-E	-	96306479	96306479	96847125	96306485
150	315	4	90	90	280S	MMG-G, EFF1 & EFF2	-	96306479	96306479	96847125	96306486
150	315	4	-	110	315S	Siemens, MMG-E	-	96306479	96306479	96847125	96306486
150	315	4	-	110	280M	MMG-G, EFF1 & EFF2	-	96306479	96306479	96847125	96306486
150	315	4	-	132	315M	Siemens, MMG-E	-	96306479	96306479	96847125	96306486
150	315	4	-	132	315S	MMG-G, EFF1 & EFF2	-	96306479	96306479	96847125	96306487
150	315	6	11.0	-	160L	All	-	96306478	96306478	96847124	96810021
150	315	6	15.0	-	180L	All	-	96306478	96306478	96847124	96306481
150	315	6	18.5	18.5	200LA	Siemens	-	96306478	96306478	96847124	96306482
150	315	6	22	22	200LB	Siemens	-	96306478	96306478	96847124	96306482
150	315	6	30	30	225M	Siemens	-	96306479	96306479	96847125	96306483
150	315	6	-	37	250M	Siemens	-	96306479	96306479	96847125	96306484
150	315	6	-	37	250S	MMG-G, EFF1 & EFF2	-	96306479	96306479	96847125	96810023
150	315.1	2	200	-	315L	-	-	96306479	96306479	96847125	96306484
150	315.1	2	160	-	315L	-	-	96306479	96306479	96847125	96306484
150	315.1	4	-	75	280S	-	-	96306479	96306479	96847125	96306485
150	315.1	4	-	55	250M	-	-	96306479	96306479	96847125	96306484
150	315.1	4	45	45	225M	-	-	96306479	96306479	96847125	96306483
150	315.1	4	37	37	225S	-	-	96306479	96306479	96847125	96306483
150	315.1	4	30	30	200L	-	-	96306478	96306478	96847124	96306482
150	315.1	4	22	-	180L	-	-	96306478	96306478	96847124	96306481
150	315.1	4	18.5	-	180M	-	-	96306478	96306478	96847124	96306481

Pump type	Motor					Stub shaft	Split shaft			Motor bush
	Poles	Power [kW]	Frame size	Make	Material code					
									50 Hz	60 Hz
150	315.1	6	-	22	200L	-	96306478	96306478	96847124	96306482
150	315.1	6	-	18.5	200L	-	96306478	96306478	96847124	96306482
150	315.1	6	15	15	180L	-	96306478	96306478	96847124	96306481
150	315.1	6	11	11	160L	-	96306478	96306478	96847124	96306481
150	315.1	6	7.5	7.5	160M	-	96306478	96306478	96847124	96810021
150	315.1	6	5.5	-	132M	-	96306478	96306478	96847124	96810020
150	315.2	2	200	-	315L	-	96306479	96306479	96847125	96306484
150	315.2	2	160	-	315L	-	96306479	96306479	96847125	96306484
150	315.2	4	75	75	280S	-	96306479	96306479	96847125	96306485
150	315.2	4	55	55	250M	-	96306479	96306479	96847125	96306484
150	315.2	4	45	45	225M	-	96306479	96306479	96847125	96306483
150	315.2	4	37	37	225S	-	96306479	96306479	96847125	96306483
150	315.2	4	30	-	200L	-	96306478	96306478	96847124	96306482
150	315.2	4	22	-	180L	-	96306478	96306478	96847124	96306481
150	315.2	6	-	22	200L	-	96306478	96306478	96847124	96306482
150	315.2	6	18.5	18.5	200L	-	96306478	96306478	96847124	96306482
150	315.2	6	15	15	180L	-	96306478	96306478	96847124	96306481
150	315.2	6	11	11	160L	-	96306478	96306478	96847124	96306481
150	315.2	6	7.5	-	160M	-	96306478	96306478	96847124	96810021
150	400	4	55	-	250M	Siemens, MMG-E	96306480	96306480	96847127	96306484
150	400	4	55	-	250SC	MMG-G, EFF1 & EFF2	96306480	96306480	96847127	96810023
150	400	4	75	-	280S	Siemens, MMG-E	96306480	96306480	96847127	96306485
150	400	4	75	-	250MC	MMG-G, EFF1 & EFF2	96306480	96306480	96847127	96810023
150	400	4	90	90	280M	Siemens, MMG-E	96306480	96306480	96847127	96306485
150	400	4	90	90	280S	MMG-G, EFF1 & EFF2	96306480	96306480	96847127	96306486
150	400	4	110	110	315S	Siemens, MMG-E	96306480	96306480	96847127	96306486
150	400	4	110	110	280M	MMG-G, EFF1 & EFF2	96306480	96306480	96847127	96306486
150	400	4	132	132	315M	Siemens, MMG-E	96306480	96306480	96847127	96306486
150	400	4	132	132	315S	MMG-G, EFF1 & EFF2	96306480	96306480	96847127	96306487
150	400	4	160	160	315M	Siemens, MMG-E	96306480	96306480	96847127	96306486
150	400	4	160	160	315M	MMG-G, EFF1 & EFF2	96306480	96306480	96847127	96306487
150	400	4	-	200	315L	Siemens, MMG-E	96306480	96306480	96847127	96306486
150	400	4	-	200	315M	MMG-G, EFF1 & EFF2	96306480	96306480	96847127	96306487
150	400	6	18.5	-	200LA	Siemens	96306488	96306488	96847126	96306482
150	400	6	22	22	200LB	Siemens	96306488	96306488	96847126	96306482
150	400	6	30	30	225M	Siemens	96306480	96306480	96847127	96306483
150	400	6	37	37	250M	Siemens, MMG-E	96306480	96306480	96847127	96306484
150	400	6	37	37	250S	MMG-G, EFF1 & EFF2	96306480	96306480	96847127	96810023
150	400	6	45	45	280S	Siemens, MMG-E	96306480	96306480	96847127	96306485
150	400	6	45	45	250M	MMG-G, EFF1 & EFF2	96306480	96306480	96847127	96810023
150	400	6	-	55	280M	Siemens, MMG-E	96306480	96306480	96847127	96306485
150	400	6	-	55	280S	MMG-G, EFF1 & EFF2	96306480	96306480	96847127	96306486
150	400	6	-	75	315S	Siemens, MMG-E	96306480	96306480	96847127	96306486
150	400	6	-	75	280M	MMG-G, EFF1 & EFF2	96306480	96306480	96847127	96306486
150	500	4	132	-	315M	Siemens, MMG-E	96847130	96847130	96847131	96306486
150	500	4	132	-	315S	MMG-G, EFF1 & EFF2	96847130	96847130	96847131	96306487
150	500	4	160	-	315M	Siemens, MMG-E	96847130	96847130	96847131	96306486
150	500	4	160	-	315M	MMG-G, EFF1 & EFF2	96847130	96847130	96847131	96306487
150	500	4	200	-	315L	Siemens, MMG-E	96847130	96847130	96847131	96306486
150	500	4	200	-	315M	MMG-G, EFF1 & EFF2	96847130	96847130	96847131	96306487
150	500	6	37	-	250M	Siemens, MMG-E	96847130	96847130	96847131	96306484
150	500	6	37	-	250S	MMG-G, EFF1 & EFF2	96847130	96847130	96847131	96810023
150	500	6	45	-	280S	Siemens, MMG-E	96847130	96847130	96847131	96306485
150	500	6	45	-	250M	MMG-G, EFF1 & EFF2	96847130	96847130	96847131	96810023
150	500	6	55	55	280M	Siemens, MMG-E	96847130	96847130	96847131	96306485
150	500	6	55	55	280S	MMG-G, EFF1 & EFF2	96847130	96847130	96847131	96306486
150	500	6	75	75	315S	Siemens, MMG-E	96847130	96847130	96847131	96306486
150	500	6	75	75	280M	MMG-G, EFF1 & EFF2	96847130	96847130	96847131	96306486
150	500	6	-	90	315M	Siemens, MMG-E	96847130	96847130	96847131	96306486
150	500	6	-	90	315S	MMG-G, EFF1 & EFF2	96847130	96847130	96847131	96306487
150	500	6	-	110	315	Siemens, MMG-E	96847130	96847130	96847131	96306486
150	500	6	-	110	315M	MMG-G, EFF1 & EFF2	96847130	96847130	96847131	96306487
150	500	6	-	132	315L	MMG-G, EFF1 & EFF2	96847130	96847130	96847131	96306487

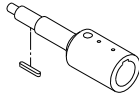
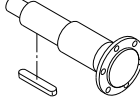
Pump type	Motor				Stub shaft	Split shaft	Motor bush				
	poles	Power [kW]	Frame size	Make							
	50 Hz 60 Hz		Material code								
					A, B, C, D, E, F, G, H, S	A, B, C, D, E, F, G, H, S	K, M, N, P	I, J, L, R, T, U, W			
150	500	6	-	132	315L	MMG-G, EFF1 & EFF2	-	96847130	96847130	96847131	96306487
200	400	4	37	-	225S		-	96306480	-	-	96306483
200	400	4	45	-	225M		-	96306480	-	-	96306483
200	400	4	55	55	250M	Siemens, MMG-E	-	96306480	-	-	96306484
200	400	4	55	55	250SC	MMG-G, EFF1 & EFF2	-	96306480	-	-	96810023
200	400	4	75	75	280S	Siemens, MMG-E	-	96306480	-	-	96306485
200	400	4	75	75	250MC	MMG-G, EFF1 & EFF2	-	96306480	-	-	96810023
200	400	4	90	90	280M	Siemens, MMG-E	-	96306480	-	-	96306485
200	400	4	90	90	280S	MMG-G, EFF1 & EFF2	-	96306480	-	-	96306486
200	400	4	110	110	315S	Siemens, MMG-E	-	96306480	-	-	96306486
200	400	4	110	110	280M	MMG-G, EFF1 & EFF2	-	96306480	-	-	96306487
200	400	4	132	132	315M	Siemens, MMG-E	-	96306480	-	-	96306486
200	400	4	132	132	315S	MMG-G, EFF1 & EFF2	-	96306480	-	-	96306487
200	400	4	-	160	315L	Siemens, MMG-E	-	96306480	-	-	96306486
200	400	4	-	160	315M	MMG-G, EFF1 & EFF2	-	96306480	-	-	96306487
200	400	4	-	200	315L	Siemens, MMG-E	-	96306480	-	-	96306486
200	400	4	-	200	315M	MMG-G, EFF1 & EFF2	-	96306480	-	-	96306487
200	400	6	15	-	180L		-	96306488	-	-	96306481
200	400	6	18.5	-	200L		-	96306488	-	-	96306482
200	400	6	22	22	200L		-	96306488	-	-	96306482
200	400	6	30	30	225M		-	96306480	-	-	96306483
200	400	6	37	37	250M		-	96306480	-	-	96306484
200	400	6	37	37	250S		-	96306480	-	-	96810023
200	400	6	-	45	280S	Siemens, MMG-E	-	96306480	-	-	96306485
200	400	6	-	45	250M	MMG-G, EFF1 & EFF2	-	96306480	-	-	96810023
200	400	6	-	55	280M	Siemens, MMG-E	-	96306480	-	-	96306485
200	400	6	-	55	280S	MMG-G, EFF1 & EFF2	-	96306480	-	-	96306486
200	450	4	75	75	280S	Siemens, MMG-E	-	96306480	-	-	96306485
200	450	4	75	75	250MC	MMG-G, EFF1 & EFF2	-	96306480	-	-	96810023
200	450	4	90	90	280M	Siemens, MMG-E	-	96306480	-	-	96306485
200	450	4	90	90	280S	MMG-G, EFF1 & EFF2	-	96306480	-	-	96306486
200	450	4	110	110	315S	Siemens, MMG-E	-	96306480	-	-	96306486
200	450	4	110	110	280M	MMG-G, EFF1 & EFF2	-	96306480	-	-	96306486
200	450	4	132	132	315M	Siemens, MMG-E	-	96306480	-	-	96306486
200	450	4	132	132	315S	MMG-G, EFF1 & EFF2	-	96306480	-	-	96306487
200	450	4	160	160	315L	Siemens, MMG-E	-	96306480	-	-	96306486
200	450	4	160	160	315M	MMG-G, EFF1 & EFF2	-	96306480	-	-	96306487
200	450	4	-	200	315L	Siemens, MMG-E	-	96306480	-	-	96306486
200	450	4	-	200	315M	MMG-G, EFF1 & EFF2	-	96306480	-	-	96306487
200	450	4	-	288	315L	Siemens	-	96306480	-	-	96306487
200	450	4	-	250	355M	MMG-E	-	96306480	-	-	96810026
200	450	4	-	250	315C	MMG-G, EFF1 & EFF2	-	96306480	-	-	96810026
200	450	6	18.5	-	200L		-	96306488	-	-	96306482
200	450	6	22	-	200L		-	96306488	-	-	96306482
200	450	6	30	-	225M		-	96306480	-	-	96306483
200	450	6	37	37	250M	Siemens, MMG-E	-	96306480	-	-	96306484
200	450	6	37	37	250S	MMG-G, EFF1 & EFF2	-	96306480	-	-	96810023
200	450	6	45	45	280S	Siemens, MMG-E	-	96306480	-	-	96306485
200	450	6	45	45	250M	MMG-G, EFF1 & EFF2	-	96306480	-	-	96810023
200	450	6	-	55	280M	Siemens, MMG-E	-	96306480	-	-	96306485
200	450	6	-	55	280S	MMG-G, EFF1 & EFF2	-	96306480	-	-	96306486
200	450	6	-	75	315S	Siemens, MMG-E	-	96306480	-	-	96306486
200	450	6	-	75	280M	MMG-G, EFF1 & EFF2	-	96306480	-	-	96306486
200	450	6	-	90	315M	Siemens, MMG-E	-	96306480	-	-	96306486
200	450	6	-	90	315S	MMG-G, EFF1 & EFF2	-	96306480	-	-	96306487
250	350	4	37	-	225S		-	96306480	-	-	96306483
250	350	4	45	-	225M		-	96306480	-	-	96306483
250	350	4	55	-	250M		-	96306480	-	-	96306484
250	350	4	55	-	250SC		-	96306480	-	-	96810023
250	350	4	75	75	280S	Siemens, MMG-E	-	96306480	-	-	96306485
250	350	4	75	75	250MC	MMG-G, EFF1 & EFF2	-	96306480	-	-	96810023
250	350	4	90	90	280M	Siemens, MMG-E	-	96306480	-	-	96306485
250	350	4	90	90	280S	MMG-G, EFF1 & EFF2	-	96306480	-	-	96306486

Pump type	Motor					Stub shaft	Split shaft			Motor bush	
	Power [kW]	Frame size	Make								
	50 Hz	60 Hz				Material code					
						A, B, C, D, E, F, G, H, S	A, B, C, D, E, F, G, H, S	K, M, N, P	I, J, L, R, T, U, W		
250	350	4	-	110	315S	Siemens, MMG-E	-	96306480	-	-	96306486
250	350	4	-	110	280M	MMG-G, EFF1 & EFF2	-	96306480	-	-	96306486
250	350	4	-	132	315M	Siemens, MMG-E	-	96306480	-	-	96306486
250	350	4	-	132	315S	MMG-G, EFF1 & EFF2	-	96306480	-	-	96306487
250	350	6	11	-	160L		-	96306488	-	-	96810021
250	350	6	15	-	180L		-	96306488	-	-	96306481
250	350	6	18.5	-	200L		-	96306488	-	-	96306482
250	350	6	22	22	200L		-	96306488	-	-	96306482
250	350	6	-	30	225M		-	96306480	-	-	96306483
250	350	6	-	37	250M	Siemens, MMG-E	-	96306480	-	-	96306484
250	350	6	-	37	250S	MMG-G, EFF1 & EFF2	-	96306480	-	-	96810023
250	350	6	-	45	280S	Siemens, MMG-E	-	96306480	-	-	96306485
250	350	6	-	45	250M	MMG-G, EFF1 & EFF2	-	96306480	-	-	96810023
250	400	4	45	-	225M		-	96306480	-	-	96306483
250	400	4	55	-	250M	Siemens, MMG-E	-	96306480	-	-	96306484
250	400	4	55	-	250SC	MMG-G, EFF1 & EFF2	-	96306480	-	-	96810023
250	400	4	75	75	280S	Siemens, MMG-E	-	96306480	-	-	96306485
250	400	4	75	75	250MC	MMG-G, EFF1 & EFF2	-	96306480	-	-	96810023
250	400	4	90	90	280M	Siemens, MMG-E	-	96306480	-	-	96306485
250	400	4	90	90	280S	MMG-G, EFF1 & EFF2	-	96306480	-	-	96306486
250	400	4	110	110	315S	Siemens, MMG-E	-	96306480	-	-	96306486
250	400	4	110	110	280M	MMG-G, EFF1 & EFF2	-	96306480	-	-	96306486
250	400	4	132	132	315M	Siemens, MMG-E	-	96306480	-	-	96306486
250	400	4	132	132	315S	MMG-G, EFF1 & EFF2	-	96306480	-	-	96306487
250	400	4	160	160	315L	Siemens, MMG-E	-	96306480	-	-	96306486
250	400	4	160	160	315M	MMG-G, EFF1 & EFF2	-	96306480	-	-	96306487
250	400	4	-	200	315L	Siemens, MMG-E	-	96306480	-	-	96306486
250	400	4	-	200	315M	MMG-G, EFF1 & EFF2	-	96306480	-	-	96306487
250	400	4	-	288	315L	Siemens	-	96306480	-	-	96306487
250	400	4	-	250	355M	MMG-E	-	96306480	-	-	96810026
250	400	4	-	250	315C	MMG-G, EFF1 & EFF2	-	96306480	-	-	96810026
250	400	6	15	-	180L		-	96306488	-	-	96306481
250	400	6	18.5	-	200L		-	96306488	-	-	96306482
250	400	6	22	-	200L		-	96306488	-	-	96306482
250	400	6	30	30	225M		-	96306480	-	-	96306483
250	400	6	37	37	250M	Siemens, MMG-E	-	96306480	-	-	96306484
250	400	6	37	37	250S	MMG-G, EFF1 & EFF2	-	96306480	-	-	96810023
250	400	6	45	45	280S	Siemens, MMG-E	-	96306480	-	-	96306485
250	400	6	45	45	250M	MMG-G, EFF1 & EFF2	-	96306480	-	-	96810023
250	400	6	-	55	280M	Siemens, MMG-E	-	96306480	-	-	96306485
250	400	6	-	55	280S	MMG-G, EFF1 & EFF2	-	96306480	-	-	96306486
250	400	6	-	75	315S	Siemens, MMG-E	-	96306480	-	-	96306486
250	400	6	-	75	280M	MMG-G, EFF1 & EFF2	-	96306480	-	-	96306486
250	400	6	-	90	315M	Siemens, MMG-E	-	96306480	-	-	96306486
250	400	6	-	90	315S	MMG-G, EFF1 & EFF2	-	96306480	-	-	96306487
250	450	4	75	-	280S	Siemens, MMG-E	-	96847130	-	-	96306485
250	450	4	75	-	250M	MMG-G, EFF1 & EFF2	-	96847130	-	-	96810023
250	450	4	90	-	280M	Siemens, MMG-E	-	96847130	-	-	96306485
250	450	4	90	-	280S	MMG-G, EFF1 & EFF2	-	96847130	-	-	96306486
250	450	4	110	110	315S	Siemens, MMG-E	-	96847130	-	-	96306486
250	450	4	110	110	280M	MMG-G, EFF1 & EFF2	-	96847130	-	-	96306486
250	450	4	132	132	315M	Siemens, MMG-E	-	96847130	-	-	96306486
250	450	4	132	132	315S	MMG-G, EFF1 & EFF2	-	96847130	-	-	96306487
250	450	4	160	160	315L	Siemens, MMG-E	-	96847130	-	-	96306486
250	450	4	160	160	315M	MMG-G, EFF1 & EFF2	-	96847130	-	-	96306487
250	450	4	200	200	315L	Siemens, MMG-E	-	96847130	-	-	96306486
250	450	4	200	200	315M	MMG-G, EFF1 & EFF2	-	96847130	-	-	96306487
250	450	4	-	288	315L	Siemens	-	96306480	-	-	96306487
250	450	4	-	250	355M	MMG-E	-	96306480	-	-	96810026
250	450	4	-	250	315C	MMG-G, EFF1 & EFF2	-	96306480	-	-	96810026
250	450	4	-	362	315L	Siemens	-	96847130	-	-	96306487
250	450	4	-	315	355L	MMG-E	-	96847130	-	-	96810026
250	450	4	-	315	315D	MMG-G, EFF1 & EFF2	-	96847130	-	-	96810026

Pump type	Motor					Stub shaft	Split shaft	Material code		Motor bush
	Poles	Power [kW]	Frame size	Make						
	50 Hz 60 Hz					A, B, C, D, E, F, G, H, S	A, B, C, D, E, F, G, H, S	K, M, N, P	I, J, L, R, T, U, W	
250	450	6	18.5	-	200L	-	96847130	-	-	96306482
250	450	6	22	-	200L	-	96847130	-	-	96306482
250	450	6	30	-	225M	-	96847130	-	-	96306483
250	450	6	37	37	250M	Siemens, MMG-E	96847130	-	-	96306484
250	450	6	37	37	250S	MMG-G, EFF1 & EFF2	96847130	-	-	96810023
250	450	6	45	45	280S	Siemens, MMG-E	96847130	-	-	96306485
250	450	6	45	45	250M	MMG-G, EFF1 & EFF2	96847130	-	-	96810023
250	450	6	55	55	280M	Siemens, MMG-E	96847130	-	-	96306485
250	450	6	55	55	280S	MMG-G, EFF1 & EFF2	96847130	-	-	96306486
250	450	6	-	75	315S	Siemens, MMG-E	96847130	-	-	96306486
250	450	6	-	75	280M	MMG-G, EFF1 & EFF2	96847130	-	-	96306486
250	450	6	-	90	315M	Siemens, MMG-E	96847130	-	-	96306486
250	450	6	-	90	315S	MMG-G, EFF1 & EFF2	96847130	-	-	96306487
250	450	6	-	110	315L	Siemens, MMG-E	96847130	-	-	96306486
250	450	6	-	110	315M	MMG-G, EFF1 & EFF2	96847130	-	-	96306487
250	500	4	160	-	315L	Siemens, MMG-E	96847130	-	-	96306486
250	500	4	160	-	315M	MMG-G, EFF1 & EFF2	96847130	-	-	96306487
250	500	4	200	-	315L	Siemens, MMG-E	96847130	-	-	96306486
250	500	4	200	-	315M	MMG-G, EFF1 & EFF2	96847130	-	-	96306487
250	500	4	-	288	315	Siemens	96847130	-	-	96306487
250	500	4	-	250	355M	MMG-E	96847130	-	-	96810026
250	500	4	-	250	315C	MMG-G, EFF1 & EFF2	96847130	-	-	96810026
250	500	4	-	362	315	Siemens	96847130	-	-	96306487
250	500	4	-	315	355L	MMG-E	96847130	-	-	96810026
250	500	4	-	408	355	Siemens	96847130	-	-	96810026
250	500	4	-	460	355	Siemens	96847130	-	-	96810026
250	500	6	45	-	280S	Siemens, MMG-E	96847130	-	-	96306485
250	500	6	45	-	250M	MMG-G, EFF1 & EFF2	96847130	-	-	96810023
250	500	6	55	-	280M	Siemens, MMG-E	96847130	-	-	96306485
250	500	6	55	-	280S	MMG-G, EFF1 & EFF2	96847130	-	-	96306486
250	500	6	75	75	315S	Siemens, MMG-E	96847130	-	-	96306486
250	500	6	75	75	280M	MMG-G, EFF1 & EFF2	96847130	-	-	96306486
250	500	6	90	90	315M	Siemens, MMG-E	96847130	-	-	96306486
250	500	6	90	90	315S	MMG-G, EFF1 & EFF2	96847130	-	-	96306487
250	500	6	-	110	315L	Siemens, MMG-E	96847130	-	-	96306486
250	500	6	-	110	315M	MMG-G, EFF1 & EFF2	96847130	-	-	96306487
250	500	6	-	132	315L	Siemens, MMG-E	96847130	-	-	96306486
250	500	6	-	132	315M	MMG-G, EFF1 & EFF2	96847130	-	-	96306487
250	500	6	-	160	315L	Siemens	96847130	-	-	96306486
250	500	6	-	160	355M	MMG-E	96847130	-	-	96306486
250	500	6	-	160	315C	MMG-G, EFF1 & EFF2	96847130	-	-	96810026

Wear ring

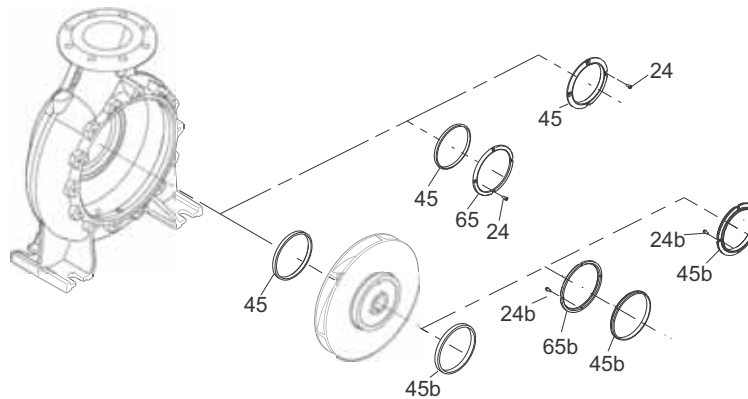

TM04 4731 1909

Material code:
A, B, C, D, E, F, G, H, S, T

Pos. 45	Pos. 45b
45: 1 x wear ring	45b: 1 x wear ring

Material code:
J, N, P, R, W

Pos. 45	Pos. 45b
45: 1 x wear ring	45b: 1 x wear ring
65: 1 x wear ring retainer	65b: 1 x wear ring retainer
24: 4 x screw	24b: 4 x screw

Material code:
I, K, L, M, U

Pos. 45	Pos. 45b
45: 1 x wear ring	45b: 1 x wear ring
24: 4 x screw	24b: 4 x screw

Material code: A, B, C, D, E, F, G, H, S, T (pump housing material cast iron)

The material code can be found in the type designation on the nameplate.

NB 32 -125 .1 /104 A -F-A BBAQE

Pump type	Wear ring inner diameter [mm]	Wear ring material				
		Bronze/brass		GG		
		A, B, C, D, E, F, G, H, S, T	A, B, C, D, E, F, G, H, S, T	A, B, C, D, E, F, G, H, S, T	A, B, C, D, E, F, G, H, S, T	
	Pos. 45	Pos. 45b	Pos. 45	Pos. 45b	Pos. 45	Pos. 45b
32 - 125.1		96810099	-	-	-	-
160.1		96810098	-	-	-	-
200.1		96810098	-	-	-	-
125		96810099	-	-	-	-
160		96810099	96810102	-	-	-
200		96810099	96810102	-	-	-
250		96810099	96810103	-	-	-
125		96810100	96810102	-	-	-
160		96810100	96810102	-	-	-
40 - 200		96810100	96810102	-	-	-
250		96810100	96810103	-	-	-
315		96810102	96797628	-	-	-
125		96810102	96810102	-	-	-
160		96810102	96810102	-	-	-
50 - 200		96810102	96810102	-	-	-
250		96810102	96810103	-	-	-
315		96810103	96797628	-	-	-
125		96810103	96810102	-	-	-
160		96810103	96810104	-	-	-
65 - 200		96810104	96810104	-	-	-
250		96810104	96797628	-	-	-
315		96810104	96797628	-	-	-
160		96810106	96810104	-	-	-
200		96810106	96797628	-	-	-
80 - 250		96810106	96797628	-	-	-
315		96810106	96797628	-	-	-
400		96797628	96810109	-	-	-

Pump type	Wear ring inner diameter [mm]	Wear ring material					
		Bronze/brass		GG			
		A, B, C, D, E, F, G, H, S, T	A, B, C, D, E, F, G, H, S, T	A, B, C, D, E, F, G, H, S, T	A, B, C, D, E, F, G, H, S, T		
	Pos. 45	Pos. 45b	Pos. 45	Pos. 45b	Pos. 45	Pos. 45b	
100 - 160				96810107	96810104	-	-
200	174	154		96810108	96797628	-	-
200	154	154		96797628	96797628	-	-
250				96797628	96797628	-	-
315				96797628	96797628	-	-
400				96810109	96810109	-	-
125 - 200				96810108	96797628	-	-
250				96810109	96810109	-	-
315				96810109	96797628	-	-
400				96810109	96810109	-	-
500				96810109	96810112	-	-
200				96810110	96810109	-	-
250	210	185		96810111	96810109	-	-
250	185	185		96810109	96810109	-	-
150 - 315.1				96810111	96810112	-	-
315.2				96810111	96810112	-	-
315				96810111	96810112	-	-
400				96810112	96810112	-	-
500				96810112	96810112	-	-
200 - 400				96939611	96939611	96939606	96939609
450				96939612	96939612	96939607	96939607
350				96939613	96939615	96939608	96939607
250 - 400				96939615	96939615	96939607	96939607
450				96939614	96939614	96939607	96939607
500				96939615	96939615	96939610	96939610

Note: Oversize pump use the same wear ring as standard pump.

Material code: I, J, K, L, M, N, P, R, W, U (pump housing materials 1.4408 or 1.4517)

Pump type	Wear ring inner diameter [mm]		Material code J, N, P, R, W				Material code I, K, L, M, U					
			ACS approval -		-		-		Yes			
			Wear ring		Carbon-graphite-filled PTFE		Carbon-graphite-filled PTFE		1.4517		1.4517	
			Screw		1.4539		1.4401		1.4539		1.4401	
	Pos. 45	Pos. 45b	Pos. 45	Pos. 45b	Pos. 45	Pos. 45b	Pos. 45	Pos. 45b	Pos. 45	Pos. 45b		
32 -	125.1		96810113	96774200	96810114	96810117	96810134	96810138	96810135	96810139		
	160.1		97939262	96774200	97939263	96810117	97939264	96810138	97939265	96810139		
	200.1		97939262	96774200	97939263	96810117	97939264	96810138	97939265	96810139		
	125		96810113	96774200	96810114	96810117	96810134	96810138	96810135	96810139		
	160		96810113	96774200	96810114	96810117	96810134	96810138	96810135	96810139		
	200		96810113	96774200	96810114	96810117	96810134	96810138	96810135	96810139		
	250		96810113	96810120	96810114	96810121	96810134	96810142	96810135	96810143		
40 -	125		96810115	96774200	96810116	96810117	96810136	96810138	96810137	96810139		
	160		96810115	96774200	96810116	96810117	96810136	96810138	96810137	96810139		
	200		96810115	96774200	96810116	96810117	96810136	96810138	96810137	96810139		
	250		96810115	96810120	96810116	96810121	96810136	96810142	96810137	96810143		
	315		96774200	96810130	96810117	96810131	96810138	96810152	96810139	96810153		
50 -	125		96774200	96774200	96810117	96810117	96810138	96810138	96810139	96810139		
	160		96774200	96774200	96810117	96810117	96810138	96810138	96810139	96810139		
	200		96774200	96774200	96810117	96810117	96810138	96810138	96810139	96810139		
	250		96774200	96810120	96810117	96810121	96810138	96810142	96810139	96810143		
	315		96810120	96810130	96810121	96810131	96810142	96810152	96810143	96810153		
65 -	125		96810120	96774200	96810121	96810117	96810142	96810138	96810143	96810139		
	160		96810120	96810124	96810121	96810125	96810142	96810146	96810143	96810147		
	200		96810124	96810124	96810125	96810125	96810142	96810146	96810147	96810147		
	250		96810124	96810130	96810125	96810131	96810146	96810152	96810147	96810153		
	315		96810124	96810130	96810125	96810131	96810146	96810152	96810147	96810153		
80 -	160		96810128	96810124	96810129	96810125	96810150	96810146	96810151	96810147		
	200		96810128	96810130	96810129	96810131	96810150	96810152	96810151	96810153		
	250		96810128	96810130	96810129	96810131	96810150	96810152	96810151	96810153		
	315		96810128	96810130	96810129	96810131	96810150	96810152	96810151	96810153		
	315*		96810128	96810130	96810129	96810131	96810150	96810152	96810151	96810153		
	400		96810130	96810132	96810131	96810133	96810152	96810154	96810153	96810155		
100 -	160		96810118	96810124	96810119	96810125	96810148	96810146	96810149	96810147		
	200		96810130	96810130	96810131	96810131	96810152	96810152	96810153	96810153		
	250		96810130	96810130	96810131	96810131	96810152	96810152	96810153	96810153		
	250*		96810130	96810130	96810131	96810131	96810152	96810152	96810153	96810153		
	315		96810130	96810130	96810131	96810131	96810152	96810152	96810153	96810153		
	315*		96810130	96810130	96810131	96810131	96810152	96810152	96810153	96810153		
125 -	200	174 154	97939252	96810130	97939253	96810131	97939254	96810152	97939255	96810153		
	200	154 154	96810130	96810130	96810131	96810131	96810152	96810152	96810153	96810153		
	250		96810132	96810132	96810133	96810133	96810154	96810154	96810155	96810155		
	250*		96810132	96810132	96810133	96810133	96810154	96810154	96810155	96810155		
	315		96810132	96810130	96810133	96810131	96810154	96810152	96810155	96810153		
	400		96810132	96810132	96810133	96810133	96810154	96810154	96810155	96810155		
	500		96810132	96810132	96810133	96810133	96810154	96810154	96810155	96810155		
150 -	200		97939256	96810132	97939257	96810133	97939258	96810154	97939259	96810155		
	250	210 185	96887266	96810132	96887264	96810133	96887262	96810154	96887255	96810155		
	250	185 185	96810132	96810132	96810133	96810133	96810154	96810154	96810155	96810155		
	315.1		97739720	96887266	97739719	96887264	97739717	96887262	97739700	96887255		
	315.2		97739720	96887266	97739719	96887264	97739717	96887262	97739700	96887255		
	315		97739720	96887266	97739719	96887264	97739717	96887262	97739700	96887255		
	400		97739720	97739720	97739719	97739719	97739717	97739717	97739700	97739700		
200 -	400*		97739720	97739720	97739719	97739719	97739717	97739717	97739700	97739700		
	500		97739720	97739720	97739719	97739719	97739717	97739717	97739700	97739700		
	400		-	-	-	-	-	-	-	-		
	450		-	-	-	-	-	-	-	-		
250 -	350		-	-	-	-	-	-	-	-		
	400		-	-	-	-	-	-	-	-		
	450		-	-	-	-	-	-	-	-		
	500		-	-	-	-	-	-	-	-		

* Oversize pump.

Note: Oversize pump use the same wear ring as standard pump.

Impeller

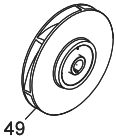

TM04 4729 1909

Find the impeller in Grundfos Product Center and contact your local sales company.

Nut, washer and key for impeller

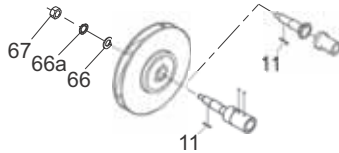

TM04 4730 1909

Material code:

A, B, C, D, E, F, G, H, K, M, N, P, S

- 11: 1 x key
- 67: 1 x nut
- 66a: 1 x lock washer
- 66: 1 x washer

Material code:

I, J, L, R, T, U, W

- 11: 1 x key
- 67: 1 x nut
- 66a: 1 x lock washer
- 66: 1 x washer

The material code can be found in the type designation on the nameplate.

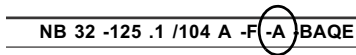

Pump type	Shaft seal dia.	Material code	
		A, B, C, D, E, F, G, H, K, M, N, P, S	I, J, L, R, T, U, W
32 -	125.1	28	96939128 96939129
	160.1	28	96939128 96939129
	200.1	28	96939128 96939129
	125	28	96939128 96939129
	160	28	96939128 96939129
	200	28	96939128 96939129
40 -	125	28	96939128 96939129
	160	28	96939128 96939129
	200	28	96939128 96939129
50 -	125	28	96939128 96939129
	160	28	96939128 96939129
	200	28	96939128 96939129
65 -	250	28	96939128 96939129
	315	38	96939130 96939131
	125	28	96939128 96939129
80 -	160	28	96939128 96939129
	200	38	96939130 96939131
	250	38	96939130 96939131
100 -	315	38	96939130 96939131
	400	48	96939132 96939133
	160	28	96939128 96939129
125 -	200	38	96939130 96939131
	250	38	96939130 96939131
	250*	48	96939132 96939133
150 -	315	38	96939130 96939131
	400	48	96939132 96939133
	400*	55	96939134 96939135
200 -	500	60	96939137 96939138
	200	38	96939130 96939131
	250	48	96939132 96939133
250 -	315.1	48	96939132 96939133
	315.2	48	96939132 96939133
	315	48	96939132 96939133
500 -	400	48	96939132 96939133
	400*	55	96939134 96939135
	500	60	96939137 96939138
750 -	400	55	96939134 96939135
	450	55	96939134 96939135
	350	55	96939134 96939135
1000 -	400	55	96939134 96939135
	450	60	96939137 96939138
	500	60	96939137 96939138

* Oversize pump.

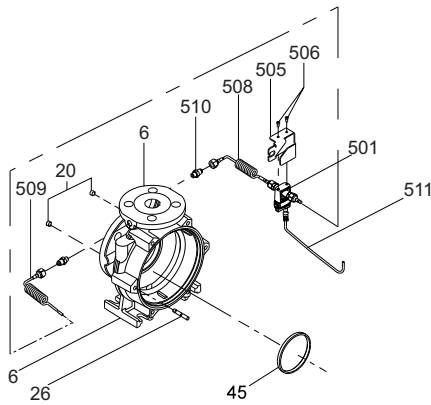
Sensor for NBE Series 2000

TM07 3633 0119

Kit, pump housing

- 6: 1 x pump housing
 20: hexagon socket head plug (can be 2/3/4 pcs)
 26: staybolt (can be 6/8/12 pcs)
 45: 1 x wear ring

Kit, differential-pressure sensor

- 501: 1 x sensor
 506: 2 x screw
 511: 1 x cable (including connector to sensor)

Kit, sensor bracket

- 505: 1 x sensor bracket

Kit, capillary tube

- 508: 1 x capillary tube
 509: 1 x capillary tube
 510: 2 x adapter plug

Kit, cable

- 511: 1 x cable (including connector to sensor)

Kit, pump housing

Pump type	Pump housing		
	With feet	Without feet	
32-	125.1	99563387	-
	125	99563388	-
	160.1	99563385	-
	160	99563386	-
	200.1	99563383	-
	200	99563384	-
	250	99492504	-
40-	125	99563382	-
	160	99563381	-
	200	99563379	99563380
	250	99563377	99563378
	315	99492511	-
50-	125	99563376	-
	160	99563374	99563375
	200	99563372	99563373
	250	99563370	99563371
65-	315	99492519	-
	125	99563366	-
	160	99563364	99563365
80-	200	99563362	99563363
	250	99563359	-
	315	99563358	-
100-	160	99563340	99563341
	200	99563339	-
125-	250	99563338	-
	160	99492535	-
	200	99492537	-
150-	200	99492538	-
	200	99563389	-

Kit, differential-pressure sensor

0-4 bar	0-6 bar	0-10 bar
99562724	99562725	99562726

Kit, bracket for sensor

99562727

Kit, capillary tube

99184237

Kit, cable

99562728

