

# SB/SBA



Further product  
documentation



[net.grundfos.com/qr/i/99057358](https://net.grundfos.com/qr/i/99057358)

be  
think  
innovate

**GRUNDFOS** 

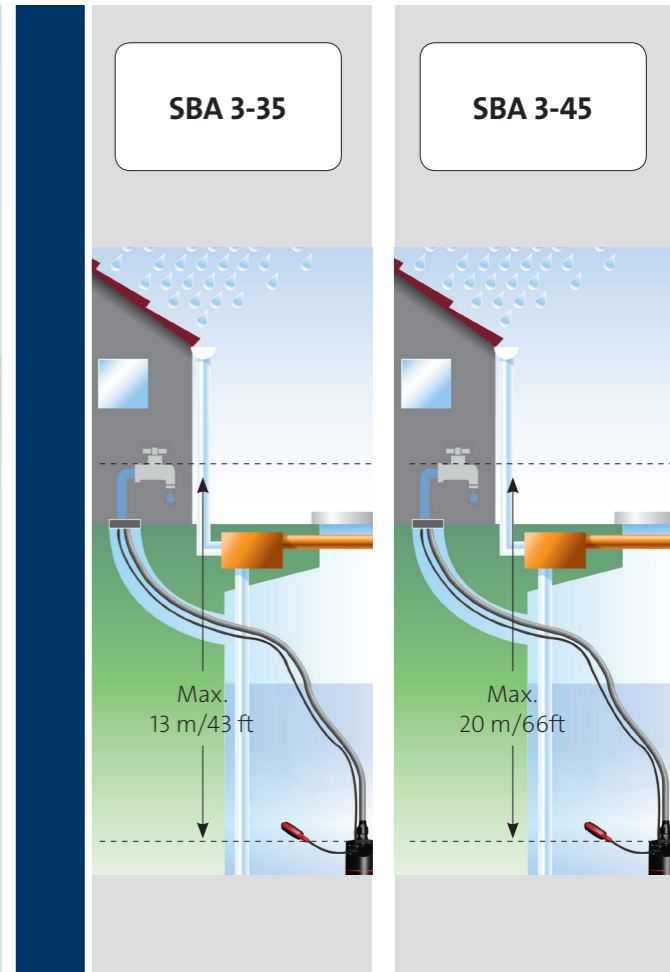
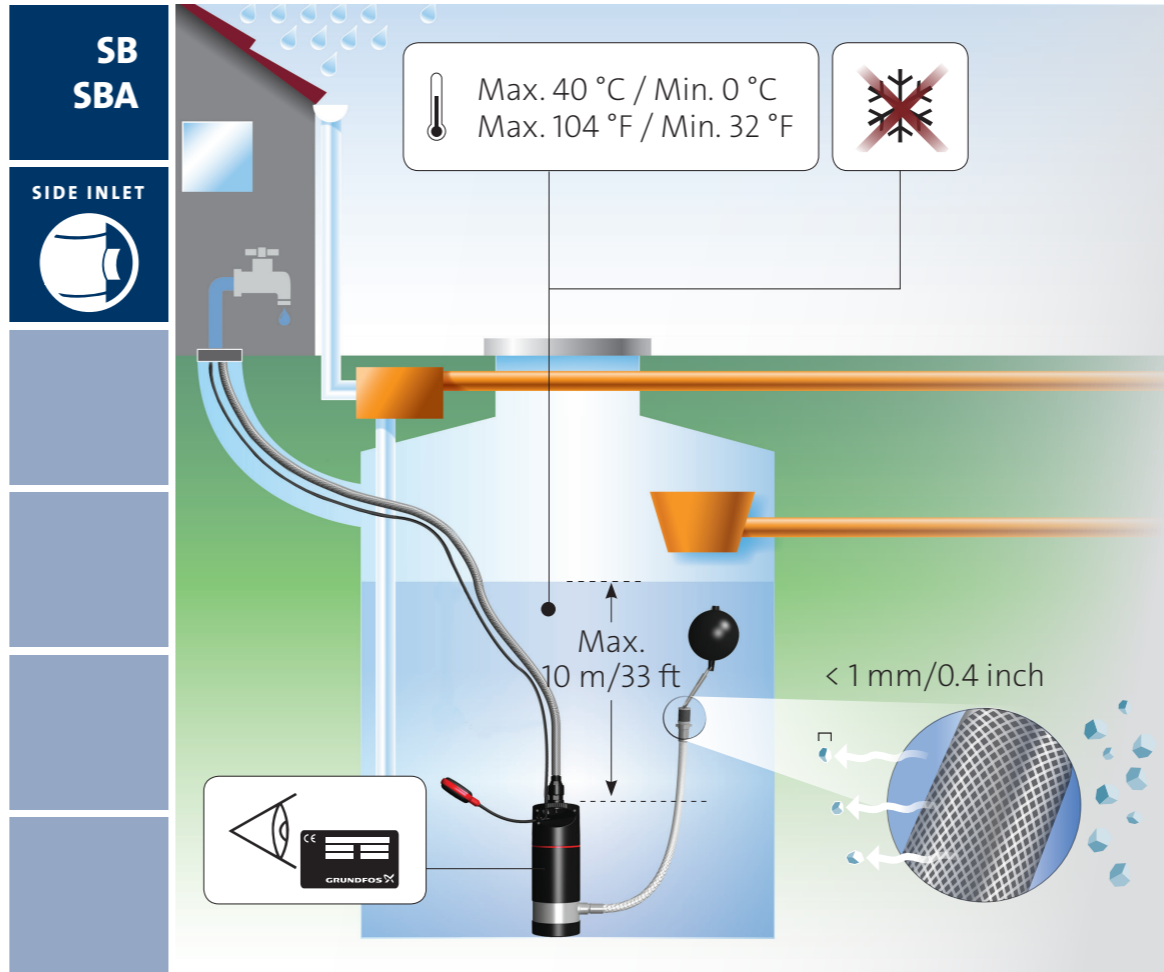
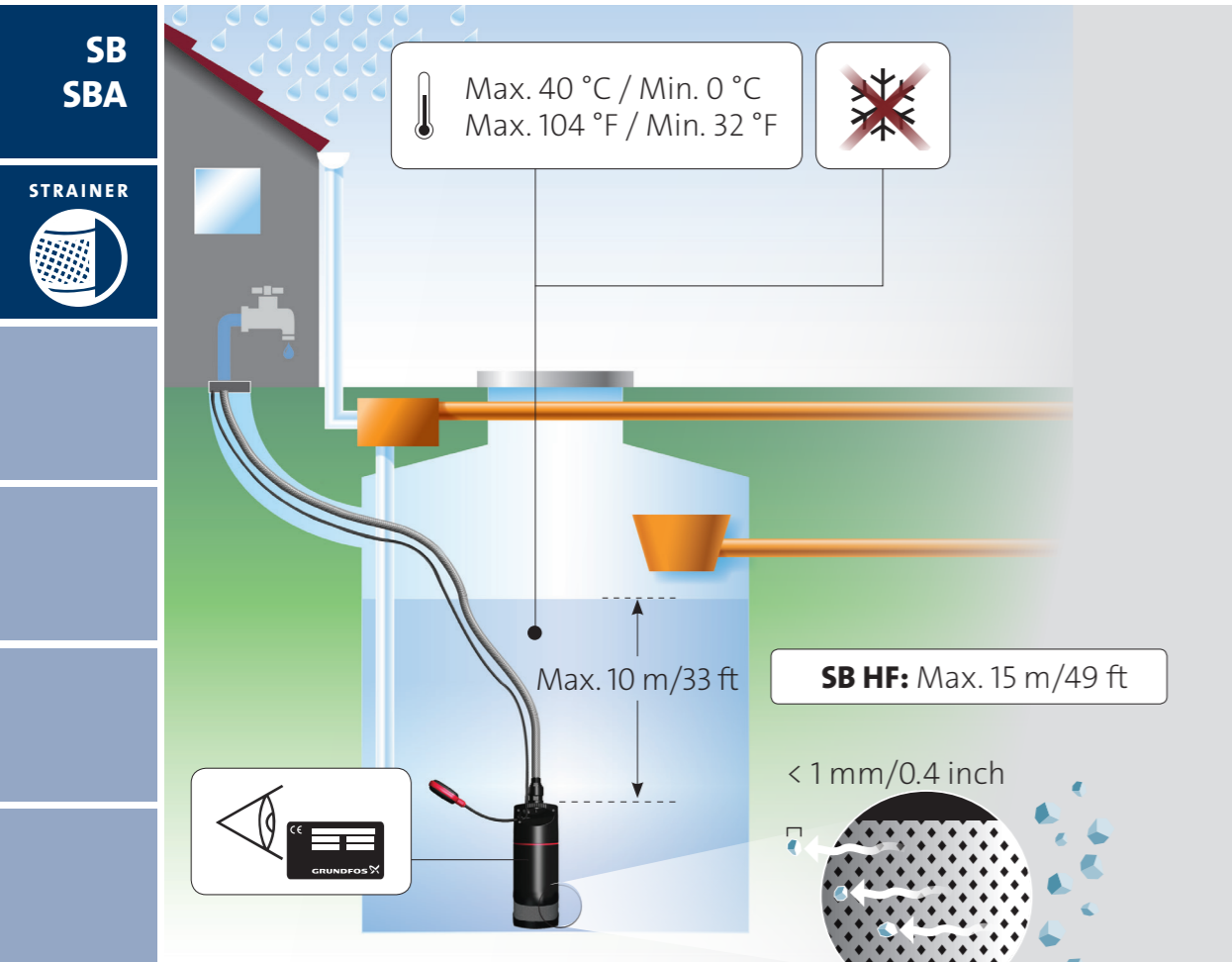

**SB**

**STRAINER**

1

2

SB HF

**SBA**

**STRAINER**

1

2

**SB**

**SIDE INLET**

1

2

3

**SBA**

**SIDE INLET**

1

2

3

**SB**  
**SBA**

STRAINER

SIDE INLET

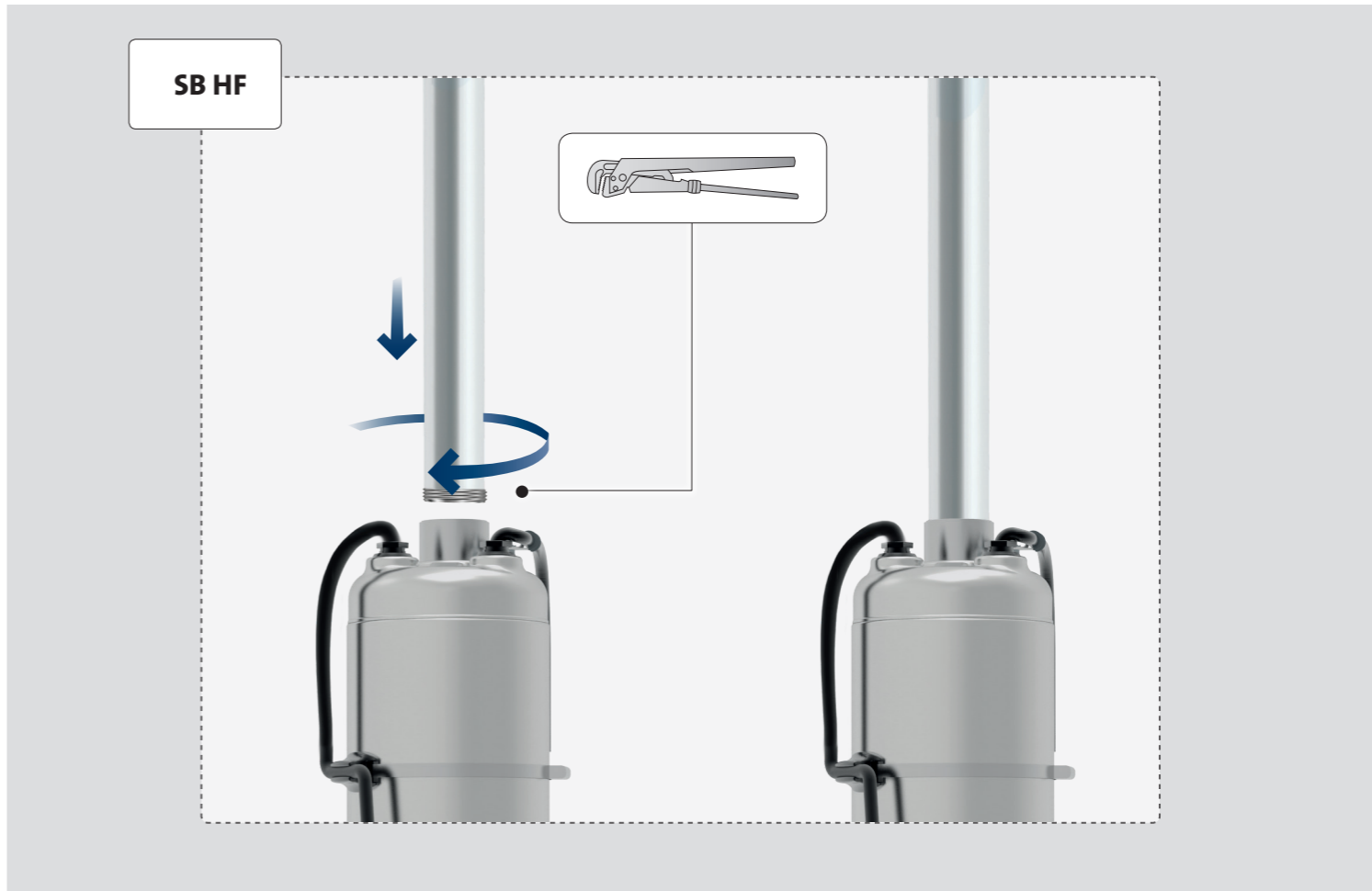
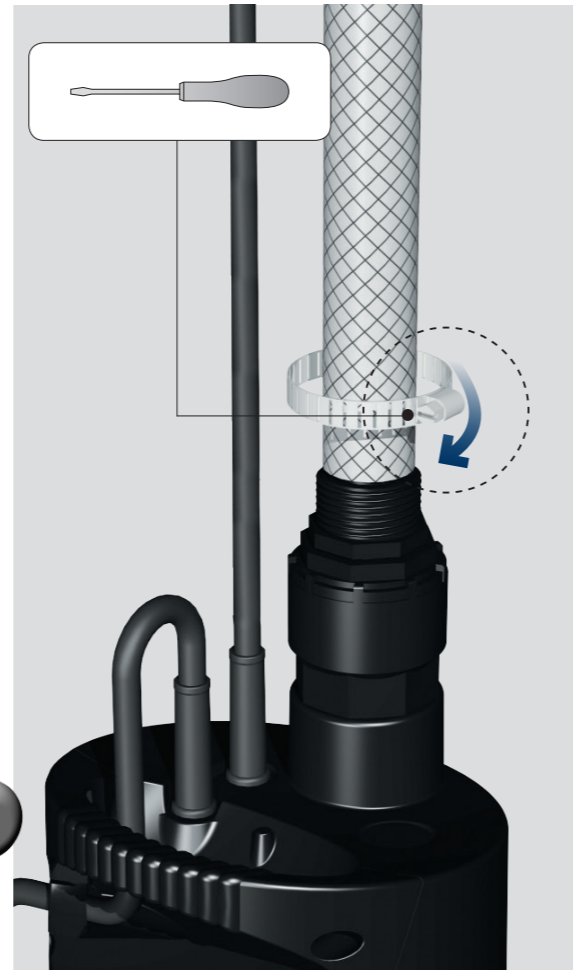
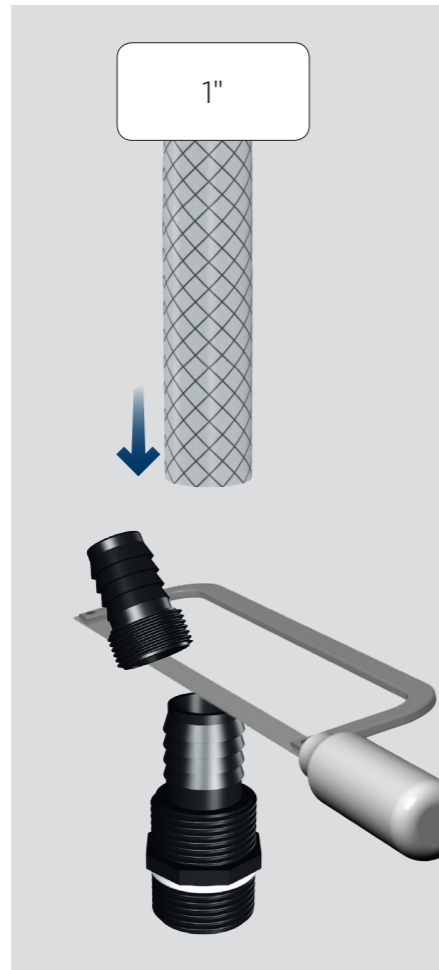
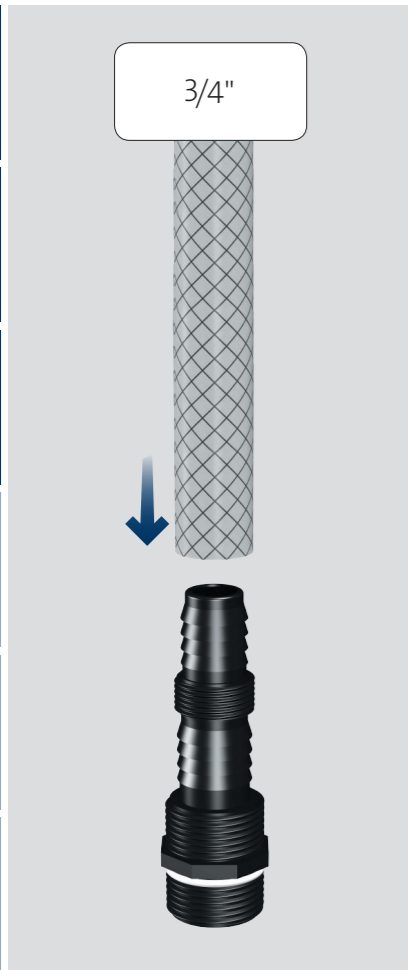

- SB**
- SBA**
- STRAINER**
- SIDE INLET**

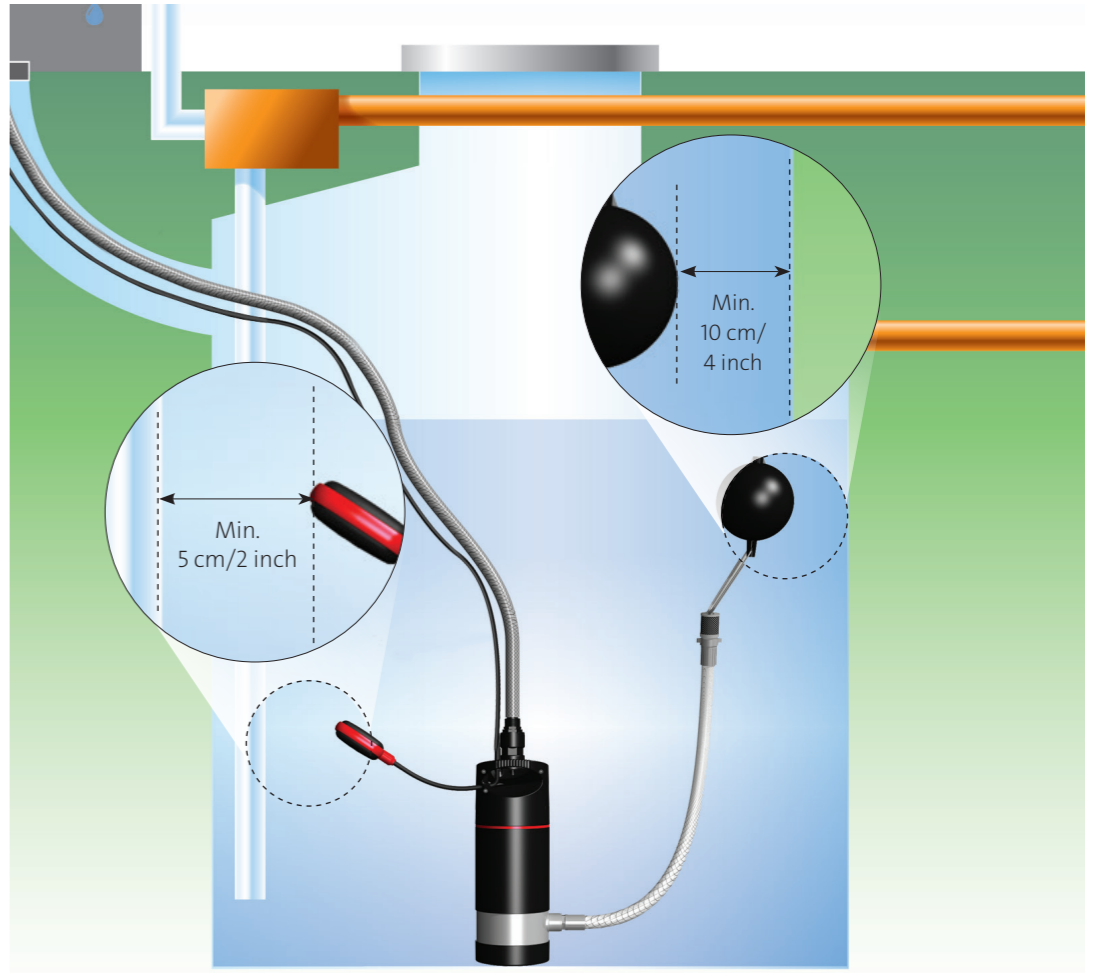
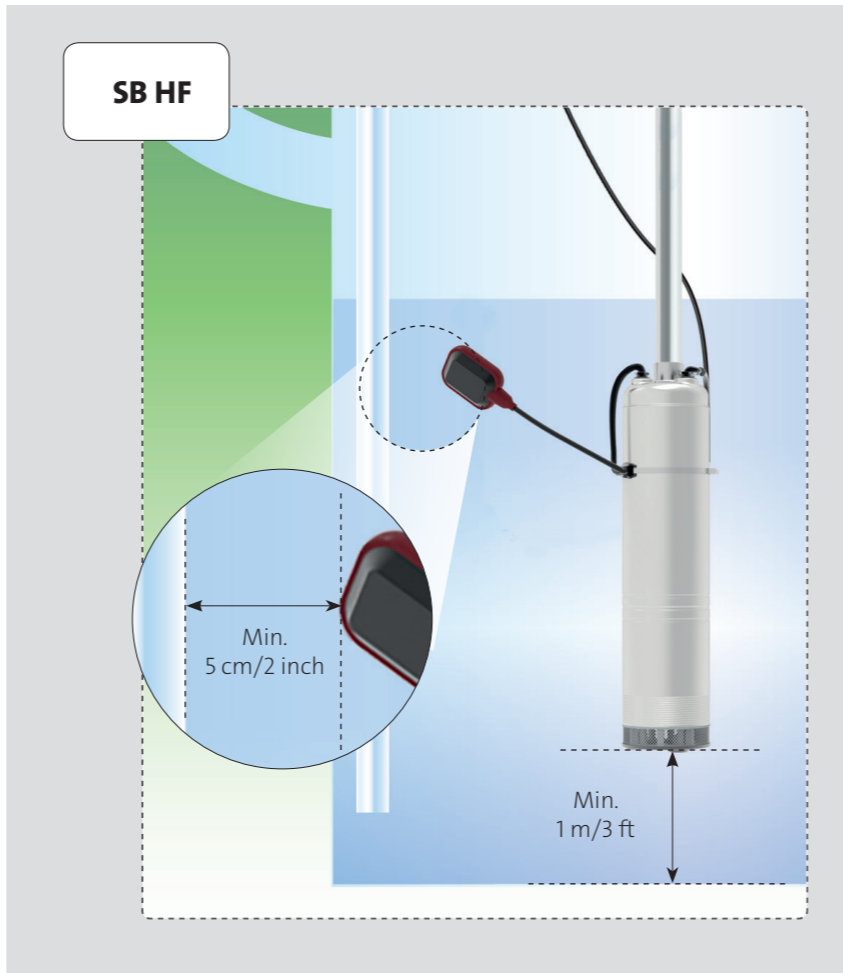
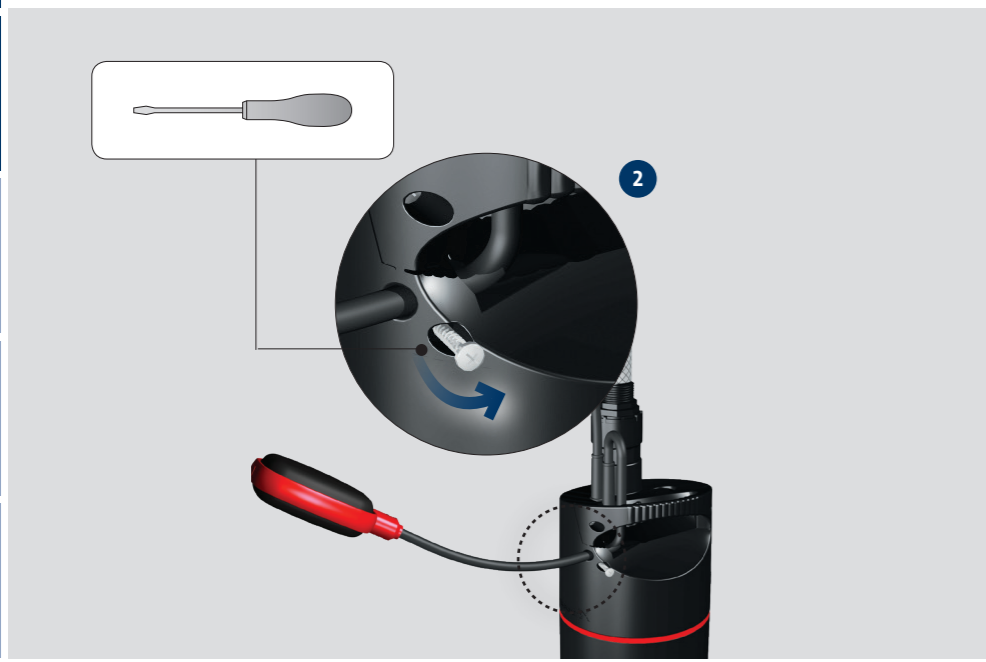
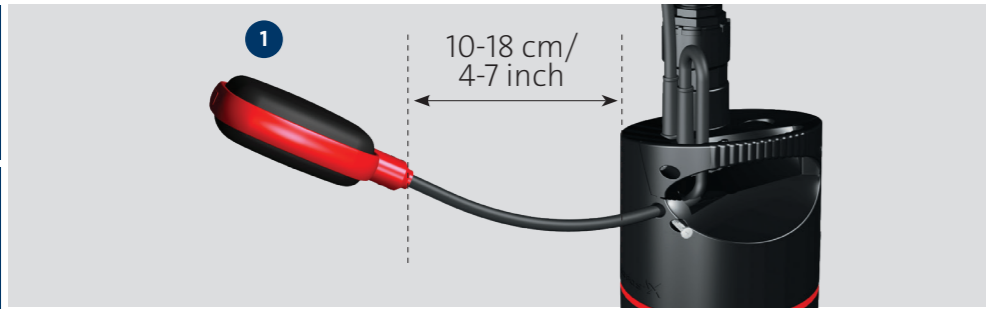



**SB**

**STRAINER**

**SIDE INLET**

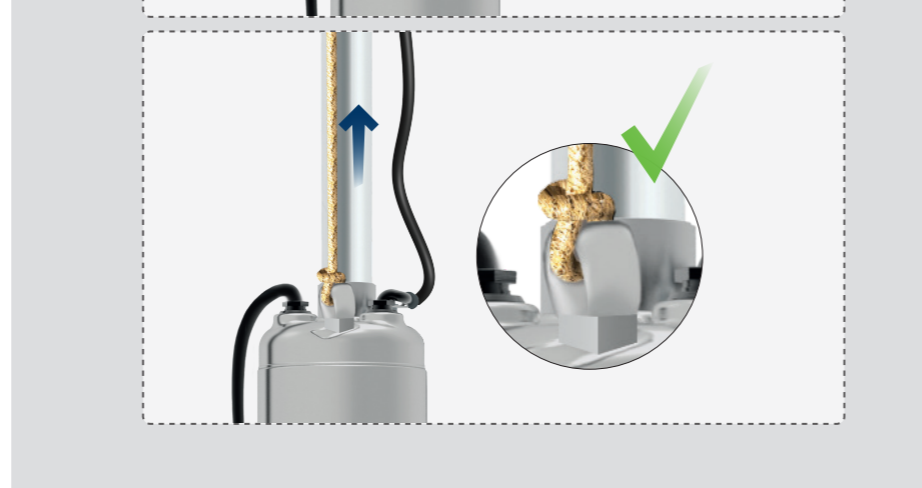
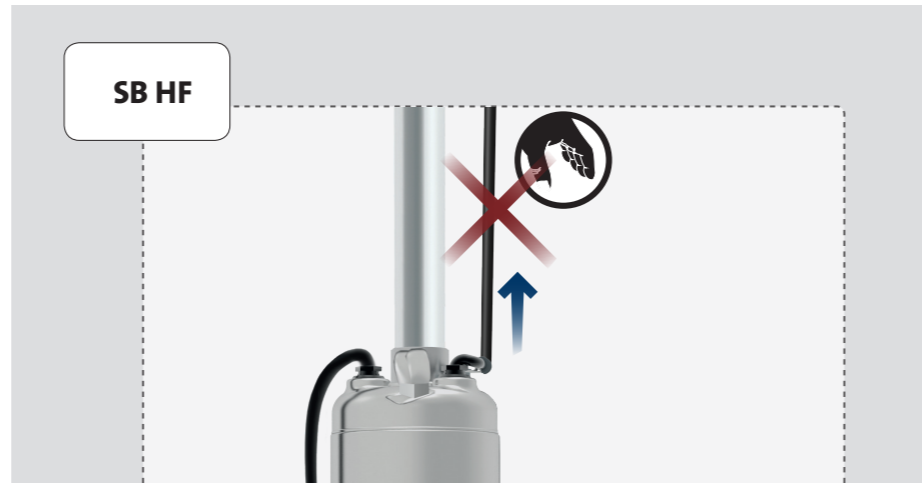
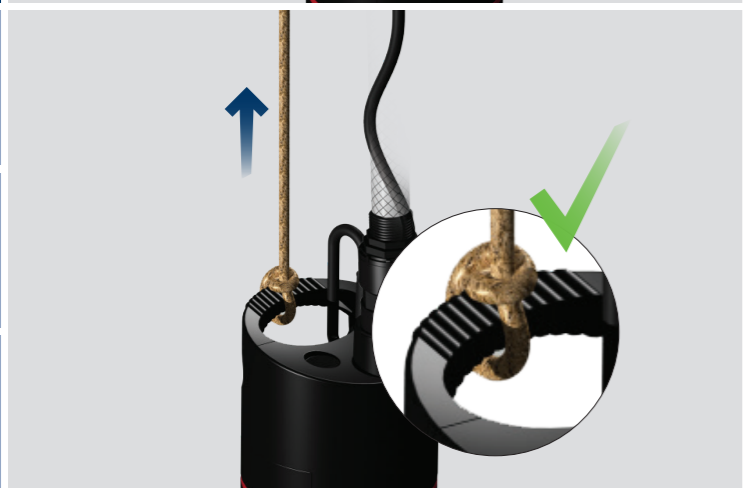

**SBA**

**STRAINER**



**SBA**

**SIDE INLET**

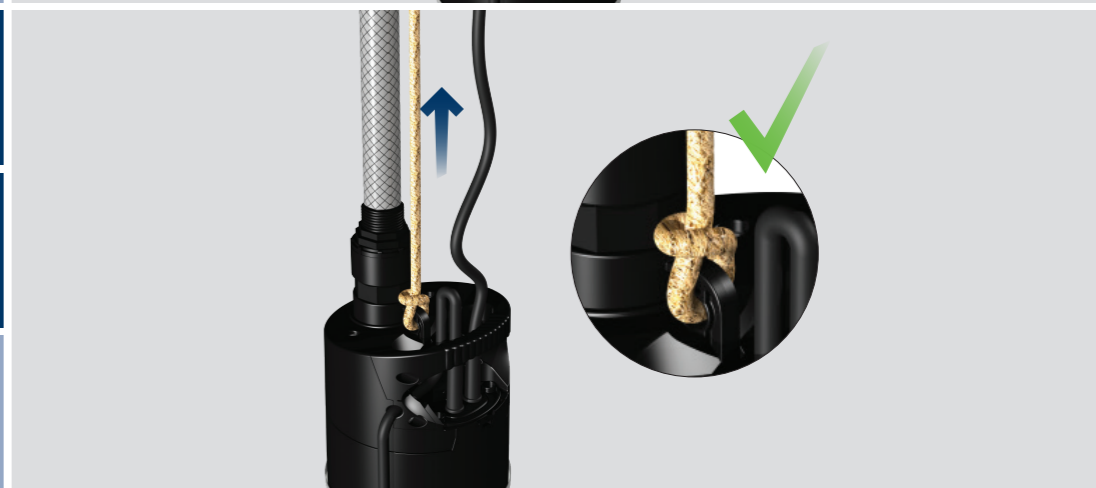

SB  
SBA

STRAINER

SIDE INLET

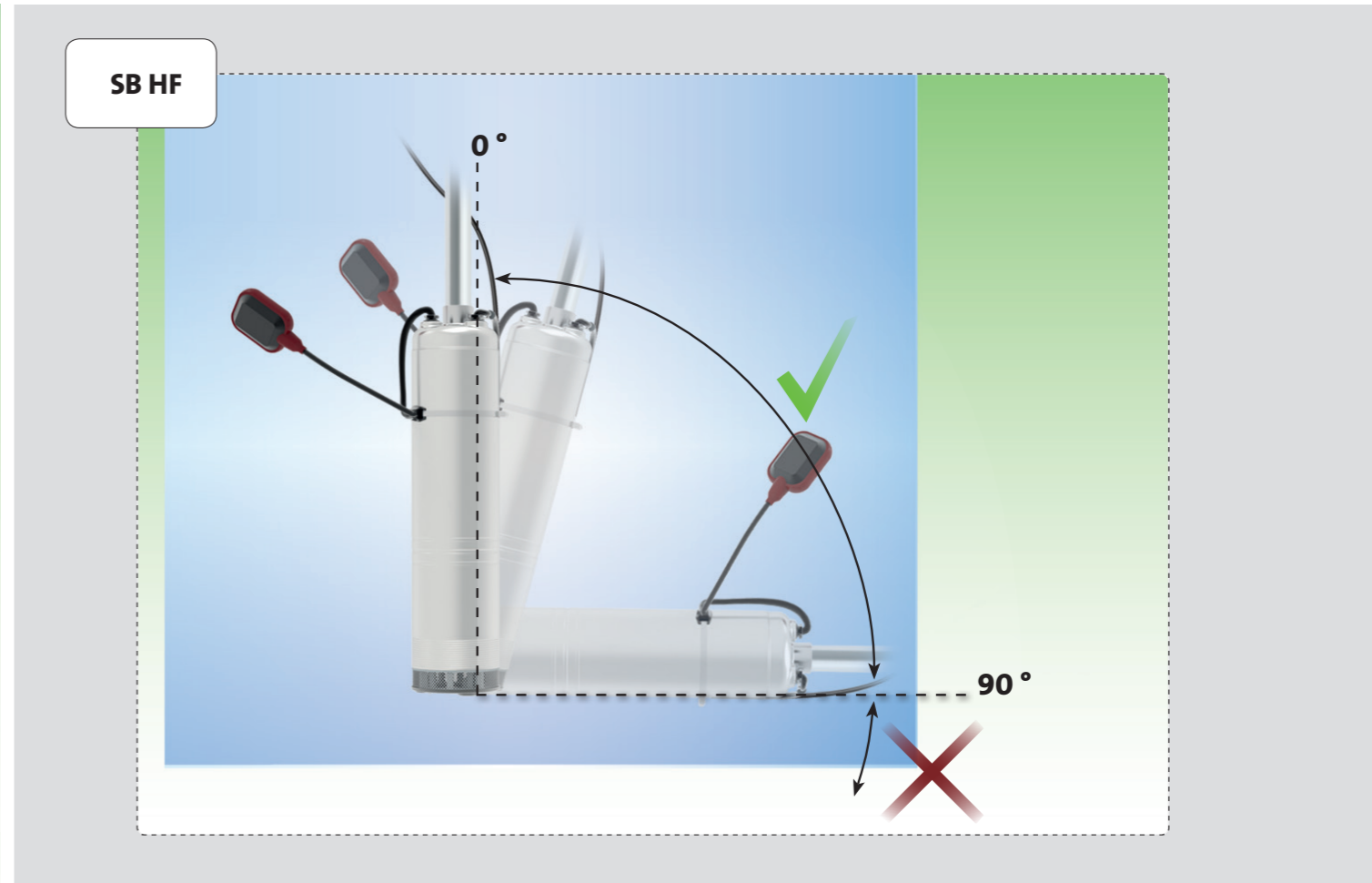
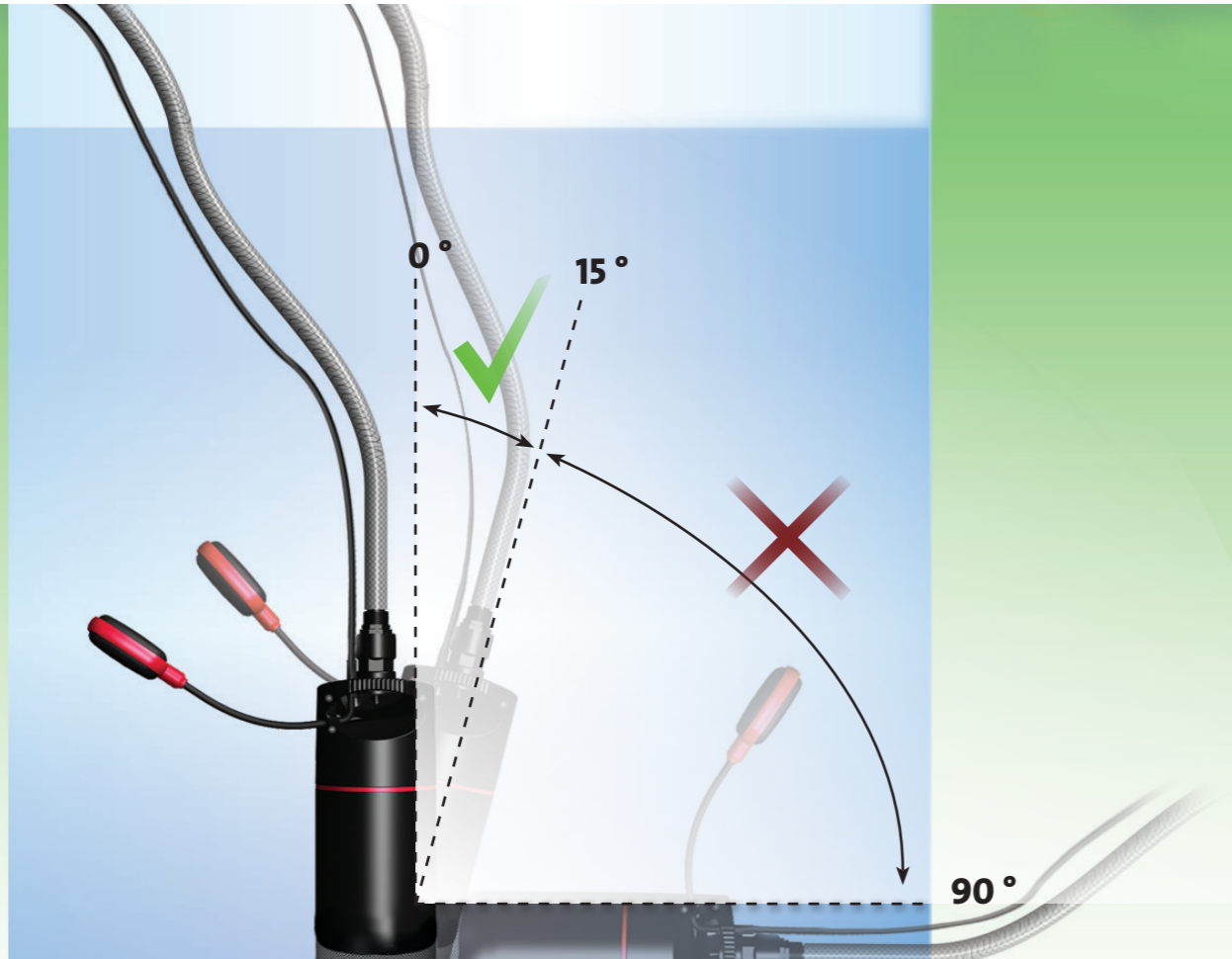

**SB**  
**SBA**

STRAINER

SIDE INLET



Max. 20 starts per 60 minutes.

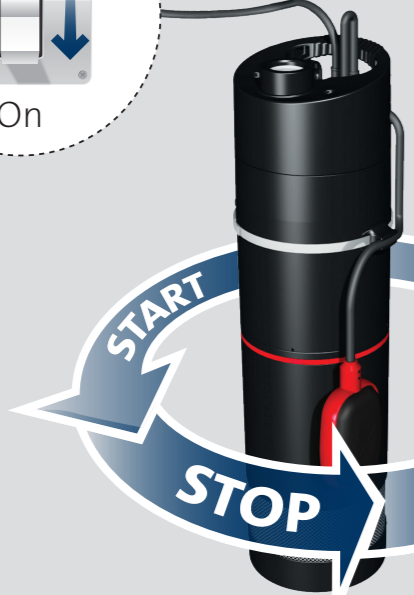
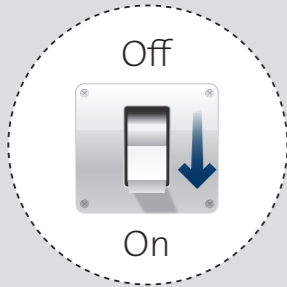

**SB HF**



Max. 30 starts per 60 minutes.

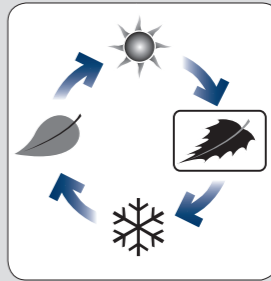
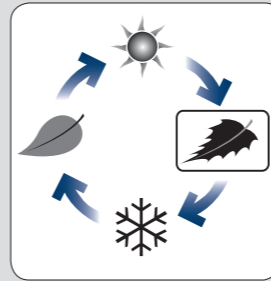
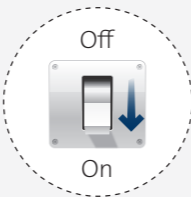



be think innovate

---

98159397 0418

ECM: 1232283

**GRUNDFOS Holding A/S**  
Poul Due Jensens Vej 7  
DK-8850 Bjerringbro  
Tel: +45 87 50 14 00  
[www.grundfos.com](http://www.grundfos.com)

Pumpland.ru

**GRUNDFOS** 

The name Grundfos, the Grundfos logo, and be think innovate are registered trademarks owned by Grundfos Holding A/S or Grundfos A/S, Denmark. All rights reserved worldwide.