

Modbus for MP 204

CIU 200 Modbus RTU

CIU 250 GSM/GPRS

CIU 500 Ethernet for Modbus TCP

Functional profile and user manual



Original functional profile and user manual.

CONTENTS

	Page		
1. Symbols used in this document	2	13. Fault finding	34
2. Introduction	3	13.1 CIU 200	34
2.1 About this functional profile	3	13.2 CIU 250	36
2.2 Assumptions	3	13.3 CIU 500	38
2.3 Definitions and abbreviations	3	14. Modbus RTU rotary switch addresses	40
3. System description	4	15. Grundfos alarm and warning codes	41
3.1 Modbus	4		
3.2 CIU 200 Modbus RTU	4		
3.3 CIU 250 Modbus GSM/GPRS	4		
3.4 CIU 500 Modbus TCP	4		
4. Specifications	5		
4.1 CIU unit	5		
4.2 CIU 200 Modbus RTU	5		
4.3 CIU 250 GSM/GPRS	6		
4.4 CIU 500 Modbus TCP	6		
5. Modbus RTU, CIM 200 setup	7		
5.1 Setting the Modbus transmission speed	7		
5.2 Setting the parity	8		
5.3 Modbus address selection	8		
5.4 Termination resistor	8		
5.5 Status LEDs	9		
6. Modbus GSM/GPRS, CIM 250 setup	10		
6.1 Installation	10		
6.2 Status LEDs	11		
7. Modbus TCP, CIM 500 setup	12		
7.1 Connecting the Ethernet cable	12		
7.2 Setting the Industrial Ethernet protocol	12		
7.3 Setting up the IP addresses	12		
7.4 Establish connection to the Web server	13		
7.5 Status LEDs	13		
7.6 DATA and LINK LEDs	13		
8. Modbus function code overview	14		
9. Modbus register overview	15		
9.1 Register block overview	15		
9.2 CIM configuration register block	16		
9.3 CIM status register block	17		
9.4 GSM real time clock	17		
9.5 MP 204 control register block	18		
9.6 MP 204 status register block	19		
9.7 Alarm code module register 00204	21		
9.8 Warning bits registers 00205 and 00206	22		
9.9 MP 204 data register block	23		
9.10 Alarm simulation register block	24		
9.11 User register block	24		
10. Modbus RTU commissioning, step-by-step guides	25		
10.1 Hardware setup (CIU 200)	25		
10.2 Hardware setup (CIU 250 GSM call-up)	25		
10.3 Hardware setup (CIU 250 GPRS connection)	25		
10.4 Modbus TCP communication setup (CIU 500)	26		
11. Detailed descriptions of functionality	27		
11.1 GSM	27		
11.2 GPRS	27		
12. Modbus RTU telegram examples	30		
12.1 Modbus telegram overview	30		
12.2 Read holding registers (0x03)	30		
12.3 Read input registers (0x04)	30		
12.4 Write single register (0x06)	31		
12.5 Write multiple registers (0x10)	31		
12.6 Diagnostics (0x08)	31		
12.7 Diagnostics register interpretation	32		
12.8 Diagnostics: return query data	32		
12.9 Reading the CIM configuration register block	32		
12.10 Tripping the MP 204	33		
12.11 Resetting an alarm	33		

1. Symbols used in this document**Warning**

If these safety instructions are not observed, it may result in personal injury.



If these safety instructions are not observed, it may result in malfunction or damage to the equipment.



Notes or instructions that make the job easier and ensure safe operation.

2. Introduction

2.1 About this functional profile

This functional profile describes these modules/units:

- CIU 200 Modbus RTU
- CIU 250 Modbus GSM/GPRS
- CIU 500 Modbus Ethernet for Modbus TCP

This functional profile applies to the Grundfos MP 204 motor protector.

The data in this document are subject to change without prior notice. Grundfos cannot be held responsible for any problems caused directly or indirectly by using information in this functional profile.

2.2 Assumptions

This functional profile assumes that the reader is familiar with commissioning and programming of Modbus devices. The reader should also have some basic knowledge of the Modbus protocol and technical specifications.

It is also assumed that an existing Modbus network with a Modbus master is present.

2.3 Definitions and abbreviations

0b	Prefix for a binary number
0x	Prefix for a hexadecimal number
3G	Third-generation mobile telephony network
4G	Fourth-generation mobile telephony network
ARP	Address resolution protocol. Translates IP addresses into MAC addresses.
Auto-MDIX	Ensures that both cross-over cable types and non-cross-over cable types can be used.
CAT5	Ethernet cable type with four twisted pairs of wires
CAT5e	Enhanced CAT5 cable with better performance
CAT6	Cable with very high performance
CIM	Communication Interface Module
CIU	Communication Interface Unit
CRC	Cyclic Redundancy Check. A data error detection method.
CSD	Circuit Switched Data. Connection is established via a fixed connection (a physical circuit or a reserved data channel).
DHCP	Dynamic host configuration protocol. Used to configure network devices so that they can communicate on an IP network.
DNS	Domain name system. Used to resolve host names to IP addresses.
GENIbus	Proprietary Grundfos fieldbus standard
GENIpro	Proprietary Grundfos fieldbus protocol
GPRS	General Packet Radio Service. Technology to achieve TCP/IP communication and internet access via GSM.
Grundfos GO	A Grundfos handheld remote control device for controlling Grundfos products via infrared or radio. Based on smart phone technology.
GSM	Global System for Mobile communications
H	Head (pressure)
HTTP	HyperText transfer protocol. The protocol commonly used to navigate the world wide web.
IANA	Internet Assigned Numbers Authority
IP	Internet protocol
LED	Light-Emitting Diode
MAC	Media Access Control. Unique network address for a piece of hardware.

Modbus	A serial communications protocol commonly used in industry and building automation systems
Modbus RTU	Modbus is a fieldbus used worldwide. The RTU version is used for wired networks (CIM 200) and for call-up connections over telephone networks (CIM 250).
Modbus TCP	Modbus is a fieldbus used worldwide. The TCP version is adapted for use as an application protocol on TCP/IP using either GPRS (CIM 250) or Ethernet (CIM 500) as basis.
MP 204	Grundfos Motor Protector
PIN	Personal Identification Number. For SIM cards.
Ping	Packet InterNet Groper. A software utility that tests connectivity between two TCP/IP hosts.
PUK	Personal Unblocking Key. For SIM cards.
Q	Flow rate
R100	Grundfos handheld infrared remote control
SELV	Separated or Safety Extra-Low Voltage
SELV-E	Separated or Safety Extra-Low Voltage with earth connection
SIM	Subscriber Identity Module. SIM card.
SMA	SubMiniature version A. Coaxial radio signal cable connection standard.
SMTP	Simple Mail Transfer Protocol
SNTP	Simple network time protocol. Used for clocks synchronization between computer systems.
TCP	Transmission control protocol. Protocol for Internet communication and Industrial Ethernet communication.
TCP/IP	Transmission Control Protocol/Internet Protocol. Protocol for Internet communication.
Transmission speed	Bits transferred per second, bits/s
URL	Uniform Resource Locator. The IP address used to connect to a server.
UTC	Coordinated Universal Time. The primary time standard by which the world regulates clocks and time.
UTF-8	Unicode Transformation Format. Character encoding.
VPN	Virtual Private Network. A network using the Internet to connect nodes. These systems use encryption and other security mechanisms to ensure that only authorised users can access the network and that the data cannot be intercepted.

3. System description

3.1 Modbus

The system diagrams provide an overview for the different technologies of how to connect the CIU to the Grundfos MP 204 (electronic motor protector, connected to a Grundfos pump) that is to be connected to a Modbus network.

CIU

The CIU solution is a box with a power supply module and a CIM Modbus module. It can either be mounted on a DIN rail or on a wall.

3.2 CIU 200 Modbus RTU

The CIU 200 offers a Modbus RTU connection to the MP 204.

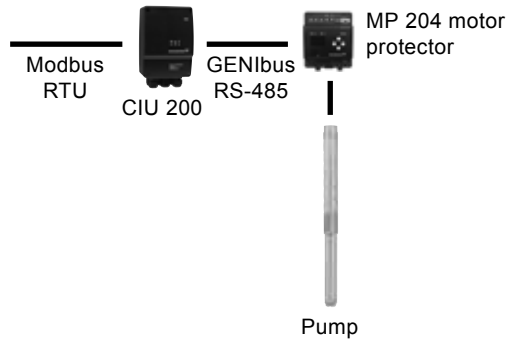

TM04 4288 1109

Fig. 1 Grundfos SP pump connected to an MP 204 which is then connected to Modbus RTC via a CIU 200

3.3 CIU 250 Modbus GSM/GPRS

Remote communication via the CIU 250 can be established by using one of the following options:

- Modbus RTU protocol via a GSM connection
- Modbus TCP protocol via a GPRS connection
- SMS commands from a mobile phone.

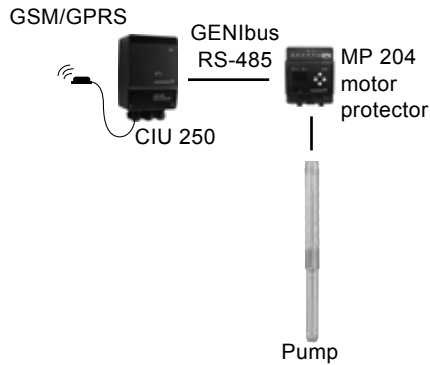

TM04 7444 0610

Fig. 2 CIU 250 solution for the MP 204 connected to an SP pump

Note 3G/4G are not supported via CIU 250.

3.4 CIU 500 Modbus TCP

The CIU 500 offers a Modbus TCP connection to the MP 204.

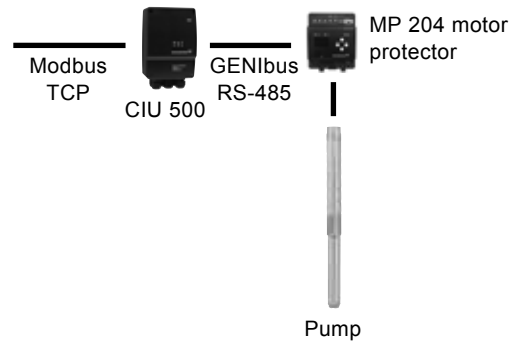

TM04 4288 1109

Fig. 3 Grundfos SP pump connected to an MP 204 which is then connected to Modbus TCP via a CIU 500

4. Specifications

4.1 CIU unit

General data	Description	Comments
Ambient humidity	30 % to 95 %	Relative, non-condensing.
Operating temperature	-20 °C to +45 °C	
Storage temperature	-25 °C to +70 °C	
Battery, lithium-ion	The battery will only be charged if the battery temperature is within 0 °C to +45 °C.	CIU 250 only.
GENIbus visual diagnostics	LED2	Will be in one of these states: Off, constantly green, flashing red, constantly red. See section 5.5 Status LEDs .
Power supply (CIU)	24-240 V	Located in the CIU.
GENIbus connection type (CIU)	RS-485, 3-wire + screen	Conductors: A, B and Y.
CIU box enclosure class	IP54	
CIU box dimensions (H x W x D)	182 x 108 x 82 mm	

4.2 CIU 200 Modbus RTU

The table below provides an overview of the specifications for the Grundfos CIU 200. For further details, please refer to the specific sections of this functional profile.

Modbus RTU specifications	Description	Comments
Modbus connector	Screw-type terminal	3 pins. See section 5. Modbus RTU, CIM 200 setup .
Modbus connection type	RS-485, 2-wire + common	Conductors: D0, D1 and Common. See section 5. Modbus RTU, CIM 200 setup .
Maximum cable length	1200 m	Equals 4000 ft.
Slave address	1-247	Set via rotary switches SW6 and SW7. See section 5.3 Modbus address selection .
Line termination	On or Off	Set via DIP switches SW1 and SW2. See section 5.4 Termination resistor .
Recommended cable cross-section	0.20 - 0.25 mm ²	AWG24 or AWG23.
Supported transmission speeds	1200*, 2400*, 4800*, 9600, 19200, 38400 bits/s	Set via DIP switches SW4 and SW5. See section 5.1 Setting the Modbus transmission speed .
Start bit	1	Fixed value.
Data bits	8	Fixed value.
Stop bits	1 or 2	Set via DIP switch SW3. See section 5.2 Setting the parity .
Parity bit	Even parity, odd parity* or no parity	Set via DIP switch SW3. See section 5.2 Setting the parity .
Modbus visual diagnostics	LED1	Off, flashing green, flashing red, constantly red. See section 5.5 Status LEDs .
Maximum number of Modbus devices	32	Using repeaters, this number can be increased. Legal address range is 1-247.
Maximum Modbus telegram size	256 bytes	Total length. Node address and CRC included. See section 12. Modbus RTU telegram examples .

* Can only be set via software.

4.3 CIU 250 GSM/GPRS

The table below provides an overview of the specifications for the Grundfos CIU 250. For further details, please refer to the specific sections of this functional profile.

Modbus GSM/GPRS specifications	Description	Comments
Data protocol	Modbus RTU/Modbus TCP	GSM call-up uses RTU. GPRS uses TCP.
Slave address	Factory 231 (0xE7)	Can be changed via Modbus register 00003, SoftwareDefinedModbusAddress.
GSM/GPRS visual diagnostics	LED1	See section 6.2 Status LEDs .
Maximum Modbus telegram size	260 bytes	Total Modbus TCP/IP application data unit. See fig. 20 .

4.4 CIU 500 Modbus TCP

The table below provides an overview of the specifications for the Grundfos CIU 500 for Modbus TCP. For further details, please refer to the specific sections of this functional profile.

Modbus TCP specifications	Description	Comments
Application layer	DHCP, HTTP, Ping, FTP, SMTP, SNMP, Modbus TCP	Rotary switch in position 1.
Transport layer	TCP	
Internet layer	Internet protocol V4 (IPv4)	
Link layer	ARP, media access control (Ethernet)	
Ethernet cable	Screened/unscreened, twisted-pair cables, CAT5, CAT5e or CAT6	Supports auto cable-crossover detecting (Auto-MDIX).
Maximum cable length	100 metres at 10/100 Mbits/s	Corresponds to 328 feet.
Transmission speed	10 Mbits/s, 100 Mbits/s	Auto-detected.
Industrial Ethernet protocols	PROFINET IO, Modbus TCP	Selected with rotary switch, section 7.2 Setting the Industrial Ethernet protocol .

5. Modbus RTU, CIM 200 setup

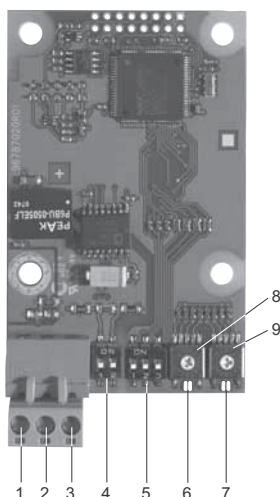

Fig. 4 CIM 200 Modbus module

Pos.	Designation	Description
1	D1	Modbus terminal D1 (positive data signal)
2	D0	Modbus terminal D0 (negative data signal)
3	Common/GND	Modbus terminal Common/GND
4	SW1/SW2	On/off switches for termination resistor
5	SW3/SW4/SW5	Switches for selection of Modbus parity and transmission speed
6	LED1	Red/green status LED for Modbus communication
7	LED2	Red/green status LED for internal communication between the CIU 200 and the MP 204
8	SW6	Hex switch for setting the Modbus address (four most significant bits)
9	SW7	Hex switch for setting the Modbus address (four least significant bits)

A screened, twisted-pair cable must be used. The cable screen must be connected to protective earth at both ends.

Recommended connection

Modbus terminal	Colour code	Data signal
D1-TXD1	Yellow	Positive
D0-TXD0	Brown	Negative
Common/GND	Grey	Common/GND

5.1 Setting the Modbus transmission speed

The transmission speed must be set correctly before the CIU 200 Modbus module is ready to communicate with the Modbus network. DIP switches SW4 and SW5 are used for setting the transmission speed. See fig. 5.

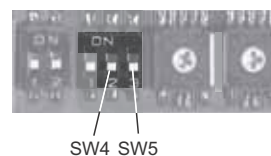

Fig. 5 Modbus transmission speed

DIP switch settings

Available transmission speeds in bits/s: 1200, 2400, 4800, 9600, 19200 and 38400.

The first three transmission speeds are only available via software settings, whereas the last three are available via DIP switches.

Transmission speed [bits/s]	SW4	SW5
9600	OFF	ON
19200	OFF	OFF
38400	ON	OFF
Software-defined	ON	ON

Default transmission speed is 19200 bits per second, as per the Modbus RTU standard.

Software-defined

When SW4 and SW5 are set to "software-defined", writing a value to the holding register at address 00004 will set a new transmission speed.

Use the following values for software-defined transmission speeds:

Software-defined transmission speed	Value to set in register 00004
1200 bits/s	0
2400 bits/s	1
4800 bits/s	2
9600 bits/s	3
19200 bits/s	4
38400 bits/s	5

This value is set to 1200 bits/s as default.

The communication interface does not support transmission speeds above 38400 bits/s.

The software-defined transmission speed value will be stored in the communication interface and will remain after a power-off.

TM04 1697 0908

TM04 1710 0908

5.2 Setting the parity

Note When software-defined transmission speed is enabled (ON), software-defined parity and stop bits are also enabled.

The parity can be set either manually by using SW3 or via software-defined settings.

Manual setting of parity

Default byte format (11 bits):

- 1 start bit
- 8 data bits (least significant bit sent first)
- 1 parity bit (even parity)
- 1 stop bit.

The default setting of the CIM 200 Modbus module is even parity (1 stop bit). It is possible to change the parity using DIP switch SW3. The parity can be changed to no parity (2 stop bits). See fig. 6.

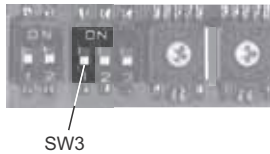

Fig. 6 Parity

DIP switch settings

Parity	SW3
Even parity, 1 stop bit	OFF
No parity, 2 stop bits	ON

Software-defined parity and stop bits

When SW4 and SW5 are set to "software-defined", the value in the holding registers at addresses 00009 and 00010 will override the setting of SW3. See figures 5 and 6.

Software-defined parity	Value to set in register 00009
No parity [default]	0
Even parity	1
Odd parity	2

Software-defined stop bit	Value to set in register 00010
1 stop bit [default]	1
2 stop bits	2

The software-defined parity and stop bit values will be stored in the communication interface and will remain after a power-off.

Note Before the parity and stop bits can be set via software-defined settings, SW4 and SW5 must be set to ON.

5.3 Modbus address selection

A Modbus slave on a Modbus network must have a unique address from 1-247. Address 0 is reserved for broadcasting, and is not a valid slave address.

To set the Modbus address, two hexadecimal rotary switches (SW6 and SW7) are used. See fig. 7.

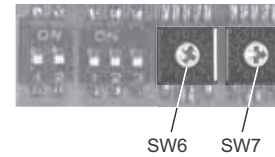

Fig. 7 Setting the Modbus address

For a complete overview of Modbus addresses, see section 13. [Fault finding](#).

Note The Modbus address must be set decimally from 1 to 247.

5.4 Termination resistor

The termination resistor is fitted on the CIM 200 Modbus module and has a value of 150 Ω.

The CIM 200 has a DIP switch with two switches (SW1 and SW2) for cutting the termination resistor in and out. Figure 8 shows the DIP switches in cut-out state.

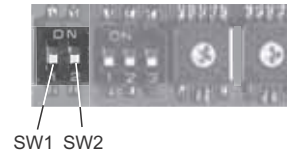

Fig. 8 Cutting the termination resistor in and out

DIP switch settings

Status	SW1	SW2
Cut in	ON	ON
	OFF	OFF
Cut out	ON	OFF
	OFF	ON

Default setting: Termination resistor cut out.

Cable length

We recommend the following maximum lengths:

Bits/s	Maximum cable length	
	Terminated cable [m/ft]	Unterminated cable [m/ft]
1200-9600	1200/4000	1200/4000
19200	1200/4000	500/1700
38400	1200/4000	250/800

Note To ensure a stable and reliable communication, it is important that only the termination resistor of the first and last units in the Modbus network are cut in.

Note All switch settings will be effective immediately after setting the values, no power-off needed.

5.5 Status LEDs

The CIM 200 Modbus module has two LEDs. See fig. 4.

- Red/green status LED (LED1) for Modbus communication
- Red/green status LED (LED2) for internal communication between the CIM 200 and the Grundfos product.

LED1

Status	Description
Off	No Modbus communication.
Flashing green	Modbus communication active.
Flashing red	Fault in the Modbus communication.
Permanently red	Fault in the CIM 200 Modbus configuration.

LED2

Status	Description
Off	The CIM 200 has been switched off.
Flashing red	No internal communication between the CIM 200 and the Grundfos product.
Permanently red	The CIM 200 does not support the Grundfos product connected.
Permanently green	Internal communication between the CIM 200 and the Grundfos product is OK.

Note

During startup, there may be a delay of up to 5seconds before the LED2 status is updated.

6. Modbus GSM/GPRS, CIM 250 setup

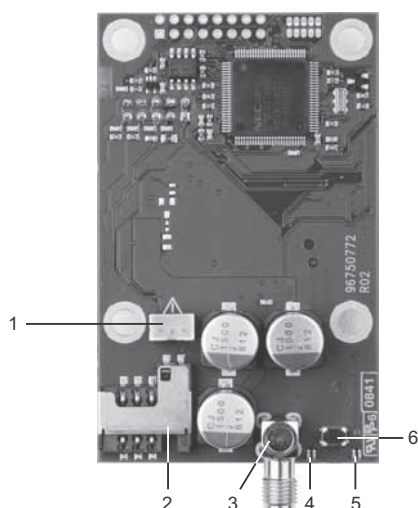

Fig. 9 CIM 250 GSM module (top-side view)

TM04 2642 1210

Pos.	Designation	Description
1		Battery socket
2		SIM card holder
3		SMA connection for GSM antenna
4	LED1	Yellow/green status LED for GSM/GPRS communication
5	LED2	Red/green status LED for internal communication between the CIU 250 and MP 204.
6	SW1	Reset button. Keep the button pressed for 5 seconds to return to default settings.

6.1 Installation

Note

Before installation, make sure that the power supply has been switched off and that it cannot be accidentally switched on.

6.1.1 Fitting a GSM antenna

An antenna must be connected to the CIM 250 to establish connection to the GSM network.

If the CIU 250 is installed in a metal control cabinet, we recommend fitting an external GSM antenna.

Note

Grundfos offers different kinds of antennas. No antenna is supplied with the CIU 250. It must be ordered separately.

External antenna

Connect the antenna cable to the SMA connection (pos. 1) of the CIM 250. The antenna must be installed outside the control cabinet in a position with good reception conditions.

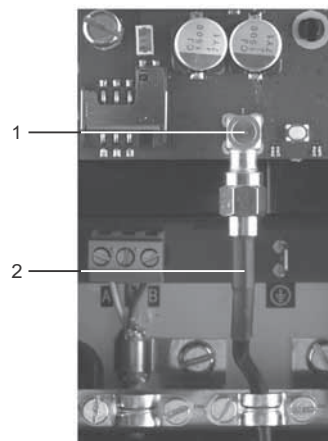

Fig. 10 Fitting an external GSM antenna

TM04 2644 2808

Pos.	Description
1	SMA connection for GSM antenna
2	Antenna cable for external GSM antenna

6.1.2 Inserting the SIM card

Before inserting the SIM card into the CIM 250, remove the PIN code, or set the PIN code to "4321".

Procedure

1. Insert the SIM card into a mobile phone.
2. Remove the PIN code from the SIM card, or set the PIN code to "4321". See the manual of the mobile phone.
3. Insert the SIM card into the CIM 250. See fig. 11.

The slanted edge of the SIM card must point downwards (away from the connector).

Note

The connectors on the SIM card must face inwards towards the CIM 250. See fig. 11.

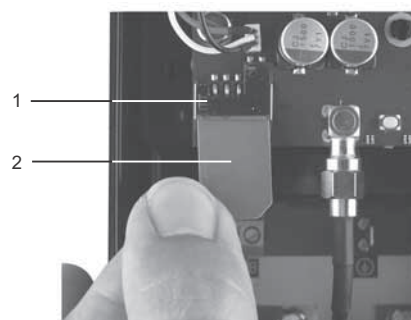

Fig. 11 Inserting the SIM card

TM04 2643 2808

Pos.	Description
1	SIM card holder
2	SIM card

6.1.3 Connecting the battery and power supply



Warning

The CIU 250 must only be connected to SELV or SELV-E circuits.



Warning

The safety precautions listed below must be observed carefully as improper handling of the lithium-ion battery may result in injury or damage from electrolyte leakage, heating ignition or explosion.

These safety precautions must be observed:

- Only insert the approved Grundfos battery pack (97631960).
- Never use this battery pack in other battery chargers.
- Do not dismantle or modify the battery.
- Do not heat or incinerate the battery.
- Do not pierce, crush or cause mechanical damage to the battery.
- Do not short-circuit the battery.
- Do not allow the battery to get wet or be immersed in water.
- Do not strike or throw the battery.
- For long periods of storage, the temperature should be below 45 °C.

The CIM 250 can be fitted with a lithium-ion battery (order no. 97631960), which will ensure sustained GSM/GPRS connection with the product in which it is mounted, even if the power is switched off. The battery is secured by a velcro strap which absorbs vibrations and simplifies replacement. Connect the battery to the CIM 250 as shown in fig. 12.

Note

If a battery is not connected, the user will not receive any SMS alarm message in case of a power cut.

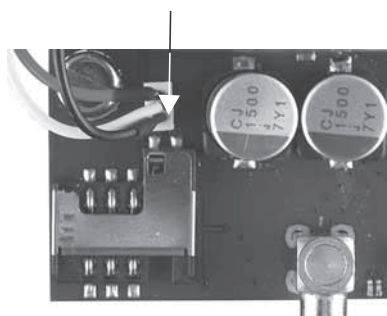

Fig. 12 Connecting the battery

Note

The battery will only be charged if the battery temperature is within 0 °C to +45 °C.

Switch on the power supply. The CIM 250 is powered either by the CIU 250 or by the battery.

The LED1 flashes yellow (searching for GSM network). When the connection to the GSM network has been established, the LED1 will pulsate yellow (GSM network active). See fig. 13.

The LED2 must be constantly green, indicating that the CIM 250 has been fitted correctly in the CIU 250.

6.1.4 Configuration

For software configuration of the CIU 250, which includes setting of SMS functions and SCADA communication parameters, see "CIM 250 SMS commands" (supplement to the installation and operating instructions) on the CD-ROM supplied with the GSM module.

6.2 Status LEDs

The CIM 250 GSM module has two LEDs. See fig. 9.

- Yellow/green status LED (LED1) for GSM/GPRS communication.

Red/green status LED (LED2) for internal communication between the CIM 250 and the MP 204.

LED1 (yellow/green)

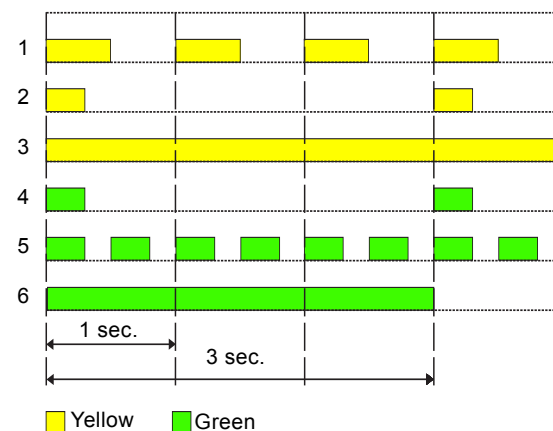

Fig. 13 LED1 status

Pos.	Status	Description
1	Flashing yellow	Searching for GSM network.
2	Pulsating yellow (single pulse)	Connection to the GSM network has been established.
3	Constantly yellow	Call-up connection has been established.
4	Pulsating green (single pulse)	Data are exchanged via GPRS.
5	Pulsating green (double pulse)	Data are exchanged via the call-up connection.
6	Green (3 sec.)	Sending or receiving an SMS message.

LED2 (red/green)

Status	Description
Off	The CIM 250 has been switched off.
Flashing red	No communication between the CIM 250 and the MP 204.
Constantly red	The CIM 250 does not support the connected version of the MP 204.
Constantly green	The connection between the CIM 250 and the MP 204 is OK.

TM04 2645 2808

TM04 5194 4412

7. Modbus TCP, CIM 500 setup



Warning

The CIU 500 must only be connected to SELV or SELV-E circuits.

7.1 Connecting the Ethernet cable

RJ45 plugs and Ethernet cable must be used. The cable shield must be connected to protective earth at both ends.

Note

It is important to connect cable shield to earth through earth clamp or to connect cable shield to earth in the connector.

The CIM 500 is designed for flexible network installation; the built-in two port switch makes it possible to daisy chain from product to product without the need of additional Ethernet switches. The last product in the chain is only connected to one of the Ethernet ports. Each Ethernet port has its own MAC address.

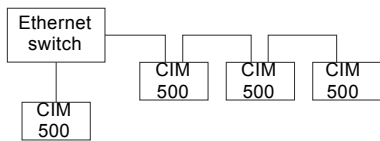

Fig. 14 Example of Industrial Ethernet network

TM05 6435 4711

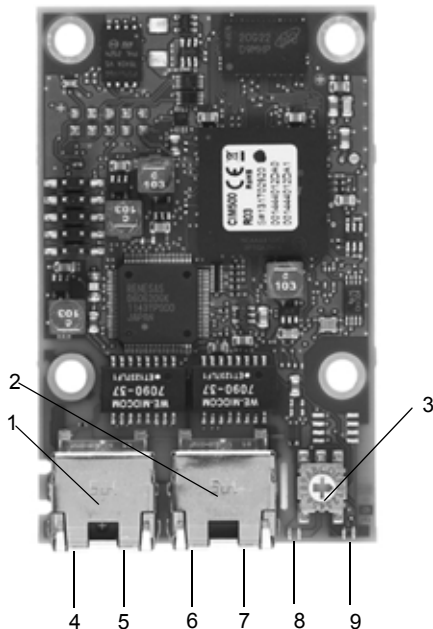

Fig. 15 Example of Ethernet connection

TM05 7431 1013

Pos.	Description	Designation
1	Industrial Ethernet RJ45 connector 1	ETH1
2	Industrial Ethernet RJ45 connector 2	ETH2
3	Rotary switch for protocol selection	SW1
4	Data activity LED for connector 1	DATA1
5	Link LED for connector 1	LINK1
6	Data activity LED for connector 2	DATA2
7	Link LED for connector 2	LINK2
8	Green/red status LED for Ethernet communication	LED 1
9	Green/red status LED for internal communication between module and MP 204.	LED 2

7.2 Setting the Industrial Ethernet protocol

The CIM 500 Ethernet module has a rotary switch for selection of the Industrial Ethernet protocol. See fig. 16.



Fig. 16 Selecting the Industrial Ethernet protocol

TM05 7431 1013

Pos.	Description
0	PROFINET IO (default from factory)
1	Modbus TCP
2..E	Reserved, LED1 will be permanently red to indicate an invalid configuration Reset to factory default Note: The rotary switch has to be set in this position for 20 seconds to Reset to factory default. During this period LED1 will be flashing red and green at the same time to indicate reset will occur.
F	

Note Every change of the rotary switch setting, when the module is powered on, will cause the module to restart.

7.3 Setting up the IP addresses

The CIM 500 Ethernet module is default set up to a fixed IP address. It is possible to change the IP address settings from the built in web server.

Default IP settings used by web server	IP address: 192.168.1.100 Subnet mask: 255.255.255.0 Gateway: 192.168.1.1
IP settings for Modbus TCP	Must be set up by the Web server

7.4 Establish connection to the Web server

The CIM 500 module can be configured using the built-in Web server. To establish a connection from a PC to CIM 500 the following steps are required:

- Connect the PC and the CIM 500 module using an Ethernet cable
- Configure the PC Ethernet port to the same subnetwork as the CIM 500, e.g. 192.168.1.101, and the subnet mask to 255.255.255.0. See section [A.1 How to configure an IP address on your PC](#) on page 43.
- Open a standard Internet browser and type 192.168.1.100 in the URL field.
- Log in to the Web server using:

User	admin (default)
Password	Grundfos (default)

Note *User and password may have been changed from their factory default values.*



Fig. 17 CIM 500 connected to PC via Ethernet cable

For further information how to use the Web server, see section [A.2 Web server configuration](#) on page 43.

Note *Both ETH1 and ETH2 can be used to establish a connection to the Web server.*

Note *The web server can be accessed while the selected Industrial Ethernet protocol is active.*

TM05 6436 4712

7.5 Status LEDs

The CIM 500 Ethernet module has two status LEDs, (LED1 and LED2). See fig. 15.

- Red/green status LED (LED1) for Ethernet communication
- Red/green status LED (LED2) for internal communication between the CIM 500 and the Grundfos product.

LED1

Status	Description
Off	No Modbus TCP communication or switched off.
Flashing green	Modbus TCP communication active.
Permanently red	CIM 500 module configuration fault. See section 13.3.1 LED status .
Permanently red and green	Error in firmware download. See section 13.3.1 LED status .
Flashing red and green	Resetting to factory default. After 20 seconds the CIM 500 will restart.

LED2

Status	Description
Off	The CIM 500 is switched off.
Flashing red	No internal communication between the CIM 500 and the Grundfos product.
Permanently red	The CIM 500 does not support the Grundfos product connected.
Permanently green	Internal communication between the CIM 500 and the Grundfos product is OK.
Permanently red and green	Memory fault.

Note *During startup, there is a delay of up to 5 seconds before LED1 and LED2 status is updated.*

7.6 DATA and LINK LEDs

The CIM 500 Ethernet module has two connectivity LEDs related to each RJ45 connector. See fig. 15.

DATA1 and DATA2

These yellow LEDs indicate data traffic activity.

Status	Description
Yellow off	No data communication on RJ45 connector.
Yellow flashing	Data communication ongoing on RJ45 connector.
Steady yellow	Heavy network traffic on RJ45 connector.

LINK1 and LINK2

These green LEDs shows whether the ethernet cable is properly connected.

Status	Description
Green off	No Ethernet Link on RJ45 connector
Green on	Ethernet Link on RJ45 connector is OK

8. Modbus function code overview

The supported function codes are shown in the table below:

Type	Code	Hex	Name
16-bit data (registers)	03	0x03	Read holding registers
	04	0x04	Read input registers
	06	0x06	Write single register
	16	0x10	Write multiple registers
Diagnostics	08	08	Diagnostics See section 12.6 Diagnostics (0x08) for subcodes.

Note *Reading or writing coils are not supported.*

The same data are available in both holding registers and input registers, meaning that either function (0x03 or 0x04) can be used for reading data.

9. Modbus register overview

9.1 Register block overview

The Modbus RTU registers are grouped in the following register blocks:

Start address	Register block	Permissions	Description
00001	CIM configuration	R/W	Configuration of the CIM module.
00021	CIM status	R	Status registers for the CIM module.
00101	MP 204 control	R/W	Registers for control of the MP 204.
00201	MP 204 status	R	Registers for status from the MP 204.
00301	MP 204 data	R	Registers for measured data values from the MP 204.
00701	Alarm simulation	R/W	Registers for simulation of alarms and warnings.
00751-00800	User registers	R/W	The CIU will not modify this area by itself.

All addresses contain registers. Some are bit-interpreted while others are 16-bit values, or high/low order parts of 32-bit values. A data value of 65535 (0xFFFF) indicates "not available" when reading registers. The value of 65535 (0xFFFF) does not imply a "disable" when writing values.

Each register block will be specified in more detail in the following sections.

9.2 CIM configuration register block

Registers in this block can be read by means of function codes 0x03 and/or 0x04. They can be written as holding registers with function codes 0x06 and 0x10.

Address	Register name	Description	CIM 200	CIM 250	CIM 500
00001	SlaveMinimumReplyDelay	The minimum reply delay from the slave in ms. Value range: 0-10000, i.e. up to 10 seconds reply delay. This delay is typically used in conjunction with a radio modem. The delay value is stored in the device and will remain after a power-off. The delay set here will be added to the internal delay in the device. Default value is 0.	•	-	-
00002	RegisterOffset	An address offset that is added to all addresses above 00100. Default value is 0. Note: This offset does not affect the CIM configuration register block or the CIM status register block addresses. The register offset value is stored in the device and will remain after a power-off. For most applications, this offset should not be changed.	•	•	•
00003	SoftwareDefinedModbusAddress	This register holds the active Modbus address. The default value is 0xE7 (231), and there is normally no need to change this value. Note: For CIM 200 this value is used only when the transmission speed is set to "Software-defined" on the DIP switches SW4 and SW5 by selecting a value outside the range [0; 247]. Otherwise, it will be ignored by the slave.	•	•	•
00004	SoftwareDefinedBitRate	Modbus software-defined transmission speed enumeration. The software-defined transmission speed value is stored in the device and will remain after a power-off. 0: 1200 bits/s 1: 2400 bits/s 2: 4800 bits/s 3: 9600 bits/s 4: 19200 bits/s 5: 38400 bits/s. Note: This value is used only when the transmission speed is set to "Software-defined" on the DIP switches SW4 and SW5. Otherwise, it will be ignored by the slave.	•	-	-
00005	AutoAckControlBits	Used to select the behaviour of control bit acknowledgements from the CIU. 0: Disabled. Control bits are not automatically lowered when accepted by the device. The user must lower the triggered control bit manually before the control bit can be triggered again. 1: Enabled. Control bits are automatically lowered when accepted by the device. The user does not have to lower it manually [default].	•	•	•
00006	ReadWriteSeparation	Not used.	-	-	-
00007	ScadaCallBackRegister	Not used.	-	-	-
00008	NoDataActivityTimeout	The elapsed time with no data activity before the module issues a "GPRS restart".	-	•	-
00009	SoftwareDefinedParity	Parity setting to be used when using "software-defined" settings. 0: No parity [default] 1: Even parity 2: Odd parity. Note: For CIM 200 this value is used only when the transmission speed is set to "Software-defined" on the DIP switches SW4 and SW5. Otherwise, it will be ignored by the slave.	•	-	-
00010	SoftwareDefinedStopBit	Stop bit setting to be used when using "software-defined" settings. 0: No stop bit 1: 1 stop bit [default] 2: 2 stop bits. Note: For CIM 200 this value is used only when the transmission speed is set to "Software-defined" on the DIP switches SW4 and SW5. Otherwise, it will be ignored by the slave.	•	-	-

9.3 CIM status register block

Registers in this block can be read by means of function codes 0x03 and/or 0x04. They are read-only. This block can be used for various kinds of fault finding.

Address	Register name	Description	CIM 200	CIM 250	CIM 500
00021	GENIbusCRCErrorCnt	Holds a CRC error counter for the GENIbus connection between the CIU and the MP 204.	•	•	•
00022	GENIbusDataErrorCnt	Holds a CRC error counter for the GENIbus connection between the CIU and the MP 204.	•	•	•
00023	VersionNumber	A Grundfos-specific version number. This is an unsigned integer value.	•	•	•
00024	ActualModbusAddress	Holds the current Modbus slave address of the device. Valid value range: 1...247.	•	•	•
00025	GENIbusTXcountHI	Holds a transmit counter for total number of telegrams sent to the MP 204 on the GENIbus connection.	•	•	•
00026	GENIbusTXcountLO				
00027	GENIbusRXcountHI	Holds a receive counter for total number of telegrams received from the MP 204 on the GENIbus connection.	•	•	•
00028	GENIbusRXcountLO				
00029	GeneralStatus Bit 0: ScadaPinCodeEnabled	PIN code functionality. 0: No PIN code required 1: PIN code required to perform remote control and configuration. Activation of SCADA PIN code protection takes place via the SMS command SCADACODE. See "CIM 250 SMS commands" (supplement to installation and operating instructions) on the CD-ROM supplied with the GSM module.	-	•	-
	GeneralStatus Bit 1: WriteAccess	Remote write access. 0: No write access (the PIN code is incorrect). 1: Full write access (the PIN code is either correct or not enabled).	-	-	-
00030	UnitFamily	Grundfos product family.	•	•	•
00031	UnitType	Grundfos product type.	•	•	•
00032	UnitVersion	Grundfos product version.	•	•	•
00033	GSMBatteryState	State of GSM battery 0: Battery not present 1: Battery must be replaced 2: Battery charging 3: Battery needs charging, but temperature too high 4: Battery needs charging, but temperature too low 5: Battery low 6: Battery OK 255: Battery state not available	-	•	-

9.4 GSM real time clock

Address	Register name	Description	CIM 200	CIM 250	CIM 500
00080	SetUNIXRealTimeClockHI	Set real time clock (32 bit UNIX format)	-	•	-
00081	SetUNIXRealTimeClockLO	Triggered on value change	-	•	-
00082	SetRtcSecond	Set real time clock (seconds)	-	•	-
00083	SetRtcMinute	Set real time clock (minutes)	-	•	-
00084	SetRtcHour	Set real time clock (hours)	-	•	-
00085	SetRtcDay	Set real time clock (day)	-	•	-
00086	SetRtcMonth	Set real time clock (month)	-	•	-
00087	SetRtcYear	Set real time clock (year)	-	•	-
00088	Bit 0: SetRtc	Triggers setting of real time clock (s/m/h/d/m/y format)	-	•	-
00089	StatusUNIXRealTimeClockHI	Real time clock (32 bit UNIX format)	-	•	-
00090	StatusUNIXRealTimeClockLO				
00091	StatusRtcSecond	Real time clock - seconds	-	•	-
00092	StatusRtcMinute	Real time clock - minutes	-	•	-
00093	StatusRtcHour	Real time clock - hours	-	•	-
00094	StatusRtcDay	Real time clock - day of month	-	•	-
00095	StatusRtcMonth	Real time clock - month	-	•	-
00096	StatusRtcYear	Real time clock - year (after 2000)	-	•	-
00097	Bit 0: StatusSetRTCAck	Acknowledge of set RTC command	-	•	-

9.5 MP 204 control register block

Registers in this block can be read by means of function codes 0x03 and/or 0x04. They can be written as holding registers with function codes 0x06 and 0x10. The MP 204 will react to its last received command, no matter whether this command was triggered via Modbus, with a remote control or on the MP 204 operator buttons.

Address	Register name	Description
00101	ControlRegister Bit 0: ResetAlarm	Control bit that resets alarms and warnings. 0 = No resetting 1 = Resetting alarm. This control bit is triggered on rising edge only, i.e. setting logical 0 to 1. See section 9.2 CIM configuration register block , address 00005, for acknowledgement behaviour.
	ControlRegister Bit 1: CommandedTrip	Control bit that command-trips the MP 204. Status is obtained from OperatingMode (register 00202). 0 = No trip 1 = Trip. This control bit is triggered on rising edge only, i.e. setting logical 0 to 1. See section 9.2 CIM configuration register block , address 00005, for acknowledgement behaviour.
	ControlRegister Bit 2: OnOffReq	Control bit that switches the pump on and off. Status is obtained from OperatingMode (register 00202). 0 = Off (stop) 1 = On (start).
	ControlRegister Bit 3: ProtectionEnabled	Control bit that enables/disables the general protection. Status is obtained from StatusRegister (register 00201, bit 1). 0 = Protection disabled 1 = Protection enabled.
	ControlRegister Bit 5: ResetStartCounter	Control bit that resets the NumberOfStartsTripCounterHI/LO (registers 00342 and 00343). 0 = No resetting 1 = Resetting. This control bit is triggered on rising edge only, i.e. setting logical 0 to 1. See section 9.2 CIM configuration register block , address 00005, for acknowledgement behaviour.
	ControlRegister Bit 6: ResetRestartCounter	Control bit that resets the AutoRestartsTripCounterHI/LO (registers 00344 and 00345). 0 = No resetting 1 = Resetting. This control bit is triggered on rising edge only, i.e. setting logical 0 to 1. See section 9.2 CIM configuration register block , address 00005, for acknowledgement behaviour.
	ControlRegister Bit 7: ResetLogs	Control bit that resets the maximum/minimum voltage and current logs and maximum number of starts per hour log (registers 00348, 00349, 00350, 00351 and 00352). 0 = No resetting 1 = Resetting. This control bit is triggered on rising edge only, i.e. setting logical 0 to 1. See section 9.2 CIM configuration register block , address 00005, for acknowledgement behaviour.
	ControlRegister Bit 8: ResetHourCounter	Control bit that resets the OperationTimeTripCounterHI/LO (registers 00338 and 00339). 0 = No resetting 1 = Resetting. This control bit is triggered on rising edge only, i.e. setting logical 0 to 1. See section 9.2 CIM configuration register block , address 00005, for acknowledgement behaviour.
	ControlRegister Bit 9: ResetEnergyCounter	Control bit that resets the EnergyTripCounterHI/LO (registers 00332 and 00333). 0 = No resetting 1 = Resetting. This control bit is triggered on rising edge only, i.e. setting logical 0 to 1. See section 9.2 CIM configuration register block , address 00005, for acknowledgement behaviour.

9.6 MP 204 status register block

Registers in this register block can be read by means of function codes 0x03 and/or 0x04. They are read-only.

Address	Register name	Description
00201	StatusRegister Bit 0: Rotation	Indicates if the pump is rotating (consuming power) or not. 0 = No rotation 1 = Rotation.
	StatusRegister Bit 1: ProtectionEnabled	Indicates if the general protection is enabled or disabled. 0 = Protection disabled 1 = Protection enabled. Protection can be enabled/disabled with ControlRegister (register 00101, bit 3).
	StatusRegister Bit 2: Ready	Indicates if the MP 204 is ready or not. 0 = Not ready 1 = Ready.
	StatusRegister Bit 3: Unacknowledged fault	Indicates if an unacknowledged fault is pending 0 = No unacknowledged fault 1 = Unacknowledged fault pending
	StatusRegister Bit 4: PTC	Indicates status of the PTC. 0 = Closed 1 = Open.
	StatusRegister Bit 5: PhaseSequence	Indicates the actual phase sequence. 0 = Phase sequence is right: L1-L2-L3 1 = Phase sequence is left: L3-L2-L1.
00202	OperatingMode	Indicates the actual operating mode. See fig. 18. 0 = Started (on, normal condition) This is the normal mode when the motor is running without alarms (warnings may be present). The R1 motor relay is closed, the R2 alarm relay is open and the red "Trip" indicator light on the MP 204 is off.
		1 = Commanded trip (result of control register 00101, bit 1) This mode is the result of the CommandedTrip or of pressing the [T] button. The alarm code "18" is shown in the display. The behaviour is equal to ++ MotorProtectionTrip.
		2 = Actuator stop (off) (result of control register 00101, bit 2) This mode is the result of the state control bit OnOffReq = 0. The motor will be switched off, and the MP 204 display will show "OFF". 3 = Protection stop. The MP 204 has detected an alarm condition and has switched the motor off. Data module AlarmCode will contain the related code for the alarm condition. This code is also shown in the display. The R1 motor relay is open, the R2 alarm relay is closed and the red "Trip" indicator light on the MP 204 is on.
00203	SystemMode	Indicates the actual system mode. 0 = Power-up. In this mode, the MP 204 is powering up, and the "Power" indicator light will be flashing green. A power-on delay [1-254s] can be programmed with the R100 to prolong this period. After power-up, the MP 204 automatically enters the system mode "Operation".
		1 = Operating (normal condition). The normal system mode. 2 = MP 204 fault. The MP 204 has a hardware fault. Power-off is required to attempt restarting. It may be necessary to replace the MP 204.
00204	AlarmCode	The Grundfos-specific alarm code. See section 9.7 Alarm code module register 00204 .
00205	WarningBits1	Bit-interpreted warnings. See section 9.8 Warning bits registers 00205 and 00206 .
00206	WarningBits2	
00207	Relays Bit 0: ControlRelay	Indicates the status of the motor control relay. 0 = Relay opened 1 = Relay closed (power-on default after timeout).
	Relays Bit 1: SignalRelay	Indicates the status of the alarm signal relay. 0 = Relay opened (power-on default) 1 = Relay closed.

Address	Register name	Description	
00208	AcknowledgeRegister Bit 0: ResetAlarmAck	Indicates if a ResetAlarm control bit was acknowledged by the device. 0 = No acknowledgement 1 = Control bit acknowledged. This functionality is only used when AutoAckControlBits is disabled. See section 9.2 CIM configuration register block , address 00005.	
	AcknowledgeRegister Bit 1: TripAck	Indicates if a commanded-trip control bit was acknowledged by the device. 0 = No acknowledgement 1 = Control bit acknowledged. This functionality is only used when AutoAckControlBits is disabled. See section 9.2 CIM configuration register block , address 00005.	
	AcknowledgeRegister Bits 2-4: RESERVED	-	
	AcknowledgeRegister Bit 5: ResetStartCounterAck	Indicates if a ResetStartCounter control bit was acknowledged by the device. 0 = No acknowledgement 1 = Control bit acknowledged. This functionality is only used when AutoAckControlBits is disabled. See section 9.2 CIM configuration register block , address 00005.	
	AcknowledgeRegister Bit 6: ResetRestartCounterAck	Indicates if a ResetRestartCounter control bit was acknowledged by the device. 0 = No acknowledgement 1 = Control bit acknowledged. This functionality is only used when AutoAckControlBits is disabled. See section 9.2 CIM configuration register block , address 00005.	
	AcknowledgeRegister Bit 7: ResetLogsAck	Indicates if a ResetLogs control bit was acknowledged by the device. 0 = No acknowledgement 1 = Control bit acknowledged. This functionality is only used when AutoAckControlBits is disabled. See section 9.2 CIM configuration register block , address 00005.	
	AcknowledgeRegister Bit 8: ResetHourCounterAck	Indicates if a ResetHourCounter control bit was acknowledged by the device. 0 = No acknowledgement 1 = Control bit acknowledged. This functionality is only used when AutoAckControlBits is disabled. See section 9.2 CIM configuration register block , address 00005.	
	AcknowledgeRegister Bit 9: ResetEnergyCounterAck	Indicates if a ResetEnergyCounter control bit was acknowledged by the device. 0 = No acknowledgement 1 = Control bit acknowledged. This functionality is only used when AutoAckControlBits is disabled. See section 9.2 CIM configuration register block , address 00005.	
	00236	GSMSignalLevelActual	Actual level of GSM signal. (CIU 250 only)
	00237	GSMSignalLevelAverage	Average level of GSM signal. (CIU 250 only)
00238	IPAddressHI	IP address for GPRS communication. (CIU 250 only)	
00239	IPAddressLO		

Operating mode

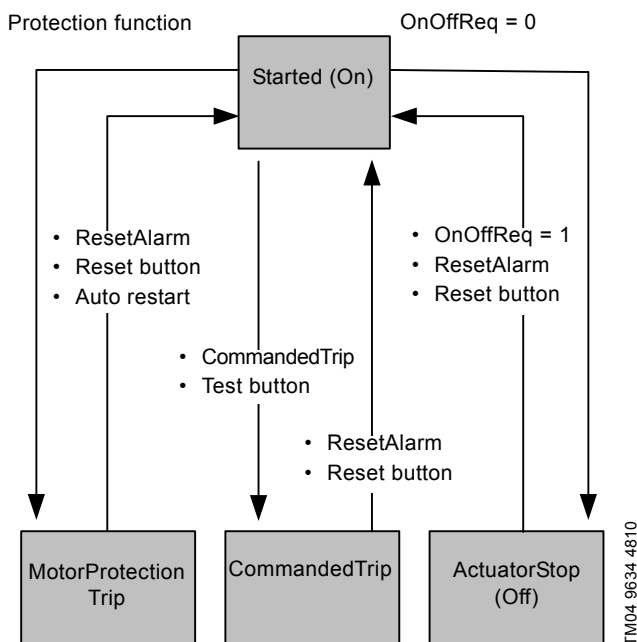

Fig. 18 Operating mode state event diagram

9.7 Alarm code module register 00204

In the AlarmCode register, the cause of a motor protection trip can be read in the form of an alarm code. The complete list of alarm codes supported by the MP 204 is shown below.

Note that a few of the alarm codes are warnings only (W).

They are included in the table for the sake of completeness.

They can never appear in the AlarmCode register, but only in the WarningBits registers described in section [9.8 Warning bits registers 00205 and 00206](#).

Code	Alarm/warning description	A/W	Trip delay	3-phase	1-phase	Auto restart after alarm	Programmable limit
2	Missing phase	A	-	●	-	Condition + delay	Enabled
3	External alarm signal (PTC)	A	-	●	●	Condition + delay	E/D
4	Too many automatic restarts per 24 hours	A	-	●	●	Reset required	E/D + value
9	Phase sequence reversal	A	-	●	-	Condition + delay	Enabled
12	Service warning	W	-	●	●	-	Value
15	Communication alarm, main system	A	-	●	●	Condition + delay	Disabled
18	Test trip (control module TestTrip) not in alarm log	A	-	●	●	Reset required	-
20	Insulation resistance low	A + W	●	●	-	Condition + delay	E/D + value
21	Too many starts per hour	W	-	●	●	Condition	Enabled
26	Load continues even if motor relay R1 is off	W	-	●	●	Condition	Enabled
32	Overvoltage	A + W	●	●	●	Condition + delay	Value
40	Undervoltage	A + W	●	●	●	Condition + delay	Value
48	Overload (current too high)	A + W	IEC	●	●	Delay	Value
56	Underload (current too low)	A + W	●	●	●	Delay	Value
64	Overtemperature, Tempcon measurement	A + W	●	●	-	Condition + delay	E/D + value
71	Overtemperature, Pt100 measurement	A + W	●	●	●	Condition + delay	E/D + value
91	Signal fault, Tempcon sensor	W	●	●	●	-	E/D
111	Current asymmetry	A + W	●	●	-	Delay	Value
112	Cos(φ) too high	A + W	●	●	●	Delay	Value
113	Cos(φ) too low	A + W	●	●	●	Delay	Value
120	Auxiliary winding alarm	A	●	-	●	Delay	Enabled
123	Start capacitor, low	A + W	●	-	●	Delay	Value
124	Run capacitor, low	A + W	●	-	●	Delay	Value
175	Signal fault, Pt100 temperature sensor	W	●	●	●	-	E/D

Explanation to the alarm code table

Text	Description
A/W	Alarm (A), warning (W) or alarm and warning (A + W).
Trip delay	Delay between the appearance of an alarm until the MP 204 switches the motor off. This delay, which is common to all the bullet-marked alarms, can be programmed with the R100 remote control. Alarms without Trip delay result in immediate reaction. Tripping due to overload is based on IEC standard trip curves.
1-phase/3-phase	Type of motor.
Auto restart	
• Condition	This means that the conditions for the alarm must have disappeared before a restart is possible.
• Delay	This means that restarting is delayed with the common restart delay which is programmable with the R100 remote control.
Programmable limit	
• Enabled	This protection is always enabled. It can only be disabled with a special programming tool.
• Disabled	This protection is always disabled. It can only be enabled with a special programming tool.
• E/D	Can be enabled/disabled with the R100 remote control.
• Value	Value of protection limit can be programmed with the R100 remote control.

9.8 Warning bits registers 00205 and 00206

The WarningBits registers show all actual warning conditions, one bit for each. Contrary to alarms, there can be many simultaneous warnings present. The complete list of warning bits and their equivalent codes are shown below.

	Bit	Bit name	Equivalent code	3-phase	1-phase	Programmable limit
WarningBits1 00205	0	Overvoltage	32	•	•	Value
	1	Undervoltage	40	•	•	Value
	2	Overload (current too high)	48	•	•	Value
	3	Underload (current too low)	56	•	•	Value
	4	Current asymmetry	111	•	-	Value
	5-7	-	-	-	-	-
	8	Insulation resistance low	20	•	-	E/D + value
	9	Overtemperature, Tempcon measurement	64	•	-	E/D + value
	10	Overtemperature, Pt100 measurement	71	•	•	E/D + value
	11	-	-	-	-	-
	12	Cos(φ) too high	112	•	•	Value
	13	Cos(φ) too low	113	•	•	Value
	14	Too many starts per hour	21	•	•	Enabled
	15	-	-	-	-	-
	WarningBits2 00206	0	Start capacitor, low	123	-	•
1		Run capacitor, low	124	-	•	Value
2		-	-	-	-	-
3		Signal fault, Tempcon sensor	91	•	-	E/D
4		Signal fault, Pt100 temperature sensor	175	•	•	E/D
5		Service warning	12	•	•	Enabled
6		Load continues even if motor relay R1 is off	26	•	•	Enabled
	7-15	-	-	-	-	

9.9 MP 204 data register block

Registers in this block can be read by means of function codes 0x03 and/or 0x04. They are read-only. The table below shows the availability of the data, depending on system configuration.

Unless otherwise stated, the data type used for counters and scaled values is always an unsigned integer.

Address	Register name	Scale	Notes	1-phase	3-phase
00301	PhaseVoltageL1	0.1 V		Reference voltage (= 0)	L1 phase voltage
00302	PhaseVoltageL2	0.1 V		Phase voltage	L2 phase voltage
00303	PhaseVoltageL3	0.1 V		Auxiliary winding voltage	L3 phase voltage
00304	PhaseVoltageMean	0.1 V		Phase voltage	Mean of phase voltages L1, L2 and L3
00305	LineVoltageL1L2	0.1 V		-	L1-L2 line voltage
00306	LineVoltageL2L3	0.1 V		-	L2-L3 line voltage
00307	LineVoltageL3L1	0.1 V		-	L3-L1 line voltage
00308	LineVoltageMean	0.1 V		-	Mean of line voltages L1-L2, L2-L3 and L3-L1
00309	LineCurrentL1	0.1 A		Neutral current	L1 line current
00310	LineCurrentL2	0.1 A		Mains winding current	L2 line current
00311	LineCurrentL3	0.1 A		Auxiliary winding current	L3 line current
00312	LineCurrentMean	0.1 A		Line current (= neutral current)	Mean value of line currents L1, L2 and L3
00313	LineCurrentStart	0.1 A		Peak line current from the latest motor start	Peak line current from the latest motor start
00314	MotorTemp1	0.01 K		Motor temperature measured by Tempcon	Motor temperature measured by Tempcon
00315	MotorTemp2	0.01 K		Motor temperature measured by PT resistor	Motor temperature measured by PT resistor
00316	LineCurrentAsym	0.1 %		-	Line current asymmetry
00317	CapacitorStart	1 μ F		Start capacitor value	-
00318	CapacitorRun	1 μ F		Run capacitor value	-
00319	CapacitorStartRef	1 μ F		Start capacitor reference value	-
00320	CapacitorRunRef	1 μ F		Run capacitor reference value	-
00321	LineFrequency	0.1 Hz		Line frequency	Line frequency
00322	VoltageAngleL1L2	1 degree		-	Voltage angle L1-L2
00323	VoltageAngleL1L3	1 degree		-	Voltage angle L2-L3
00324	CosPhiL1	0.01		-	L1 current phase angle cosine
00325	CosPhiL2	0.01		-	L2 current phase angle cosine
00326	CosPhiL3	0.01		-	L3 current phase angle cosine
00327	CosPhi	0.01		Mean phase angle cosine (power factor)	Mean phase angle cosine (power factor)
00328	PowerHI	1 W		Power consumption	Power consumption
00329	PowerLO				
00330	EnergyHI	1 kWh		Energy consumption	Energy consumption
00331	EnergyLO				
00332	EnergyTripCounterHI	1 kWh	Reset with ControlRegister (register 00101, bit 9).	Energy consumption trip counter (resettable)	Energy consumption trip counter (resettable)
00333	EnergyTripCounterLO				
00334	OperationTimeHI	1 hour		Operating time	Operating time
00335	OperationTimeLO				
00336	TotalPoweredTimeHI	1 hour		Total powered time	Total powered time
00337	TotalPoweredTimeLO				
00338	OperationTimeTripCounterHI	1 hour	Reset with ControlRegister (register 00101, bit 8).	Operating time trip counter (resettable)	Operating time trip counter (resettable)
00339	OperationTimeTripCounterLO				
00340	NumberOfStartsHI	Unscaled		Number of starts counter	Number of starts counter
00341	NumberOfStartsLO				

Address	Register name	Scale	Notes	1-phase	3-phase
00342 00343	NumberOfStartsTripCounterHI NumberOfStartsTripCounterLO	Unscaled	Reset with ControlRegister (register 00101, bit 5).	Number of starts trip counter (resettable)	Number of starts trip counter (resettable)
00344 00345	AutoRestartsTripCounterHI AutoRestartsTripCounterLO	Unscaled	Reset with ControlRegister (register 00101, bit 6).	Auto-restarts trip counter (resettable)	Auto-restarts trip counter (resettable)
00346	InsulationResistance	10 kΩ		-	Insulation resistance
00347	PhaseVoltageDistortion	0.01 %		Phase voltage distortion	Phase voltage distortion
00348	VoltageMaxLog	0.1 V		Logged maximum value of line voltage	Logged maximum value of line voltage
00349	VoltageMinLog	0.1 V		Logged minimum value of line voltage	Logged minimum value of line voltage
00350	CurrentLineMaxLog	0.1 A	Reset with ControlRegister (register 00101, bit 7).	Logged maximum value of line current	Logged maximum value of line current
00351	CurrentLineMinLog	0.1 A		Logged minimum value of line current	Logged minimum value of line current
00352	StartsHourMaxLog	Unscaled		Logged maximum value of starts per hour	Logged maximum value of starts per hour
00353	StartsPerHour	Unscaled		Starts per hour (moving average)	Starts per hour (moving average)
00354	AutoRestartsPer24h	Unscaled		Auto restarts per hour (moving average)	Auto restarts per hour (moving average)

9.10 Alarm simulation register block

Registers in this register block can be read by means of function codes 0x03 and/or 0x04.

Address	Register name	Description
00701	SimulationWarningBits1	Used to generate simulated alarms/warnings.
00702	SimulationWarningBits2	Simulated alarms and warnings can be cleared with the ResetAlarm control bit (register 00101, bit 0) or by pressing the "R" button on the MP 204. Bit interpretation like
00703	SimulationAlarmBits1	WarningBits1 (register 00205) and WarningBits2 (register 00206).
00704	SimulationAlarmBits2	

9.11 User register block

Address	Register name	Scale	Description
00751-00800	UserRegisters	Unscaled	This area is for device labelling by the user (SCADA system). The CIU will not modify this area by itself. The user register values are stored in the CIU device and will remain after a power-off.

10. Modbus RTU commissioning, step-by-step guides

Note If the sensor configuration is changed, restart the CIU unit to ensure a correct scaling of the sensor value.

10.1 Hardware setup (CIU 200)

Step	Action
1	Complete the MP 204 configuration. This can be done either via the R100 or Grundfos GO remote control or Grundfos PC Tool E-Products.
2	Select the Modbus slave address (1-247).
3	Select the transmission speed of the Modbus slave.
4	Select parity and stop bits of the Modbus slave (even parity with 1 stop bit or no parity with 2 stop bits).
5	If necessary, set line termination.
6	Connect the GENIbus cable from the CIU 200 to the MP 204.
7	Connect the necessary cables from the CIU 200 to the Modbus network.
8	Connect the power supply cable to the CIU 200, and switch the unit on.
9	Confirm that the GENIbus LED is constantly green and that the Modbus LED is either off (if no master is actively polling the slave) or flashing green (indicating error-free communication).

The CIU 200 is now ready to be accessed via the Modbus network.

10.2 Hardware setup (CIU 250 GSM call-up)

Step	Action
1	Connect the GENIbus cable from the CIU 250 to the Grundfos product (see figure 5 in the "CIU, Communication Interface Unit installation and operating instructions").
2	Fit a GSM antenna to the CIM module SMA connector (see section 6.1.1 Fitting a GSM antenna).
3	Insert the SIM card in the CIM 250 (see section 6.1.2 Inserting the SIM card).
4	Connect the mains cable to the CIU 250 (see the CIU quick guide instruction) and power on the CIU 250.
5	Power on the Grundfos product
6	Observe that LED2 turns steady green (see section 6.2 Status LEDs), indicating that the GENIbus connection is working.
7	Observe that LED1 blinks yellow and changes to yellow pulsing after approximately 30 s (see section 6.2 Status LEDs), indicating that the GSM connection is working. By making a call-up from a phone the connection can be verified (LED1 turns steady yellow).
8	For configuring the CIU 250 for a call-up connection, follow the instructions in the "CIM 250 SMS commands installation and operating instructions" (included on CIM/CIU support files CD), section 2.1-3.
9	To verify the GSM settings after completion, the SMS command GSMSETTINGS can be used.

The CIU 250 is now ready to be accessed from a Modbus RTU master via GSM call-up (or via SMS commands).

10.3 Hardware setup (CIU 250 GPRS connection)

Step	Action
1	Connect the GENIbus cable from the CIU 250 to the Grundfos product (see the CIU quick guide instruction).
2	Fit a GSM antenna to the CIM module SMA connector (see section 6.1.1 Fitting a GSM antenna).
3	Insert the SIM card in the CIM 250 (see section 6.1.2 Inserting the SIM card).
4	Connect the mains cable to the CIU 250 (see the CIU quick-guide instruction), and power on the CIU 250.
5	Power on the Grundfos product.
6	Observe that LED2 turns steady green (see section 6.2 Status LEDs), indicating that the GENIbus connection is working.
7	Observe that LED1 blinks yellow and changes to yellow pulsing after approximately 30 s (see section 6.2 Status LEDs), indicating that the GSM connection is working.
8	For configuring the CIM 250 for a GPRS connection, follow the instructions in the "CIM 250 SMS commands installation and operating instructions" (included on CIM/CIU support files CD), sections 2.1, 2.2 and 2.4.

The CIU 250 is now ready to be accessed from a Modbus TCP master via GPRS (or via SMS commands).

10.4 Modbus TCP communication setup (CIU 500)

Step	Action
1	Check that both CIU 500 unit and the MP 204 are powered off.
2	Remove the front cover of the CIU 500 unit.
3	Select position 1 at the CIM 500 module protocol rotary switch. See section 7.2 Setting the Industrial Ethernet protocol .
4	Connect the GENIbus cable from the CIU 500 to the MP 204. See fig. 5 in "CIU, Communication Interface Unit installation and operating instructions" or see the CIU quick guide.
5	Power on the CIU 500 unit and the MP 204, and observe LED2 turn steady green and LED1 remaining off.
6	Connect one of the CIU 500 Ethernet ports (RJ45) to a PC using an Ethernet cable.
7	Configure the PC Ethernet port to the same subnetwork as the CIM 500 (e.g. 192.168.1.1) and the subnet mask to 255.255.255.0. See section A.1 How to configure an IP address on your PC on page 43.
8	Open your internet browser and make contact to the CIM 500 Web server. Factory default address: 192.168.1.100
9	Log in to the Web server. Default: User: admin Password: Grundfos
10	In the menu column to the left select: Configuration > Real time Ethernet protocol
11	Type in an IP address belonging to the same subnet as your PC (e.g. 192.168.1.2).
12	Type in the subnet mask 255.255.255.0, and leave the rest of the settings at their factory default values.
13	Click [Submit] to transfer the new settings and close the Web browser.

CIM 500 is now ready to be accessed from a Modbus TCP master via one of its Ethernet ports. Use the IP address selected under step 10. The Modbus address (Unit ID) in the Modbus TCP telegram is not used.

- The CIU 500 LED 1 will be flashing green when Modbus TCP communication takes place.
- You can use the two Ethernet ports for daisy chaining of CIM 500 modules.
- It is possible to have connection to the Web server simultaneously with a connection to a Modbus TCP master.
- It is possible to have connection to more Modbus TCP masters simultaneously, e.g. to have connection to PC Tool CIM/CIU while connected to another Modbus TCP master.

11. Detailed descriptions of functionality

11.1 GSM

11.1.1 Call-up functional description

The call-up function is used for SCADA system communication via the GSM network. Connection is established when the SCADA system dials the CIU 250. The CIU 250 will automatically "pick up the phone" and wait for data traffic in the form of Modbus RTU telegrams.

If legal data traffic has not been initiated within one minute, the CIU 250 will hang up the line. This silence timeout is active during the whole communication session. Whenever the SCADA system has completed the Modbus communication, it hangs up the line. This is detected by the CIU 250, which also hangs up the line, and the call-up communication session is thereby completed. See fig. 19.

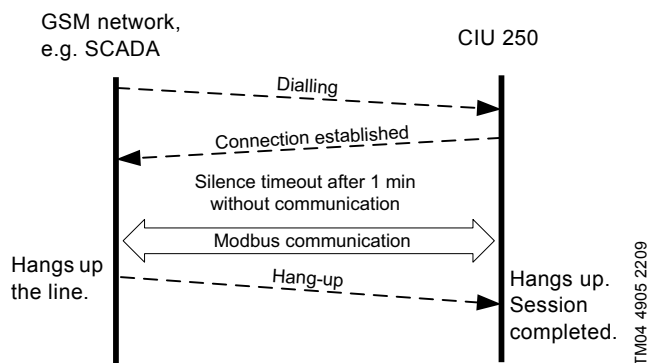

Fig. 19 Illustration of a GSM call-up session

11.1.2 SCADA PIN code protection

It is always possible to get read access via Modbus, but if the CIU 250 is SCADA PIN-code-protected (GeneralStatus register 00029, bit 0 = 1), write access requires that the correct PIN code (ScadaPinCode, register 00011) has been written. Writing the correct PIN code will trigger the write access control, and write access will be open, which can be verified with GeneralStatus, register 00029, bit 1 = 1).

For call-up connections with PIN code protection, the ScadaPinCode register has to be written each time a new call-up is made.

11.1.3 GSM call-up options setup

To prepare the CIU 250 for Modbus communication with a SCADA system via GSM, some settings have to be made via SMS commands:

- Setting a SCADA PIN code:
SETSCADACODE <access code> will enable write access protection.

Default is an empty SCADA PIN code, meaning no protection.

- Activating the SCADA PIN code:
SCADACODE <ON | OFF>.

Default is "Off".

- Selecting the Modbus address:
MODBUSADDR <1-247>

Default value is 231.

To verify the SCADA GSM setting after completion, the SMS command "SCADA" can be used.

For details about the use of SMS commands, see "CIM 250 SMS commands" (supplement to the installation and operating instructions) on the CD-ROM supplied with the GSM module.

11.2 GPRS

11.2.1 What is GPRS and Modbus TCP?

GPRS (General Packet Radio Service) is a wireless, "always on" connection that remains active as long as the CIU 250 is within range of the service. With GPRS it is possible to establish a wireless connection to the Internet and thus enable a remote connection to a SCADA system computer or another PC application. Typical data rates are 32 to 48 kbit/s.

The GPRS itself takes care of the wireless data transfer via the GSM network. It plays the same role as Ethernet in a wired network. On top of GPRS is the TCP/IP protocol, which enables easy integration with the Internet. The Modbus TCP protocol is used on the application layer communicating with a TCP port number (default 502). The difference when compared to the fieldbus protocol Modbus RTU is the exclusion of the 16-bit CRC checksum and the adding of a Modbus application program header as illustrated in fig. 20.

11.2.2 Subscription

The GSM service providers have different technical solutions for GPRS to choose from. You have to select the service provider and the technical solution that best suit your system, and it must be based on static IP addressing. You will get the following from the GSM service provider:

- A Subscriber Identity Module (SIM card).
- An Access Point Name (APN), e.g. "Internet".
- A user name (is fixed and cannot be changed by the user).
- A password (is fixed and cannot be changed by the user).
- A static IP address.

Solutions based on a VPN (Virtual Private Network) involve the use of special routers, e.g. GRE (Generic Routing Encapsulation) routers, which you will also get from the service provider.

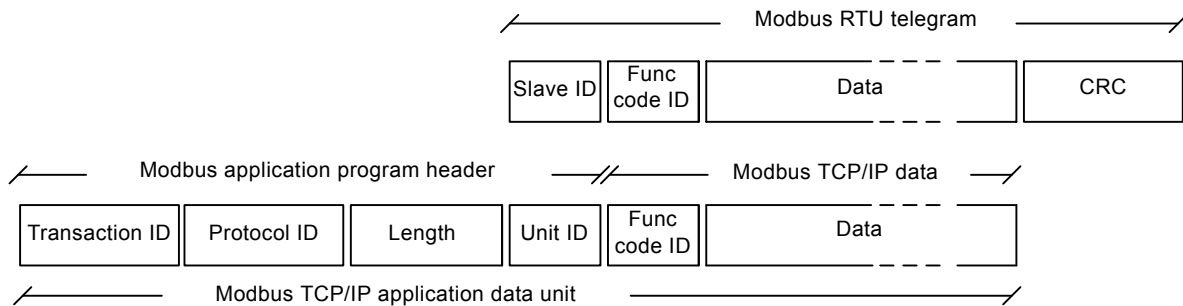

Fig. 20 Modbus TCP telegram

11.2.3 Installation

To prepare the CIU 250 for GPRS communication, some settings have to be made via SMS commands:

- Select Access Point Name:
APN <ascii string>
This is always mandatory.
- Select Username:
USERNAME <ascii string>
The need for a user name depends on your operator and the type of subscription.
- Select Password:
PASSWORD <ascii string>
The need for a password depends on your operator and the type of subscription.

Some advanced GPRS settings have default values that usually work, but in special cases, it might be necessary to change some of them. This is also done via SMS commands.

- Select Authentication:
AUTHENTICATION <NORMAL | SECURE>
Only used by some service providers. Default value is "Normal".
- Select Connection type:
CONNECTION <SERVER | CLIENT | DISABLE>
Default value is "Server".
- Set GPRS roaming:
GPRSROAMING: <ON | OFF>
Default value is "Off".
- Select Modbus TCP port number:
MODBUSPORT <port number>
Default value is 502.
- Select GENIpro port number:
GENIPROPORT <port number>
Default value is 49152. This is only relevant when using Grundfos PC Tools.

It is possible to configure the GPRS connection with a single multi-parameter command:

- SETGPRS <parameter 1, parameter 2, parameter 3, ...>
– <parameters>:<APN>,<Modbus port>,<GENIproport>,<username>,<password>,<authentication>,<connection>,<GPRS roaming>

Example

SETGPRS

Grundfos.dk2.tdc,502,49888,Grundfos,4321,normal,server,off

To verify the GPRS setting after completion, the SMS command GPRSSETTING can be used. The command GPRSSTATUS can verify if the GPRS connection is working.

The connection states have the following meaning:

- "Detached": Trying to locate GPRS service.
- "Attached": GPRS service located.
- "Context active": IP address has been assigned, ready for a client to establish a socket connection.
- "Connected": A client has established a socket connection. The system is ready for TCP/IP data exchange (or already exchanging data).

For details about the use of SMS commands, see "CIM 250 SMS commands" (supplement to the installation and operating instructions) on the CD-ROM supplied with the GSM module.

11.2.4 Operation

When powering on a CIU 250 with the correct GPRS setting, the following GPRS connection sequence will take place:

1. The CIU 250 locates the GPRS service. The connection state changes from "Detached" to "Attached".
2. The CIU 250 attempts to connect to the APN it has been given and requests an IP address. The base station looks through its record of legal SIM cards and finds the IP address (the address associated with this SIM card) to assign to the CIU 250. After the CIU 250 has got the IP address, the connection state changes to "Context active".
3. The CIU 250 is now ready for a client (e.g. SCADA system) to establish a socket connection and begin TCP/IP data exchange. When a client connects the CIU 250, the connection state will change to "Connected", and the GSM status LED1 will indicate when data transfer takes place. See section 5.5 Status LEDs.

Note When no GPRS data is being transferred, the connection states "Attached", "Context active" and "Connected".

All show the same LED1 status (short pulse).

A client, e.g. SCADA, establishes connection to a CIU 250 by specifying the IP address and the TCP port 502. Data transfer is always initiated from the client in the form of a Modbus TCP telegram embedded in a TCP/IP frame and directed to TCP port 502. To the client software, the connection to the CIU 250 is completely transparent.

The protection against unauthorised data access is high. The access to the GPRS network from the Internet can only take place via the VPN tunnel. See fig. 22. Moreover, data transfer requires a Modbus master client, knowledge of the Modbus functional profile and the use of a SCADA PIN code, if enabled. The CIU 250 supervises the GPRS system to ensure that it is still working. An automatic procedure ensures restarting of the CIU 250 and repetition of the GPRS connection sequence in case a deadlock situation has occurred. It also closes down socket connections that are left open by the client and unused for more than 24 hours.

It is possible to use SMS communication while GPRS communication is active. However, in the "Connected" state the delay time between reception and reply will increase. If the connection state is different from "Connected", it is possible to establish a call-up connection. When the call-up connection is established, GPRS data exchange will be blocked until the call-up is terminated by the caller.

A total of three Modbus clients can be connected to the Modbus TCP port of the CIU 250 and communicate simultaneously. Each connection, called a socket connection, is handled independently. If all three sockets are used simultaneously, a "Silence timeout" of only one minute is used to prevent a complete occupation for a long time.

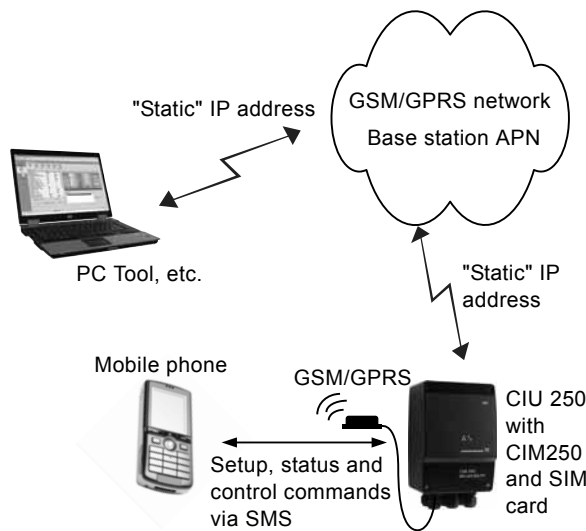

Fig. 21 GPRS connection from a PC to the CIU 250 directly via GPRS

TM04 7309 1510

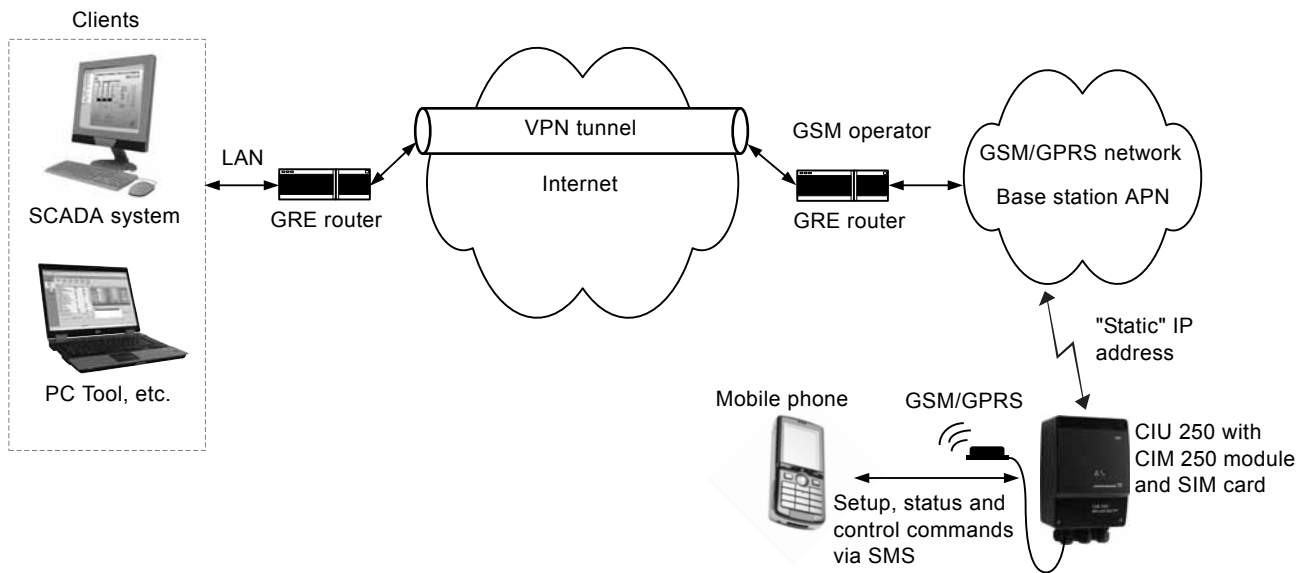

Fig. 22 GPRS connection via VPN tunnel

TM04 7129 1510

12. Modbus RTU telegram examples

Note *CRC fields are not shown in the following examples.*

Note *The Modbus data model states that registers numbered X are addressed in telegrams as X - 1, e.g. register 00104 (setpoint) is addressed as 00103 in a Modbus telegram.*

12.1 Modbus telegram overview

The maximum size of a Modbus RTU telegram is 256 bytes. Telegrams must be separated by a silent interval of at least 3.5 character times.

The standard Modbus RTU telegram format is shown in the table below.

Slave address	Function code	Data	CRC
1 byte	1 byte	0 to 252 bytes	2 bytes

A telegram starts with the slave address occupying one byte. Then comes a variable-size data field. For each telegram, a CRC is calculated and appended to the telegram (two bytes total). All bytes in the telegram, except for the CRC itself, are included in the check.

Note *The CRC bytes are not shown in the examples in the following sections.*

12.2 Read holding registers (0x03)

This function is used for reading holding registers from the slave. The request telegram specifies the starting address (the address of the first register to be read) and the number of holding registers to read. In the telegram, register addresses start from zero, meaning that registers numbered 1-16 are addressed as 0-15.

Example of request from master to slave

Field	Value
Address	0x01
Function code	0x03
Start address HI	0x00
Start address LO	0x6B
Quantity HI	0x00
Quantity LO	0x03

In the request, the slave with address 1 is asked to deliver three contiguous registers starting from address 0x006b = 107 (meaning register 108).

Example of response from slave to master

Field	Value
Address	0x01
Function code	0x03
Byte count	0x06
Register 108 HI	0x00
Register 108 LO	0x01
Register 109 HI	0x00
Register 109 LO	0x01
Register 110 HI	0x00
Register 110 LO	0x01

In the response, the byte count is six since there are three registers of two bytes. All three registers hold the value of 0x0001.

12.3 Read input registers (0x04)

This function is used for reading input registers from the slave. Input registers are read-only registers by definition. The request telegram specifies the starting address (the address of the first register to be read) and the number of holding registers to read. In the telegram, register addresses start from zero, meaning that registers numbered 1-16 are addressed as 0-15.

Example of request from master to slave

Field	Value
Address	0x01
Function code	0x04
Start address HI	0x10
Start address LO	0x10
Quantity HI	0x00
Quantity LO	0x03

In the request, the slave with address 1 is asked to deliver three contiguous registers starting from address 0x1010 = 4112 (meaning register 4113).

Example of response from slave to master

Field	Value
Address	0x01
Function code	0x04
Byte count	0x06
Register 4113 HI	0x22
Register 4113 LO	0x22
Register 4114 HI	0x22
Register 4114 LO	0x22
Register 4115 HI	0x22
Register 4115 LO	0x22

In the response, the byte count is six since there are three registers of two bytes. All three registers hold the value of 0x2222.

12.4 Write single register (0x06)

This function is used for writing a single holding register in the slave. The request telegram specifies the address of the register that is to be written. Register addresses start from zero, meaning that a register numbered 10 is addressed as 9.

The normal response is an echo of the request, indicating that the value was written.

Example of request from master to slave

Field	Value
Address	0x01
Function code	0x06
Address HI	0x10
Address LO	0x00
Value HI	0xAF
Value LO	0xFE

In the request, the slave with address 1 is asked to write the value of 0xAFFE to the register at address 0x1000.

Example of response from slave to master

Field	Value
Address	0x01
Function code	0x06
Address HI	0x10
Address LO	0x00
Value HI	0xAF
Value LO	0xFE

The response is an echo of the request.

12.5 Write multiple registers (0x10)

This function is used for writing a block of contiguous holding registers in the slave. Register addresses start from zero, meaning that a register numbered 100 is addressed as 99.

Example of request from master to slave

Field	Value
Address	0x01
Function code	0x10
Start address HI	0x00
Start address LO	0x00
Quantity HI	0x00
Quantity LO	0x02
Byte count	0x04
Register 33 HI	0x00
Register 33 LO	0x01
Register34 HI	0xB0
Register34 LO	0xB0

In the request, the slave with address 1 is asked to write the value of 0x0001 to the register at address 0x0020 and the value of 0xB0B0 to the register at address 0x0021.

Example of response from slave to master

Field	Value
Address	0x01
Function code	0x10
Start address HI	0x00
Start address LO	0x20
Quantity written HI	0x00
Quantity written LO	0x02

The response returns the function code, starting address and quantity of registers written.

12.6 Diagnostics (0x08)

This function provides a test for checking the communication system between the master and the Grundfos slave. It contains a single-byte subcode to identify the test to be performed.

The following subcodes are supported:

Subcode	Name
0x00	Return query data Data in this request are to be echoed in the response. The response must be identical to the request, so this function is often used to verify Modbus communication.
0x01	Restart communications All communication counters are cleared, and the device is restarted.
0x02	Return diagnostics register Returns the 16-bit diagnostics register. See section 12.7 Diagnostics register interpretation .
0x04	Force Listen Only Forces the device into listen-only mode. This effectively mutes the device, making it unable to communicate on the network. To bring the device back to normal mode, a "Restart communications" command (code 0x08, subcode 0x01) must be issued.
0x0A	Clear counters and diagnostics register Clears all counters and the diagnostics register. (These are also cleared on power-up/restart).
0x0B	Return bus message count Returns the number of messages detected by the slave.
0x0C	Return bus CRC error count Returns the number of CRC errors in the slave.
0x0D	Return bus exception count Returns the number of Modbus exception responses that the slave has transmitted.
0x0E	Return slave message count Returns the number of messages that the slave has processed.
0x0F	Return slave no response count Returns the number of messages for which the slave has sent no response.
0x12	Return bus character overrun count Returns the number of overruns in the slave.
0x14	Clear overrun counter Clears the overrun counter. (This is also cleared on power-up/restart).

Example of response from master to slave

Field	Value
Address	0x01
Function code	0x08
Subcode	0x00
Data	0xAB
Data	0xCD

The response is identical to the request.

Example of response from slave to master

Field	Value
Address	0x01
Function code	0x08
Subcode	0x00
Data	0xAB
Data	0xCD

12.7 Diagnostics register interpretation

The diagnostics register is interpreted as follows:

Bit	Description
0	Internal communication failure (with the Grundfos CIU 250).
1	EEPROM self-test failed (the test is carried out when the system is booted).
2	Grundfos CIU 250 not supported.
3	Modbus address offset is different from default value, i.e. it differs from 0.
4	Using software-defined Modbus transmission speed.
5	RESERVED
6	RESERVED
7	RESERVED
8	RESERVED
9	RESERVED
10	RESERVED
11	RESERVED
12	RESERVED
13	RESERVED
14	RESERVED
15	RESERVED

A bit value of 1 means true, unless otherwise specified.
The diagnostics register is read using function code 0x08 and subcode 0x02.

12.8 Diagnostics: return query data

This function is useful to ensure that the communication path and slave configuration are correct. It will echo the request in the response.

In the example, slave address 0x01 is used.

Request from master to slave

Field	Value	Description
Slave address	0x01	-
Function code	0x08	Diagnostics
Subcode	0x00	Echo request
Data	0xAB	Test data
Data	0xCD	Test data

Example of response from slave to master

Field	Value	Description
Slave address	0x01	-
Function code	0x08	Diagnostics
Subcode	0x00	Echo request
Data	0xAB	Test data
Data	0xCD	Test data

If there is no response from the slave, see section [13. Fault finding](#).

12.9 Reading the CIM configuration register block

This section shows how to read the first four registers of the CIM configuration register block.

In the example, slave address 0x01 is used.

Request from master to slave

Field	Value	Description
Slave address	0x01	-
Function code	0x04	Read input registers
Start address HI	0x00	Start address
Start address LO	0x00	= 0x0001
Quantity HI	0x00	Number of registers
Quantity LO	0x04	= 0x0004

Example of response from slave to master

Field	Value	Description
Slave address	0x01	-
Function code	0x04	Read input registers
Byte count	0x08	8 bytes follow
00001 HI	0x00	SlaveMinimumReplyDelay
00001 LO	0x0A	= 0x000A
00002 HI	0x00	RegisterOffset
00002 LO	0x00	= 0x0000
00003 HI	0x00	Reserved value
00003 LO	0x00	= 0x0000
00004 HI	0x00	ModbusBitRate
00004 LO	0x04	= 0x0004

If there is no response from the slave, see section [12.2 Read holding registers \(0x03\)](#).

12.10 Tripping the MP 204

This section shows how to set the control bit that trips the MP 204.

In the example, slave address 0x01 is used.

To trip the MP 204, the ControlRegister (register address 00101, bit 1) must be raised.

Hence the value to set is 0b0000000000000010 = 0x0002.

Request from master to slave

Field	Value	Description
Slave address	0x01	-
Function code	0x06	Write single register
Start address HI	0x00	ControlRegister address
Start address LO	0x64	= 00101 (0x0065)
Value HI	0x00	ControlRegister value
Value LO	0x02	= 2 (0x0002)

Example of response from slave to master

Field	Value	Description
Slave address	0x01	-
Function code	0x06	Write single register
Start address HI	0x00	ControlRegister address
Start address LO	0x64	= 00101 (0x0065)
Value HI	0x00	ControlRegister value
Value LO	0x02	= 2 (0x0002)

If there is no response from the slave, see section [13. Fault finding](#).

12.11 Resetting an alarm

This section shows how to set the control bit that resets MP 204 alarms.

In the example, slave address 0x01 is used.

To reset an alarm, the ControlRegister (register address 00101, bit 0) must be raised.

Hence the value to set is 0b0000000000000001 = 0x0001.

Request from master to slave

Field	Value	Description
Slave address	0x01	-
Function code	0x06	Write single register
Start address HI	0x00	ControlRegister address
Start address LO	0x64	= 00101 (0x0065)
Value HI	0x00	ControlRegister value
Value LO	0x01	= 1 (0x0001)

Example of response from slave to master

Field	Value	Description
Slave address	0x01	-
Function code	0x06	Write single register
Start address HI	0x00	ControlRegister address
Start address LO	0x64	= 00101 (0x0065)
Value HI	0x00	ControlRegister value
Value LO	0x01	= 1 (0x0001)

If there is no response from the slave, see section [13. Fault finding](#).

13. Fault finding

13.1 CIU 200

Faults in a CIU 200 can be detected by observing the status of the two communication LEDs. See the table below and section [5.5 Status LEDs](#).

13.1.1 LED status

Fault (LED status)	Possible cause	Remedy
1. Both LEDs (LED1 and LED2) remain off when the power supply is connected.	a) The CIU 200 is defective.	Replace the CIU 200.
2. The LED for internal communication (LED2) is flashing red.	a) No internal communication between the CIU 200 and the MP 204	<ul style="list-style-type: none"> • Check the cable connection between the MP 204 and the CIU 200. • Check that the individual conductors have been fitted correctly. • Check the power supply to the MP 204.
3. The LED for internal communication (LED2) is constantly red.	a) The CIU 200 does not support the MP 204 which is connected.	Contact the nearest Grundfos company.
4. The Modbus LED (LED1) is constantly red.	a) Fault in the CIM 200 Modbus configuration.	<ul style="list-style-type: none"> • Check the transmission speed (switches SW4 and SW5). If the switches are set to "software-defined", an invalid value may have been set via Modbus. Try one of the preselected transmission speeds, e.g. 19200 bits/s. • Check that the Modbus address (switches SW6 and SW7) has a valid value [1-247].
5. The Modbus LED (LED1) is flashing red.	a) Fault in the Modbus communication (fault in parity or cyclic redundancy check).	<ul style="list-style-type: none"> • Check the transmission speed (switches SW4 and SW5). See section 5.1 Setting the Modbus transmission speed. • Check the parity setting (switch SW3). See section 5.2 Setting the parity. • Check the cable connection between the CIM 200 and the Modbus network. • Check the termination resistor settings (switches SW1 and SW2). See section 5.4 Termination resistor.

13.1.2 CIU 200 Modbus communication faults

Fault	Possible cause	Remedy
1. The slave does not respond to telegrams.	a) Configuration or wiring error.	<ul style="list-style-type: none"> • Check the visual diagnostics on the Modbus slave. Is the Grundfos GENIbus LED flashing green and the Modbus LED off or flashing green? • Ensure that the cable between the Modbus master and the Modbus slave is connected correctly. See section 5. Modbus RTU, CIM 200 setup for wiring recommendations. • Ensure that the slave address is configured correctly, and that the correct slave address is used in the Modbus master poll. See section 5.3 Modbus address selection for slave address selection. • Ensure that the transmission speed and stop bit/parity settings are configured correctly in both master and slave. • Ensure that each end of the Modbus trunk cable is terminated, if necessary. See section 5.4 Termination resistor for line termination of the Grundfos slave. • Ensure that the bus topology for a Modbus network is correct.
	b) The slave may be in listen-only mode.	Either send a restart communications diagnostics command, or restart the MP 204 manually.
	c) If the holding register of address 00001 "SlaveMinimumReplyDelay" is set too high, the master may time out before receiving the response from the slave.	Increase the timeout span in the master in order to communicate.
2. The slave responds with exception response 0x01: "Invalid function".	a) The master is trying to use an unsupported function in the CIU.	See section 8. Modbus function code overview for supported function codes. Note that reading and writing coils are not supported, so only register functions and diagnostics will be valid.
3. The slave responds with exception response 0x02: "Invalid data address".	a) The master is trying to read or write an invalid data address. If a master tries to read register addresses that are not listed in the tables, the slave will respond with this exception response. Some masters may automatically try to read large blocks in one telegram, which will cause problems if some of the registers in the block are not supported. An example would be reading the CIM configuration and CIM status blocks in one telegram. This is not possible since there are unused addresses between the blocks.	<ul style="list-style-type: none"> • Avoid reading or writing invalid data addresses. • Ensure that register X is addressed as X - 1 in Modbus telegrams, according to the Modbus standard.
	b) The register address offset may have been changed from default.	Read the holding register at address 00002 "Register Offset" to see if this value is different from 0. If so, write the value 0 to this address to make the slave return to the default used in this functional profile.
4. The slave returns data value 0xFFFF (65535).	a) The value is unavailable. A data value of 0xFFFF does not necessarily indicate an error condition. It means that the value is unavailable from the MP 204.	See section 9. Modbus register overview for available data.
	b) The MP 204 is not configured to show the value or lacks a sensor to read the value.	See section 9.9 MP 204 data register block for data values that require a sensor.
5. The slave does not change Modbus transmission speed with register 0004.	a) Configuration error.	Set the transmission speed switches to "Software-defined". (Otherwise, the value in register 0004 is ignored by the slave).
	b) An invalid value may be set in register 00004.	See section 5.1 Setting the Modbus transmission speed for invalid values, and set correct value in register 00004.

13.2 CIU 250

Faults in the CIU 250 can be detected by observing the status of the two communication LEDs. See the table below and section [3.3 CIU 250 Modbus GSM/GPRS](#).

13.2.1 LED status

Fault (LED status)	Possible cause	Remedy
1. Both LEDs (LED1 and LED2) remain off when the power supply is connected.	a) The CIM 250 is fitted incorrectly in the Grundfos MP 204.	Ensure that the CIM 250 is fitted/connected correctly.
	b) The CIM 250 is defective.	Replace the CIM 250.
2. The LED for internal communication (LED2) is flashing red.	a) No internal communication between the CIM 250 and the Grundfos MP 204.	Ensure that the CIM250 is fitted correctly in the Grundfos MP 204.
3. The LED for internal communication (LED2) is constantly red.	a) The CIM 250 does not support the Grundfos MP 204 connected.	Contact the nearest Grundfos company.
4. The LED for GSM/GPRS communication (LED1) is flashing yellow. See signal 1 in fig. 13 on page 11.	a) The SIM card has not been inserted.	Insert the SIM card. See section 6.1.2 Inserting the SIM card .
	b) The SIM card has not been inserted correctly.	Insert the SIM card. See section 6.1.2 Inserting the SIM card .
	c) The SIM card PIN code is not correct.	Enter the correct PIN code. See section 6.1.2 Inserting the SIM card .
	d) No connection to the GSM network.	<ul style="list-style-type: none"> • Check the connection to the antenna. • Check the GSM coverage of the area using e.g. a mobile phone. • Use an external antenna and experiment with the position.
5. The LED for GSM/GPRS communication is pulsating yellow with single pulse, but the CIM 250 cannot send or receive SMS messages.	a) The CIM 250 has not been initialised.	Follow the configuration procedure in "CIM 250 SMS commands" (supplement to installation and operating instructions) on the CD-ROM supplied with the GSM module.

13.2.2 CIU 250 Modbus GSM/GPRS communication faults

Fault	Possible cause	Remedy
1. The slave does not respond to telegrams.	a) Configuration or installation error.	<ul style="list-style-type: none"> Ensure that the CIU 250 has contact with the GSM network. The LED1 should be pulsing yellow. If the LED1 signal is incorrect, see section 6. <i>Modbus GSM/GPRS, CIM 250 setup</i> for correct installation of the CIM 250. Ensure that the correct slave address is used in the Modbus master poll. See register 00003 SoftwareDefinedModbusAddress (factory value is 00231).
	b) The slave may be in listen-only mode.	Either send a restart communications diagnostics command, or restart the MP 204 manually.
	c) If the holding register of address 00001 "SlaveMinimumReplyDelay" is set too high, the master may time out before receiving the response from the slave.	Increase the reply delay in the master, or reduce the "SlaveMinimumReplyDelay" in order to communicate.
2. The slave responds with exception response 0x01: "Invalid function".	a) The master is trying to use an unsupported function in the CIM/CIU 250.	See section 12. <i>Modbus RTU telegram examples</i> for supported function codes. Note that reading and writing coils are not supported, so only register functions and diagnostics will be valid.
3. The slave responds with exception response 0x02: "Invalid data address".	a) The master is trying to read or write an invalid data address. If a master tries to read register addresses that are not listed in the tables, the slave will respond with this exception response. Some masters may automatically try to read large blocks in one telegram, which will cause problems if some of the registers in the block are not supported. An example would be reading the CIM configuration and CIM status register blocks in one telegram. This is not possible since there are unused addresses among the blocks.	Avoid reading or writing invalid data addresses. Ensure that register X is addressed as X - 1 in Modbus telegrams, according to the Modbus standard.
4. The slave returns data value 0xFFFF (65535).	a) The availability of data will in some cases depend on a configuration or the actual conditions of the system (e.g. trying to request data from a MP 204 which is not present will return "data not available" (0xFFFF)).	See section 9. <i>Modbus register overview</i> for available data.
	b) With its present configuration or operating mode, the MP 204 is unable to supply the requested data.	See section 9.9 <i>MP 204 data register block</i> for data values that require a sensor.
5. The slave does not react to control actions or to writing of settings.	a) The CIU 250 is SCADA PIN-code-protected (GeneralStatus register 00029, bit 0 = 1), and an incorrect PIN code has been written.	Write access requires a correct PIN code (ScadaPinCode, register 00011). Writing the correct PIN code value will trigger the write access control, and write access will be open, which can be verified with GeneralStatus, register 00029, bit 1 = 1.

13.3 CIU 500

Faults in the CIU 500 can be detected by observing the status of the two communication LEDs. See the table below and section [4.4 CIU 500 Modbus TCP](#).

13.3.1 LED status

Fault (LED status)	Possible cause	Remedy
1. Both LEDs (LED1 and LED2) remain off when the power supply is connected.	a) The CIU 500 is defective.	Replace the CIU 500.
2. The LED for internal communication (LED2) is flashing red.	a) No internal communication between the CIU 500 and the Grundfos product.	<ul style="list-style-type: none"> • Check the cable connection between the Grundfos product and the CIU 500. • Check that the individual conductors have been fitted correctly, e.g. not reversed. • Check the power supply to the Grundfos product.
3. The LED for internal communication (LED2) is permanently red.	a) The CIM 500 does not support the Grundfos product connected.	Contact the nearest Grundfos company.
4. The Ethernet LED (LED1) is permanently red.	a) Fault in the CIM 500 Modbus TCP configuration.	Check that the rotary switch SW1 is set to 1 Check that Modbus TCP IP address configuration is correct. See section A.4 Modbus TCP configuration on page 44.
5. LED1 is permanently red and green at the same time.	a) Error in firmware download.	Use the Web server to download the firmware again.
6. LED2 is permanently red and green at the same time.	a) Memory fault.	Replace the CIM 500.

13.3.2 CIU 500 Modbus TCP communication faults

Fault	Possible cause	Remedy
1. The slave does not respond to telegrams	a) Configuration or wiring error	<ul style="list-style-type: none"> • Check the visual diagnostics on the Modbus slave. Normal conditions are that the Grundfos GENIbus LED (LED2) is constantly green and that the Modbus TCP LED (LED1) is off or flashing green. If this is not fulfilled see section 13.3.1 LED status. • Ensure that the cable between the Modbus TCP master and the Modbus slave is connected correctly. See section 7.1 Connecting the Ethernet cable. • Ensure that the slave IP address is configured correctly, and that the correct slave IP address is used in the Modbus master poll. See section 7.3 Setting up the IP addresses.
2. The slave responds with exception response 0x01 "Invalid function"	a) The master is trying to use an unsupported function in the CIU 500.	See section 8. Modbus function code overview for supported function codes. Note that reading and writing coils are not supported, so only register functions and diagnostics will be valid.
3. The slave responds with exception response 0x02 "Invalid data address"	a) The master is trying to read or write an invalid data address. If a master tries to read register addresses that are not listed in the tables, the slave will respond with this exception response. Some masters may automatically try to read large blocks in one telegram, which will cause problems if some of the registers in the block are not supported. An example would be reading the CIM configuration and CIM status blocks in one telegram: this is not possible since there are unused addresses between the blocks.	Avoid reading or writing invalid data addresses. Ensure that a block of registers starting at address X is addressed as X - 1 in Modbus telegrams, according to the Modbus standard.
	b) The register address offset may have been changed from default.	Read the holding register at address 00002 "Register Offset" to see if this value is different from 0. If so, write the value 0 to this address to make the slave return to the default used in this functional profile.
4. The slave returns data value 0xFFFF (65535)	a) The value is unavailable. A data value of 0xFFFF does not necessarily indicate an error condition. It means that the value is unavailable from the MP 204.	See section 9. Modbus register overview for available data.
	b) The MP 204 is not configured to show the value or lacks a sensor to read the value.	See section 9.9 MP 204 data register block for data values that require a sensor.
5. The slave does not react to control actions or to writing of settings.	The MP 204 might be in "Local" mode, in which case Operating mode, Control mode and Setpoint cannot be changed from bus. Register 00201 bit 8 AccessMode must be "1" (= Remote) for bus control to be active.	Set the MP 204 in "Remote mode" by setting register 00101 bit 0 RemoteAccessReq to "1" (= Remote). The MP 204 should show "Controlled from bus" when status is read by handheld controllers R100 or GO Remote.

14. Modbus RTU rotary switch addresses

Modbus address	SW 6	SW 7	Modbus address	SW 6	SW 7	Modbus address	SW 6	SW 7	Modbus address	SW 6	SW 7	Modbus address	SW 6	SW 7
1	0	1	51	3	3	101	6	5	151	9	7	201	C	9
2	0	2	52	3	4	102	6	6	152	9	8	202	C	A
3	0	3	53	3	5	103	6	7	153	9	9	203	C	B
4	0	4	54	3	6	104	6	8	154	9	A	204	C	C
5	0	5	55	3	7	105	6	9	155	9	B	205	C	D
6	0	6	56	3	8	106	6	A	156	9	C	206	C	E
7	0	7	57	3	9	107	6	B	157	9	D	207	C	F
8	0	8	58	3	A	108	6	C	158	9	E	208	D	0
9	0	9	59	3	B	109	6	D	159	9	F	209	D	1
10	0	A	60	3	C	110	6	E	160	A	0	210	D	2
11	0	B	61	3	D	111	6	F	161	A	1	211	D	3
12	0	C	62	3	E	112	7	0	162	A	2	212	D	4
13	0	D	63	3	F	113	7	1	163	A	3	213	D	5
14	0	E	64	4	0	114	7	2	164	A	4	214	D	6
15	0	F	65	4	1	115	7	3	165	A	5	215	D	7
16	1	0	66	4	2	116	7	4	166	A	6	216	D	8
17	1	1	67	4	3	117	7	5	167	A	7	217	D	9
18	1	2	68	4	4	118	7	6	168	A	8	218	D	A
19	1	3	69	4	5	119	7	7	169	A	9	219	D	B
20	1	4	70	4	6	120	7	8	170	A	A	220	D	C
21	1	5	71	4	7	121	7	9	171	A	B	221	D	D
22	1	6	72	4	8	122	7	A	172	A	C	222	D	E
23	1	7	73	4	9	123	7	B	173	A	D	223	D	F
24	1	8	74	4	A	124	7	C	174	A	E	224	E	0
25	1	9	75	4	B	125	7	D	175	B	F	225	E	1
26	1	A	76	4	C	126	7	E	176	B	0	226	E	2
27	1	B	77	4	D	127	7	F	177	B	1	227	E	3
28	1	C	78	4	E	128	8	0	178	B	2	228	E	4
29	1	D	79	4	F	129	8	1	179	B	3	229	E	5
30	1	E	80	5	0	130	8	2	180	B	4	230	E	6
31	1	F	81	5	1	131	8	3	181	B	5	231	E	7
32	2	0	82	5	2	132	8	4	182	B	6	232	E	8
33	2	1	83	5	3	133	8	5	183	B	7	233	E	9
34	2	2	84	5	4	134	8	6	184	B	8	234	E	A
35	2	3	85	5	5	135	8	7	185	B	9	235	E	B
36	2	4	86	5	6	136	8	8	186	B	A	236	E	C
37	2	5	87	5	7	137	8	9	187	B	B	237	E	D
38	2	6	88	5	8	138	8	A	188	B	C	238	E	E
39	2	7	89	5	9	139	8	B	189	B	D	239	E	F
40	2	8	90	5	A	140	8	C	190	B	E	240	F	0
41	2	9	91	5	B	141	8	D	191	B	F	241	F	1
42	2	A	92	5	C	142	8	E	192	C	0	242	F	2
43	2	B	93	5	D	143	8	F	193	C	1	243	F	3
44	2	C	94	5	E	144	9	0	194	C	2	244	F	4
45	2	D	95	5	F	145	9	1	195	C	3	245	F	5
46	2	E	96	6	0	146	9	2	196	C	4	246	F	6
47	2	F	97	6	1	147	9	3	197	C	5	247	F	7
48	3	0	98	6	2	148	9	4	198	C	6			
49	3	1	99	6	3	149	9	5	199	C	7			
50	3	2	100	6	4	150	9	6	200	C	8			

Example: To set the slave address to the value 142, set the rotary switches SW6 and SW7 to "8" and "E", respectively. Please note that 0 is not a valid slave address as this is used for broadcasting.

Caution

It is very important to ensure that two devices do not have the same address on the network. If two devices have the same address, the result will be an abnormal behaviour of the whole serial bus.

15. Grundfos alarm and warning codes

This is a complete list of alarm and warning codes for Grundfos products. Not all codes apply to all Grundfos products.

Code	Description	Code	Description	Code	Description
1	Leakage current	80	Hardware fault, type 2	186	Signal fault, power meter sensor
2	Missing phase	81	Verification error, data area (RAM)	187	Signal fault, energy meter
3	External fault signal	82	Verification error, code area (ROM, FLASH)	188	Signal fault, user-defined sensor
4	Too many restarts	83	Verification error, FE parameter area (EEPROM)	189	Signal fault, level sensor
5	Regenerative braking	84	Memory access error	190	Limit exceeded, sensor 1 (e.g. alarm level in WW application)
6	Mains fault	85	Verification error, BE parameter area (EEPROM)	191	Limit exceeded, sensor 2 (e.g. high level in WW application)
7	Too many hardware shutdowns	88	Sensor fault	192	Limit exceeded, sensor 3 (e.g. overflow level in WW application)
8	PWM switching frequency reduced	89	Signal fault, (feedback) sensor 1	193	Limit exceeded, sensor 4 (e.g. low level in WW/tank filling application)
9	Phase sequence reversal	90	Signal fault, speed sensor	194	Limit exceeded, sensor 5
10	Communication fault, pump	91	Signal fault, temperature sensor 1	195	Limit exceeded, sensor 6
11	Water-in-oil fault (motor oil)	92	Calibration fault, (feedback) sensor	196	Operation with reduced efficiency
12	Time for service (general service information)	93	Signal fault, sensor 2	197	Operation with reduced pressure
13	Moisture alarm, analog	94	Limit exceeded, sensor 1	198	Operation with increased power consumption
14	Electronic DC-link protection activated (ERP)	95	Limit exceeded, sensor 2	199	Process out of range (monitoring/estimation/calculation/control)
15	Communication fault, main system (SCADA)	96	Setpoint signal outside range	200	Application alarm
16	Other	97	Signal fault, setpoint input	201	External sensor input high
17	Performance requirement cannot be met	98	Signal fault, input for setpoint influence	202	External sensor input low
18	Commanded alarm standby (trip)	99	Signal fault, input for analog setpoint	203	Alarm on all pumps
19	Diaphragm break (dosing pump)	104	Software shutdown	204	Inconsistency between sensors
20	Insulation resistance low	105	Electronic rectifier protection activated (ERP)	205	Level float switch sequence inconsistency
21	Too many starts per hour	106	Electronic inverter protection activated (EIP)	206	Water shortage, level 1
22	Moisture switch alarm, digital	110	Skew load, electrical asymmetry	207	Water leakage
23	Smart trim gap alarm	111	Current asymmetry	208	Cavitation
24	Vibration	112	Cos ϕ too high	209	Non-return valve fault
25	Setup conflict	113	Cos ϕ too low	210	High pressure
26	Load continues even if the motor has been switched off	114	Motor heater function activated (frost protection)	211	Low pressure
27	External motor protector activated (e.g. MP 204)	120	Auxiliary winding fault (single-phase motors)	212	Diaphragm tank precharge pressure out of range
28	Battery low	121	Auxiliary winding current too high (single-phase motors)	213	VFD not ready
29	Turbine operation (impellers forced backwards)	122	Auxiliary winding current too low (single-phase motors)	214	Water shortage, level 2
30	Change bearings (specific service information)	123	Start capacitor, low (single-phase motors)	215	Soft pressure build-up time-out
31	Change varistor(s) (specific service information)	124	Run capacitor, low (single-phase motors)	216	Pilot pump alarm
32	Overvoltage	144	Motor temperature 3 (Pt100, t _{mo3})	217	Alarm, general-purpose sensor high
33	Soon time for service (general service information)	145	Bearing temperature high (Pt100), in general or top bearing	218	Alarm, general-purpose sensor low
34	No priming water	146	Bearing temperature high (Pt100), middle bearing	219	Pressure relief not adequate
35	Gas in pump head, deaerating problem	147	Bearing temperature high (Pt100), bottom bearing	220	Fault, motor contactor feedback
36	Discharge valve leakage	148	Motor bearing temperature high (Pt100) in drive end (DE)	221	Fault, mixer contactor feedback
37	Suction valve leakage	149	Motor bearing temperature high (Pt100) in non-drive end (NDE)	222	Time for service, mixer

Code	Description	Code	Description	Code	Description
38	Vent valve defective	152	Communication fault, add-on module	223	Maximum number of mixer starts per hour exceeded
40	Undervoltage	153	Fault, analog output	224	Pump fault (due to auxiliary component or general fault)
41	Undervoltage transient	154	Communication fault, display	225	Communication fault, pump module
42	Cut-in fault (dV/dt)	155	Inrush fault	226	Communication fault, I/O module
45	Voltage asymmetry	156	Communication fault, internal frequency converter module	227	Combi event
48	Overload	157	Real-time clock out of order	228	Night flow max. limit exceeded
49	Overcurrent (i_line, i_dc, i_mo)	158	Hardware circuit measurement fault	229	Water on floor
50	Motor protection function, general shutdown (MPF)	159	CIM fault (Communication Interface Module)	230	Network alarm
51	Blocked motor/pump	160	GSM modem, SIM card fault	231	Ethernet: No IP address from DHCP server
52	Motor slip high	161	Sensor supply fault, 5 V	232	Ethernet: Auto-disabled due to misuse
53	Stalled motor	162	Sensor supply fault, 24 V	233	Ethernet: IP address conflict
54	Motor protection function, 3 sec. limit	163	Measurement fault, motor protection	234	Backup pump alarm
55	Motor current protection activated (MCP)	164	Signal fault, LiqTec sensor	235	Gas detected
56	Underload	165	Signal fault, analog input 1	236	Pump 1 fault
57	Dry running	166	Signal fault, analog input 2	237	Pump 2 fault
58	Low flow	167	Signal fault, analog input 3	238	Pump 3 fault
59	No flow	168	Signal fault, pressure sensor	239	Pump 4 fault
60	Low input power	169	Signal fault, flow sensor	240	Lubricate bearings (specific service information)
64	Overtemperature	170	Signal fault, water-in-oil (WIO) sensor	241	Motor phase failure
65	Motor temperature 1 (t_m or t_mo or t_mo1)	171	Signal fault, moisture sensor	242	Automatic motor model recognition failed
66	Temperature, control electronics (t_e)	172	Signal fault, atmospheric pressure sensor	243	Motor relay has been forced (manually operated/commanded)
67	Temperature too high, internal frequency converter module (t_m)	173	Signal fault, rotor position sensor (Hall sensor)	244	Fault, On/Off/Auto switch
68	External temperature/water temperature (t_w)	174	Signal fault, rotor origo sensor	245	Pump continuous runtime too long
69	Thermal relay 1 in motor (e.g. Klixon)	175	Signal fault, temperature sensor 2 (t_mo2)	246	User-defined relay has been forced (manually operated/commanded)
70	Thermal relay 2 in motor (e.g. thermistor)	176	Signal fault, temperature sensor 3 (t_mo3)	247	Power-on notice (device/system has been switched off)
71	Motor temperature 2 (Pt100, t_mo2)	177	Signal fault, Smart trim gap sensor	248	Fault, battery/UPS
72	Hardware fault, type 1	178	Signal fault, vibration sensor	249	User-defined event 1
73	Hardware shutdown (HSD)	179	Signal fault, bearing temperature sensor (Pt100), general or top bearing	250	User-defined event 2
74	Internal supply voltage too high	180	Signal fault, bearing temperature sensor (Pt100), middle bearing	251	User-defined event 3
75	Internal supply voltage too low	181	Signal fault, PTC sensor (short-circuited)	252	User-defined event 4
76	Internal communication fault	182	Signal fault, bearing temperature sensor (Pt100), bottom bearing	253	SMS data from DDD sensor not received within time
77	Communication fault, twin-head pump	183	Signal fault, extra temperature sensor	254	Inconsistent data model
78	Fault, speed plug	184	Signal fault, general-purpose sensor		
79	Functional fault, add-on module	185	Unknown sensor type		

Subject to alterations.

Appendix

The appendix describes the parts of the CIM 500 web server needed for the configuration of a Modbus TCP Ethernet connection. For other CIM 500 web server features, not specifically related to Modbus TCP, see the installation and operating instructions for the CIM 500.

A.1 How to configure an IP address on your PC

For connecting a PC to the CIM 500 via Ethernet, the PC must be set up to use a fixed (static) IP address belonging to the same subnetwork as the CIM 500.

1. Open "Control Panel".
2. Enter "Network and Sharing Center".
3. Click "Change adapter settings".
4. Right-click and select "Properties" for Ethernet adapter. Typically "Local Area Connection".
5. Select properties for "Internet Protocol Version 4(TCP/IPv4)".
6. Select the "Alternate Configuration" tab.
7. Configure an IP address and subnet mask to be used by your PC. See fig. 1.

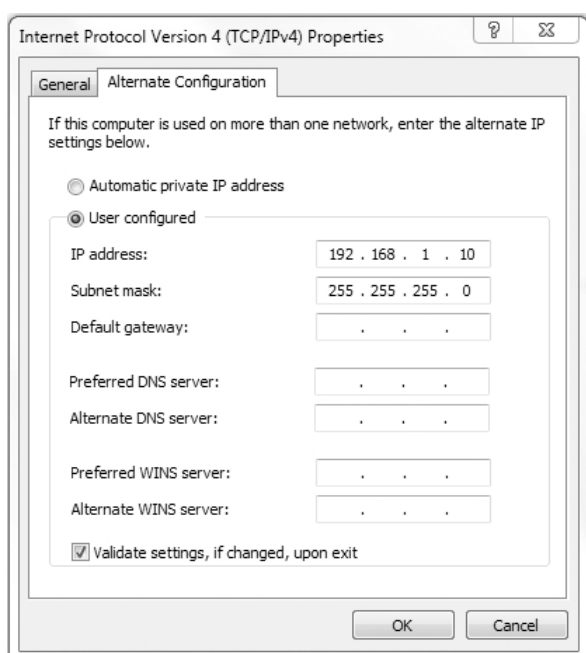

TM05 7422 1814

Fig. 1 Example from Windows 7

A.2 Web server configuration

The built-in web server is an easy and effective way to monitor the status of the CIM 500 module and configure the available functions and Industrial Ethernet protocols. The web server also makes it possible to update the firmware of the CIM module, and store/restore settings.

To establish a connection from a PC to CIM 500, proceed as follows:

Before configuration

- Check that the PC and CIM module are connected via an Ethernet cable.
- Check that the PC Ethernet port is set to the same network as the CIM module. For network configuration, see section [A.1 How to configure an IP address on your PC](#).

To establish a connection from a PC to the CIM 500 for the first time, the following steps are required:

1. Open a standard Internet browser and type 192.168.1.100 in the URL address field.
2. Log in to the web server.

A.3 Login

Fig. 2 Login

User name	Enter user name. Default: admin.
Password	Enter password. Default: Grundfos.

Note

User name and password can be changed on the web server under "UserManagement"

A.4 Modbus TCP configuration

Fig. 3 Real Time Ethernet Protocol Configuration - Modbus TCP

Object	Description
TCP Port Number	The default value is 502, the official IANA-assigned Modbus TCP port number. Number 502 will always be active implicitly. If you select another value in the web server configuration field, both the new value and value 502 will be active.
IP Address	The static IP address for CIM 500 on the Modbus TCP network.
Subnet Mask	The subnet mask for the CIM 500 module on the Modbus TCP network.
Gateway	The default gateway for the Modbus TCP network.
Use DHCP	The CIM 500 module can be configured to automatically obtain the IP address from a DHCP server on the network.

Argentina

Bombas GRUNDFOS de Argentina S.A.
Ruta Panamericana km. 37.500 Centro
Industrial Garin
1619 Garin Pcia. de B.A.
Phone: +54-3327 414 444
Telefax: +54-3327 45 3190

Australia

GRUNDFOS Pumps Pty. Ltd.
P.O. Box 2040
Regency Park
South Australia 5942
Phone: +61-8-8461-4611
Telefax: +61-8-8340 0155

Austria

GRUNDFOS Pumpen Vertrieb Ges.m.b.H.
Grundfosstraße 2
A-5082 Grödig/Salzburg
Tel.: +43-6246-883-0
Telefax: +43-6246-883-30

Belgium

N.V. GRUNDFOS Bellux S.A.
Boomssesteenweg 81-83
B-2630 Aartselaar
Tél.: +32-3-870 7300
Télécopie: +32-3-870 7301

Belarus

Представительство ГРУНДФОС в
Минске
220125, Минск
ул. Шафарьянская, 11, оф. 56, БЦ
«Порт»
Тел.: +7 (375 17) 286 39 72/73
Факс: +7 (375 17) 286 39 71
E-mail: minsk@grundfos.com

Bosna and Herzegovina

GRUNDFOS Sarajevo
Zmaja od Bosne 7-7A,
BH-71000 Sarajevo
Phone: +387 33 592 480
Telefax: +387 33 590 465
www.ba.grundfos.com
e-mail: grundfos@bih.net.ba

Brazil

BOMBAS GRUNDFOS DO BRASIL
Av. Humberto de Alencar Castelo Branco,
630
CEP 09850 - 300
São Bernardo do Campo - SP
Phone: +55-11 4393 5533
Telefax: +55-11 4343 5015

Bulgaria

Grundfos Bulgaria EOOD
Slatina District
Iztochna Tangenta street no. 100
BG - 1592 Sofia
Tel. +359 2 49 22 200
Fax. +359 2 49 22 201
email: bulgaria@grundfos.bg

Canada

GRUNDFOS Canada Inc.
2941 Brighton Road
Oakville, Ontario
L6H 6C9
Phone: +1-905 829 9533
Telefax: +1-905 829 9512

China

GRUNDFOS Pumps (Shanghai) Co. Ltd.
50/F Maxdo Center No. 8 XingYi Rd.
Hongqiao development Zone
Shanghai 200336
PRC
Phone: +86 21 612 252 22
Telefax: +86 21 612 253 33

Croatia

GRUNDFOS CROATIA d.o.o.
Buzinski prilaz 38, Buzin
HR-10010 Zagreb
Phone: +385 1 6595 400
Telefax: +385 1 6595 499
www.hr.grundfos.com

Czech Republic

GRUNDFOS s.r.o.
Čajkovského 21
779 00 Olomouc
Phone: +420-585-716 111
Telefax: +420-585-716 299

Denmark

GRUNDFOS DK A/S
Martin Bachs Vej 3
DK-8850 Bjerringbro
Tlf.: +45-87 50 50 50
Telefax: +45-87 50 51 51
E-mail: info_GDK@grundfos.com
www.grundfos.com/DK

Estonia

GRUNDFOS Pumps Eesti OÜ
Peterburi tee 92G
11415 Tallinn
Tel: + 372 606 1690
Fax: + 372 606 1691

Finland

OY GRUNDFOS Pumput AB
Mestarintie 11
FIN-01730 Vantaa
Phone: +358-(0)207 889 900
Telefax: +358-(0)207 889 550

France

Pompes GRUNDFOS Distribution S.A.
Parc d'Activités de Chesnes
57, rue de Malacombe
F-38290 St. Quentin Fallavier (Lyon)
Tél.: +33-4 74 82 15 15
Télécopie: +33-4 74 94 10 51

Germany

GRUNDFOS GMBH
Schlüterstr. 33
40699 Erkrath
Tel.: +49-(0) 211 929 69-0
Telefax: +49-(0) 211 929 69-3799
e-mail: infoservice@grundfos.de
Service in Deutschland:
e-mail: kundendienst@grundfos.de

HILGE GmbH & Co. KG

Hilgestrasse 37-47
55292 Bodenheim/Rhein
Germany
Tel.: +49 6135 75-0
Telefax: +49 6135 1737
e-mail: hilge@hilge.de

Greece

GRUNDFOS Hellas A.E.B.E.
20th km. Athinon-Markopoulou Av.
P.O. Box 71
GR-19002 Peania
Phone: +0030-210-66 83 400
Telefax: +0030-210-66 46 273

Hong Kong

GRUNDFOS Pumps (Hong Kong) Ltd.
Unit 1, Ground floor
Siu Wai Industrial Centre
29-33 Wing Hong Street &
68 King Lam Street, Cheung Sha Wan
Kowloon
Phone: +852-27861706 / 27861741
Telefax: +852-27858664

Hungary

GRUNDFOS Hungária Kft.
Park u. 8
H-2045 Törökbálint,
Phone: +36-23 511 110
Telefax: +36-23 511 111

India

GRUNDFOS Pumps India Private Limited
118 Old Mahaballipuram Road
Thoraiakkam
Chennai 600 096
Phone: +91-44 2496 6800

Indonesia

PT GRUNDFOS Pompa
Jl. Rawa Sumur III, Blok III / CC-1
Kawasan Industri, Pulogadung
Jakarta 13930
Phone: +62-21-460 6909
Telefax: +62-21-460 6910 / 460 6901

Ireland

GRUNDFOS (Ireland) Ltd.
Unit A, Merrywell Business Park
Ballymount Road Lower
Dublin 12
Phone: +353-1-4089 800
Telefax: +353-1-4089 830

Italy

GRUNDFOS Pompe Italia S.r.l.
Via Gran Sasso 4
I-20060 Truccazzano (Milano)
Tel.: +39-02-95838112
Telefax: +39-02-95309290 / 95838461

Japan

GRUNDFOS Pumps K.K.
Gotanda Metalion Bldg., 5F,
5-21-15, Higashi-gotanda
Shiagawa-ku, Tokyo
141-0022 Japan
Phone: +81 35 448 1391
Telefax: +81 35 448 9619

Korea

GRUNDFOS Pumps Korea Ltd.
6th Floor, Aju Building 679-5
Yeoksam-dong, Kangnam-ku, 135-916
Seoul, Korea
Phone: +82-2-5317 600
Telefax: +82-2-5633 725

Latvia

SIA GRUNDFOS Pumps Latvia
Deglava biznesa centrs
Augusta Deglava ielā 60, LV-1035, Rīga,
Tālr.: + 371 714 9640, 7 149 641
Fakss: + 371 914 9646

Lithuania

GRUNDFOS Pumps UAB
Smolensko g. 6
LT-03201 Vilnius
Tel: + 370 52 395 430
Fax: + 370 52 395 431

Malaysia

GRUNDFOS Pumps Sdn. Bhd.
7 Jalan Peguam U1/25
Glenmarie Industrial Park
40150 Shah Alam
Selangor
Phone: +60-3-5569 2922
Telefax: +60-3-5569 2866

Mexico

Bombas GRUNDFOS de México S.A. de
C.V.
Boulevard TLC No. 15
Parque Industrial Stiva Aeropuerto
Apodaca, N.L. 66600
Phone: +52-81-8144 4000
Telefax: +52-81-8144 4010

Netherlands

GRUNDFOS Netherlands
Veluwezoom 35
1326 AE Almere
Postbus 22015
1302 CA ALMERE
Tel.: +31-88-478 6336
Telefax: +31-88-478 6332
E-mail: info_gnl@grundfos.com

New Zealand

GRUNDFOS Pumps NZ Ltd.
17 Beatrice Tinsley Crescent
North Harbour Industrial Estate
Albany, Auckland
Phone: +64-9-415 3240
Telefax: +64-9-415 3250

Norway

GRUNDFOS Pumper A/S
Stramsveien 344
Postboks 235, Leirdal
N-1011 Oslo
Tlf.: +47-22 90 47 00
Telefax: +47-22 32 21 50

Poland

GRUNDFOS Pompy Sp. z o.o.
ul. Klonowa 23
Baranowo k. Poznania
PL-62-081 Przemierowo
Tel: (+48-61) 650 13 00
Fax: (+48-61) 650 13 50

Portugal

Bombas GRUNDFOS Portugal, S.A.
Rua Calvet de Magalhães, 241
Apartado 1079
P-2770-153 Paço de Arcos
Tel.: +351-21-440 76 00
Telefax: +351-21-440 76 90

Romania

GRUNDFOS Pompe România SRL
Bd. Biruintei, nr 103
Pantelimon county Ilfov
Phone: +40 21 200 4100
Telefax: +40 21 200 4101
E-mail: romania@grundfos.ro

Russia

ООО Грундфос Россия
109544, г. Москва, ул. Школьная, 39-41,
стр. 1
Тел. (+7) 495 564-88-00 (495) 737-30-00
Факс (+7) 495 564 88 11
E-mail grundfos.moscow@grundfos.com

Serbia

Grundfos Srbija d.o.o.
Omladinskih brigada 90b
11070 Novi Beograd
Phone: +381 11 2258 740
Telefax: +381 11 2281 769
www.rs.grundfos.com

Singapore

GRUNDFOS (Singapore) Pte. Ltd.
25 Jalan Tukang
Singapore 619264
Phone: +65-6681 9688
Telefax: +65-6681 9689

Slovakia

GRUNDFOS s.r.o.
Prievozská 4D
821 09 BRATISLAVA
Phona: +421 2 5020 1426
sk.grundfos.com

Slovenia

GRUNDFOS d.o.o.
Štandrova 8b, SI-1231 Ljubljana-Črnuče
Phone: +386 31 718 808
Telefax: +386 (0)1 5680 619
E-mail: slovenia@grundfos.si

South Africa

GRUNDFOS (PTY) LTD
Corner Mountjoy and George Allen Roads
Wilbart Ext. 2
Bedfordview 2008
Phone: (+27) 11 579 4800
Fax: (+27) 11 455 6066
E-mail: lsmart@grundfos.com

Spain

Bombas GRUNDFOS España S.A.
Camino de la Fuentequilla, s/n
E-28110 Algete (Madrid)
Tel.: +34-91-848 8800
Telefax: +34-91-628 0465

Sweden

GRUNDFOS AB
Box 333 (Lunnagårdsgatan 6)
431 24 Mölndal
Tel.: +46 31 332 23 000
Telefax: +46 31 331 94 60

Switzerland

GRUNDFOS Pumpen AG
Bruggacherstrasse 10
CH-8117 Fällanden/ZH
Tel.: +41-44-806 8111
Telefax: +41-44-806 8115

Taiwan

GRUNDFOS Pumps (Taiwan) Ltd.
7 Floor, 219 Min-Chuan Road
Taichung, Taiwan, R.O.C.
Phone: +886-4-2305 0868
Telefax: +886-4-2305 0878

Thailand

GRUNDFOS (Thailand) Ltd.
92 Chaloom Phrakiat Rama 9 Road,
Dokmai, Pravej, Bangkok 10250
Phone: +66-2-725 8999
Telefax: +66-2-725 8998

Turkey

GRUNDFOS POMPA San. ve Tic. Ltd. Sti.
Gebze Organize Sanayi Bölgesi
Ihsan dede Caddesi,
2. yol 200. Sokak No. 204
41490 Gebze/ Kocaeli
Phone: +90 - 262-679 7979
Telefax: +90 - 262-679 7905
E-mail: satis@grundfos.com

Ukraine

Бізнес Центр Європа
Столичне шосе, 103
м. Київ, 03131, Україна
Телефон: (+38 044) 237 04 00
Факс.: (+38 044) 237 04 01
E-mail: ukraine@grundfos.com

United Arab Emirates

GRUNDFOS Gulf Distribution
P.O. Box 16768
Jebel Ali Free Zone
Dubai
Phone: +971 4 8815 166
Telefax: +971 4 8815 136

United Kingdom

GRUNDFOS Pumps Ltd.
Grovebury Road
Leighton Buzzard/Beds. LU7 4TL
Phone: +44-1525-850000
Telefax: +44-1525-850011

U.S.A.

GRUNDFOS Pumps Corporation
17100 West 118th Terrace
Olathe, Kansas 66061
Phone: +1-913-227-3400
Telefax: +1-913-227-3500

Uzbekistan

Grundfos Tashkent, Uzbekistan The Repre-
sentative Office of Grundfos Kazakhstan in
Uzbekistan
38a, Oybek street, Tashkent
Телефон: (+998) 71 150 3290 / 71 150
3291
Факс: (+998) 71 150 3292

Addresses Revised 21.05.2014

98393513 1114

ECM: 1146539
