

Modbus for Grundfos pumps

CIM/CIU 200 Modbus RTU

CIM/CIU 250 GSM/GPRS

CIM/CIU 500 Ethernet for Modbus TCP

Functional profile and user manual



English (GB) Functional profile and user manual

Original functional profile and user manual.

This functional profile describes Grundfos Modbus for pumps.

CONTENTS

	Page		
1. General information	3	13.3	Read input registers, 0x04 37
1.1 Hazard statements	3	13.4	Write single register, 0x06 37
1.2 Notes	3	13.5	Write multiple registers, 0x10 38
2. Introduction	4	13.6	Diagnostics, 0x08 38
2.1 About this functional profile	4	13.7	Diagnostics register interpretation 39
2.2 Assumptions	4	13.8	Diagnostics: Return query data 39
2.3 Definitions and abbreviations	4	13.9	Reading the CIM configuration register block 39
3. System description	5	13.10	Setting the setpoint 39
3.1 Modbus	5	13.11	Setting the control mode 40
3.2 Modbus RTU, CIM 200	5	13.12	Starting the E-pump 40
3.3 Modbus GSM/GPRS, CIM 250	5	13.13	Stopping the E-pump 40
3.4 Modbus TCP, CIM 500	5	14. Fault finding the product	41
4. Specifications	6	14.1	CIM/CIU 200 41
4.1 CIM module	6	14.2	CIM/CIU 250 43
4.2 CIM 200 Modbus RTU	6	14.3	CIM/CIU 500 45
4.3 CIM 250 GSM/GPRS	7	15. Modbus RTU rotary switch addresses	47
4.4 CIM 500 Modbus TCP	7		
5. Modbus RTU, CIM 200 setup	8		
5.1 Setting the Modbus transmission speed	8		
5.2 Setting the parity	9		
5.3 Modbus address selection	9		
5.4 Termination resistor	9		
5.5 Status LEDs	10		
6. Modbus GSM/GPRS, CIM 250 setup	11		
6.1 Installation	11		
6.2 Status LEDs	12		
7. Modbus TCP, CIM 500 setup	13		
7.1 Connecting the ethernet cable	13		
7.2 Setting the Industrial Ethernet protocol	13		
7.3 Setting the IP addresses	13		
7.4 Establish a connection to the webserver	14		
7.5 Status LEDs	14		
7.6 DATA and LINK LEDs	14		
8. Modbus function code overview	15		
9. Modbus register addresses	16		
9.1 Register block overview	16		
9.2 CIM configuration register block	16		
9.3 CIM status register block	18		
9.4 GSM real time clock	18		
9.5 Pump control register block	19		
9.6 Pump status register block	21		
9.7 Pump data register block	24		
9.8 Sensor-dependent measurements	26		
9.9 Alarm simulation register block (not CUE)	27		
10. Detailed descriptions of registers	28		
10.1 Control mode	28		
10.2 Setpoint in closed-loop control	29		
10.3 Setpoint in open-loop control	29		
10.4 Alarms and warnings	30		
11. Modbus RTU commissioning, step-by-step guides	31		
11.1 Hardware setup, CIM 200	31		
11.2 Hardware setup, CIU 200	31		
11.3 Hardware setup, CIM 250 GSM call-up	31		
11.4 Hardware setup, CIU 250 GSM call-up	32		
11.5 Hardware setup, CIM 250 GPRS connection	32		
11.6 Hardware setup, CIU 250 GPRS connection	32		
11.7 Modbus TCP communication setup, CIM 500	33		
11.8 Modbus TCP communication setup, CIU 500	33		
12. Detailed descriptions of functionality	34		
12.1 GSM	34		
12.2 GPRS	34		
13. Modbus RTU telegram examples	37		
13.1 Modbus telegram overview	37		
13.2 Read holding registers, 0x03	37		



Read this document before installing the product. Installation and operation must comply with local regulations and accepted codes of good practice.

1. General information

1.1 Hazard statements

The symbols and hazard statements below may appear in Grundfos installation and operating instructions, safety instructions and service instructions.



DANGER

Indicates a hazardous situation which, if not avoided, will result in death or serious personal injury.



WARNING

Indicates a hazardous situation which, if not avoided, could result in death or serious personal injury.



CAUTION

Indicates a hazardous situation which, if not avoided, could result in minor or moderate personal injury.

The hazard statements are structured in the following way:



SIGNAL WORD

Description of hazard

Consequence of ignoring the warning.

- Action to avoid the hazard.

1.2 Notes

The symbols and notes below may appear in Grundfos installation and operating instructions, safety instructions and service instructions.



Observe these instructions for explosion-proof products.



A blue or grey circle with a white graphical symbol indicates that an action must be taken.



A red or grey circle with a diagonal bar, possibly with a black graphical symbol, indicates that an action must not be taken or must be stopped.



If these instructions are not observed, it may result in malfunction or damage to the equipment.



Tips and advice that make the work easier.

2. Introduction

2.1 About this functional profile

This functional profile describes the following modules and units:

- CIM/CIU 200 Modbus RTU
- CIM/CIU 250 Modbus GSM/GPRS
- CIM/CIU 500 Modbus ethernet for Modbus TCP.

This functional profile applies to the following Grundfos products:

- Grundfos CRE/CRNE/CRIE, MTRE, CHIE, CME
- Grundfos TPE, TPE Series 2000, NBE/NKE
- Grundfos CUE drive
- Grundfos MAGNA (with add-on GENIbus module)
- Grundfos MAGNA3
- Grundfos UPE Series 2000 (UPE 80-120 and 100-120).

In the following, the supported products are referred to as "E-pumps".

Grundfos cannot be held responsible for any problems caused directly or indirectly by using information in this functional profile.

2.2 Assumptions

This functional profile assumes that the reader is familiar with commissioning and programming of Modbus devices. The reader should also have some basic knowledge of the Modbus protocol and technical specifications.

It is also assumed that an existing Modbus network with a Modbus master is present.

2.3 Definitions and abbreviations

3G	Third-generation mobile telephony network.
4G	Fourth-generation mobile telephony network.
ARP	Address Resolution Protocol. Translates IP addresses into MAC addresses.
Auto-MDIX	Ensures that both crossover cable types and non-crossover cable types can be used.
CAT5	Ethernet cable with four twisted pairs of wires.
CAT5e	Enhanced CAT5 cable with better performance.
CAT6	Ethernet cable compatible with CAT5 and CAT5e and with very high performance.
CIM	Communication Interface Module.
CIU	Communication Interface Unit.
CRC	Cyclic Redundancy Check. A data error detection method.
DHCP	Dynamic Host Configuration Protocol. Used to configure network devices so that they can communicate on an IP network.
DNS	Domain Name System. Used to resolve host names to IP addresses.
GENIbus	Proprietary Grundfos fieldbus standard.
GENIpro	Proprietary Grundfos fieldbus protocol.
GPRS	General Packet Radio Service. Technology for TCP/IP communication and internet access via GSM.
Grundfos GO Remote	A Grundfos application designed to control Grundfos products via infrared or radio communication. Available for iOS and Android devices.
GSM	Global System for Mobile communications.
H	Head (pressure).
HTTP	Hyper Text Transfer Protocol. The protocol commonly used to navigate the world wide web.
IANA	Internet Assigned Numbers Authority.
IP	Internet Protocol.

LED	Light-Emitting Diode
MAC	Media Access Control. Unique network address for a piece of hardware.
Modbus	A serial communications protocol commonly used in industry and building automation systems.
Modbus RTU	Modbus is a fieldbus used worldwide. The RTU version is used for wired networks, CIM 200, and for call-up connections over telephone networks, CIM 250.
Modbus TCP	Modbus is a fieldbus used worldwide. The TCP version is adapted for use as an application protocol on TCP/IP using either GPRS, CIM 250 or ethernet, CIM 500 as basis.
PIN	Personal Identification Number. For SIM cards.
Ping	Packet InterNet Groper. A software utility that tests the connectivity between two TCP/IP hosts.
PUK	Personal Unblocking Key. For SIM cards.
Q	Flow rate.
SELV	Separated or Safety Extra-Low Voltage.
SELV-E	Separated or Safety Extra-Low Voltage with earth connection.
SIM	Subscriber Identity Module. SIM card.
SMA	SubMiniature version A. Coaxial radio signal cable connection standard.
SMTP	Simple Mail Transfer Protocol.
SNTP	Simple Network Time Protocol. Used for clock synchronisation between computer systems.
TCP	Transmission Control Protocol. Protocol for Internet communication and Industrial Ethernet communication.
TCP/IP	Transmission Control Protocol/Internet Protocol. Protocol for Internet communication.
Transmission speed	Bits transferred per second, bits/s.
URL	Uniform Resource Locator. The IP address used to connect to a server.
UTC	Coordinated Universal Time. The primary time standard by which the world regulates clocks and time.
UTF-8	Unicode Transformation Format. Character encoding.
VPN	Virtual Private Network. A network using the Internet to connect nodes. These systems use encryption and other security mechanisms to ensure that only authorised users can access the network and that the data cannot be intercepted.

3. System description

3.1 Modbus

The system diagrams provide an overview for the different technologies of how to connect the module or unit to the Grundfos E-pump that you connect to a Modbus network.

CIM solution

The Communication Interface Module (CIM) is an add-on communication module you install internally in a Grundfos E-pump, using a 10-pin connection. In this setup, the E-pump will supply power to CIM 200. See fig. 1.

For mounting of the CIM add-on module, see the installation and operating instructions for the E-pump in question.

CIU solution

The Communication Interface Unit (CIU) is a box with a power supply module and a CIM Modbus module. You can mount either on a DIN rail or on a wall.

You use it in conjunction with Grundfos E-pumps that do not support an internal, add-on communication module, CIM. See fig. 2.

3.2 Modbus RTU, CIM 200



TM05 2934 1013

Fig. 1 Principle sketch of CIM 200 Modbus RTU solution with add-on CIM module installed inside the pump. The figure shows a MAGNA3 pump

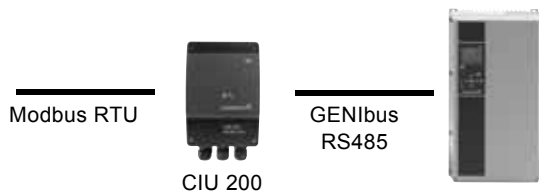

TM05 7439 1013

Fig. 2 Principle sketch of CIU 200 Modbus RTU solution. The figure shows a CUE-drive for pumps

The module and unit is connected as a Modbus slave directly to the Modbus network.

3.3 Modbus GSM/GPRS, CIM 250

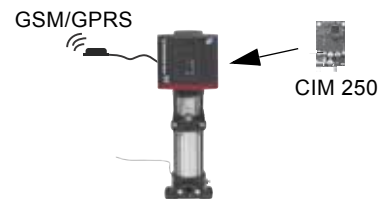

TM04 9232 3610

Fig. 3 Principle sketch of CIM 250 Modbus GSM/GPRS solution with internal add-on CIM module and external antenna. The figure shows a CRE pump

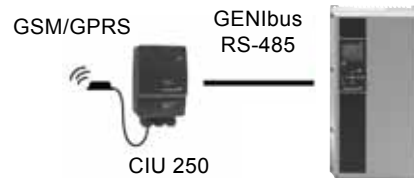

TM04 9232 3610

Fig. 4 Principle sketch of CIU 250 Modbus GSM/GPRS solution with external antenna. The figure shows a CUE-drive for pumps



3G/4G are not supported via CIM 250.

3.4 Modbus TCP, CIM 500

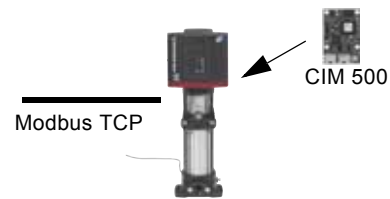

TM05 7431 1013

Fig. 5 Principle sketch of CIM 500 Modbus TCP solution with internal add-on module. The figure shows a CRE pump

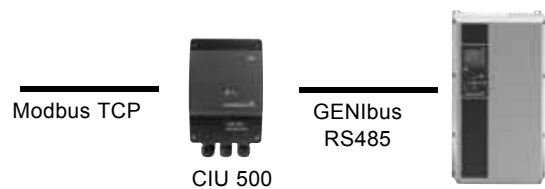

TM05 7452 1013

Fig. 6 Principle sketch of CIU 500 Modbus TCP solution. The figure shows a CUE drive for pumps

4. Specifications

4.1 CIM module

General data	Description	Comments
Ambient humidity	30-95 %	Relative, non-condensing.
Operating temperature	-20 °C to +45 °C	
Storage temperature	-25 °C to +70 °C	
Battery, lithium-ion	You can only charge the battery if the battery temperature is within 0 -45 °C.	CIM 250 only.
GENIbus visual diagnostics	LED2	The LED will be in one of these states: Off, permanently green, flashing red, permanently red. See section 5.5 Status LEDs .
Power supply (CIU)	24-240 V	Located in the unit.
GENIbus connection type (CIU)	RS-485, 3-wire + screen	Conductors: A, B and Y.
CIU box enclosure class	IP54	
CIU box dimensions (H x W x D)	182 x 108 x 82 mm	

4.2 CIM 200 Modbus RTU

The table below provides an overview of the specifications for Grundfos CIM 200 and CIU 200. For further details, please refer to the specific sections of this functional profile.

Modbus RTU specifications	Description	Comments
Modbus connector	Screw-type terminal	3 pins. See section 5. Modbus RTU, CIM 200 setup .
Modbus connection type	RS-485, 2-wire + common	Conductors: D0, D1 and Common. See section 5. Modbus RTU, CIM 200 setup .
Maximum cable length	1200 m	Equals 4000 ft.
Slave address	1-247	Set via rotary switches SW6 and SW7. See section 5.3 Modbus address selection .
Line termination	On or Off	Set via DIP switches SW1 and SW2. See section 5.4 Termination resistor .
Recommended cable-cross	0.20 - 0.25 mm ²	AWG24 or AWG23
Supported transmission speeds	1200*, 2400*, 4800*, 9600, 19200, 38400 bits/s	Set via DIP switches SW4 and SW5. See section 5.1 Setting the Modbus transmission speed .
Start bit	1	Fixed value.
Data bits	8	Fixed value.
Stop bits	1 or 2	Set via DIP switch SW3. See section 5.2 Setting the parity .
Parity bit	Even parity, odd parity* or no parity	Set via DIP switch SW3. See section 5.2 Setting the parity .
Modbus visual diagnostics	LED1	Off, flashing green, flashing red, permanently red. See section 5.5 Status LEDs .
Maximum number of Modbus devices	32	Using repeaters, you can increase this number. Legal address range is 1-247.
Maximum Modbus telegram size	256 bytes	Total length. Node address and CRC included. See section 13. Modbus RTU telegram examples .

* Can only be set via software.

4.3 CIM 250 GSM/GPRS

The table below provides an overview of the specifications for Grundfos CIM/CIU 250. For further details, please refer to the specific sections of this functional profile.

Modbus GSM/GPRS specifications	Description	Comments
Data protocol	Modbus RTU/Modbus TCP	GSM call-up uses RTU. GPRS uses TCP.
Slave address	Factory 231 (0xE7)	You can change the address via Modbus register 00003, SoftwareDefinedModbusAddress.
GSM/GPRS visual diagnostics	LED1	See section 6.2 Status LEDs .
Maximum Modbus telegram size	260 bytes	Total Modbus TCP/IP application data unit. See fig. 24 .

4.4 CIM 500 Modbus TCP

The table below provides an overview of the specifications for Grundfos CIM/CIU 500 for Modbus TCP. For further details, please refer to the specific sections of this functional profile.

Modbus TCP specifications	Description	Comments
Application layer	DHCP, HTTP, Ping, FTP, SMTP, SNTP, Modbus TCP	Rotary switch in position 1.
Transport layer	TCP	
Internet layer	Internet protocol V4 (IPv4)	
Link layer	ARP, media access control (ethernet)	
Ethernet cable	CAT5, CAT5e or CAT6	Supports auto cable-crossover detecting (Auto-MDIX)
Maximum cable length	100 metres at 10/100 Mbits/s	Corresponds to 328 feet.
Transmission speed	10 Mbits/s, 100 Mbits/s	Auto-detected
Industrial Ethernet protocols	PROFINET IO, Modbus TCP	Selected with rotary switch, section 7.2 Setting the Industrial Ethernet protocol .

5. Modbus RTU, CIM 200 setup

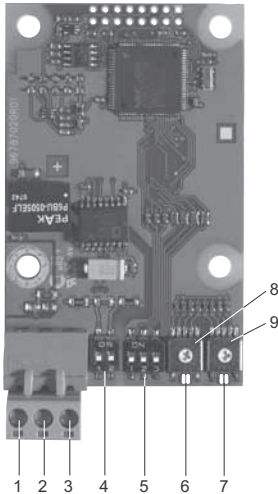

Fig. 7 CIM 200 Modbus module

Pos.	Designation	Description
1	D1	Modbus terminal D1 (positive data signal)
2	D0	Modbus terminal D0 (negative data signal)
3	Common/GND	Modbus terminal Common and GND
4	SW1/SW2	On and off switches for termination resistor
5	SW3/SW4/SW5	Switches for selection of Modbus parity and transmission speed
6	LED1	Red and green status LED for Modbus communication
7	LED2	Red and green status LED for internal communication between CIM/CIU 200 and the E-pump
8	SW6	Hexadecimal rotary switch for setting the Modbus address, four most significant bits
9	SW7	Hexadecimal rotary switch for setting the Modbus address, four least significant bits

Use a screened, twisted-pair cable. Connect the cable screen to protective earth at both ends.

Recommended connection

Modbus terminal	Colour code	Data signal
D1-TXD1	Yellow	Positive
D0-TXD0	Brown	Negative
Common/GND	Grey	Common/GND

5.1 Setting the Modbus transmission speed

Set the transmission speed correctly before the CIM 200 Modbus module is ready to communicate with the Modbus network. Use DIP switches SW4 and SW5 for setting the transmission speed. See fig. 8.

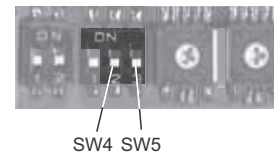

Fig. 8 Modbus transmission speed

DIP switch settings

Available transmission speeds in bits/s: 1200, 2400, 4800, 9600, 19200 and 38400.

The first three transmission speeds are only available via software settings, whereas the last three are available via DIP switches.

Transmission speed [bits/s]	SW4	SW5
9600	OFF	ON
19200	OFF	OFF
38400	ON	OFF
Software-defined	ON	ON

Default transmission speed is 19200 bits per second, as per the Modbus RTU standard.

Software-defined

When SW4 and SW5 are set to "software-defined", writing a value to the holding register at address 00004 will set a new transmission speed.

Use the following values for software-defined transmission speeds:

Software-defined transmission speed	Value to set in register 00004
1200 bits/s	0
2400 bits/s	1
4800 bits/s	2
9600 bits/s	3
19200 bits/s	4
38400 bits/s	5

This value is set to 1200 bits/s as default.

The communication interface does not support transmission speeds above 38400 bits/s.

The software-defined transmission speed value is stored in the communication interface and remains after a power-off.

TM04 1697 0908

TM04 1710 0908

5.2 Setting the parity



When software-defined transmission speed is enabled (ON), software-defined parity and stop bits are also enabled.

You can set the parity either manually by using SW3 or via software-defined settings.

Manual setting of parity

Default byte format (11 bits):

- 1 start bit
- 8 data bits (least significant bit sent first)
- 1 parity bit (even parity)
- 1 stop bit.

The default setting of the CIM 200 Modbus module is even parity (1 stop bit). It is possible to change the parity using DIP switch SW3. You can change the parity to no parity (2 stop bits). See fig. 9.

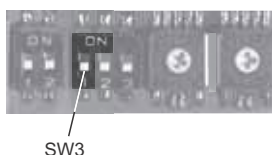

Fig. 9 Parity

DIP switch settings

Parity	SW3
Even parity, 1 stop bit	OFF
No parity, 2 stop bits	ON

Software-defined parity and stop bits

When SW4 and SW5 are set to "software-defined", the value in the holding registers at addresses 00009 and 00010 will override the setting of SW3. See figs. 8 and 9.

Software-defined parity	Value to set in register 00009
No parity [default]	0
Even parity	1
Odd parity	2

Software-defined stop bit	Value to set in register 00010
1 stop bit [default]	1
2 stop bits	2

The software-defined parity and stop bit values are stored in the communication interface and remains after a power-off.



Before you can set the parity and stop bits via software-defined settings, you must set SW4 and SW5 to ON.

5.3 Modbus address selection

A Modbus slave on a Modbus network must have a unique address from 1-247. Address 0 is reserved for broadcasting, and is not a valid slave address.

To set the Modbus address, use two hexadecimal rotary switches (SW6 and SW7). See fig. 10.

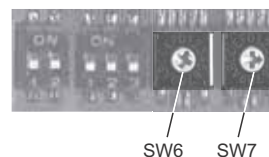

Fig. 10 Setting the Modbus address

For a complete overview of Modbus addresses, see section 14. [Fault finding the product.](#)



You must set the Modbus address decimally from 1 to 247.

5.4 Termination resistor

The termination resistor is fitted on CIM 200 Modbus and has a value of 150 Ω.

CIM 200 has a DIP switch with two switches, SW1 and SW2, for cutting the termination resistor in and out. Fig. 11 shows the DIP switches in cut-out state.

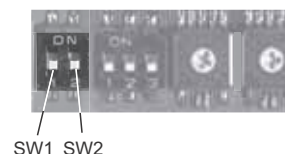

Fig. 11 Cutting the termination resistor in and out

DIP switch settings

Status	SW1	SW2
Cut in	ON	ON
	OFF	OFF
Cut out	ON	OFF
	OFF	ON

Default setting: Termination resistor cut out.

Cable length

We recommend the following maximum lengths:

Bits/s	Maximum cable length	
	Terminated cable	Unterminated cable
	[m/ft]	[m/ft]
1200-9600	1200/4000	1200/4000
19200	1200/4000	500/1700
38400	1200/4000	250/800



To ensure a stable and reliable communication, it is important that only the termination resistor of the first and last units in the Modbus network are cut in.



All switch settings will be effective immediately after setting the values. No power-off is needed.

5.5 Status LEDs

CIM 200 Modbus has two LEDs. See fig. 7.

- Red and green status LED (LED1) for Modbus communication
- Red and green status LED (LED2) for internal communication between CIM 200 and the Grundfos product.

LED1

Status	Description
Off	No Modbus communication.
Flashing green	Modbus communication active.
Flashing red	Fault in the Modbus communication.
Permanently red	Fault in the CIM 200 Modbus configuration.

LED2

Status	Description
Off	CIM 200 has been switched off.
Flashing red	No internal communication between CIM 200 and the Grundfos product.
Permanently red	CIM 200 does not support the Grundfos product connected.
Permanently green	Internal communication between CIM 200 and the Grundfos product is OK.



During startup, there may be a delay of up to 5 seconds before the LED2 status is updated.

6. Modbus GSM/GPRS, CIM 250 setup

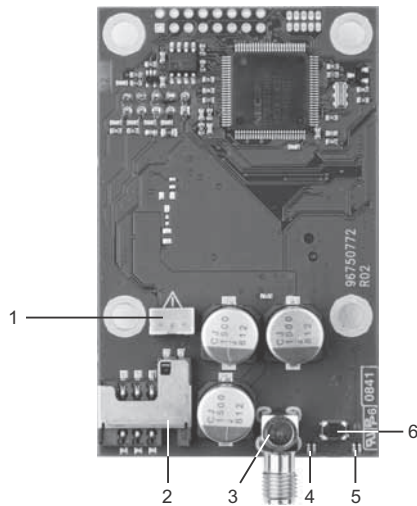

TM04 2642 1210

Fig. 12 CIM 250 GSM module (top-side view)

Pos.	Designation	Description
1		Battery socket
2		SIM card holder
3		SMA connection for GSM antenna
4	LED1	Yellow and green status LED for GSM/GPRS communication
5	LED2	Red and green status LED for internal communication between CIU 250 and the pump
6	SW1	Reset button. Keep the button pressed for 5 seconds to return to default settings.

6.1 Installation

WARNING

Electric shock



Death or serious personal injury
- Before installation, make sure that the power supply has been switched off and that it cannot be accidentally switched on.

6.1.1 Fitting a GSM antenna

An antenna must be connected to CIM 250 to establish connection to the GSM network.



If CIU 250 is installed in a metal control cabinet, we recommend fitting an external GSM antenna. Grundfos offers different kinds of antennas. No antenna is supplied with CIU 250. You can order it separately.

External antenna

Connect the antenna cable to the SMA connection (pos. 1) of CIM 250. The antenna must be installed outside the control cabinet in a position with good reception conditions.

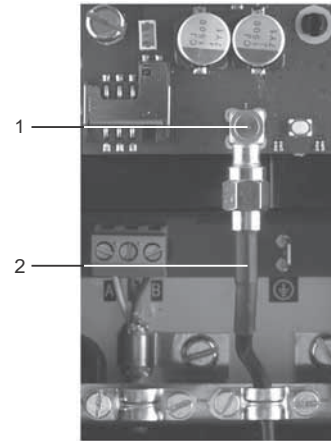

TM04 2644 2808

Fig. 13 Fitting an external GSM antenna

Pos.	Description
1	SMA connection for GSM antenna
2	Antenna cable for external GSM antenna

6.1.2 Inserting the SIM card

Before inserting the SIM card into CIM 250, remove the PIN code, or set the PIN code to "4321".

Procedure

1. Insert the SIM card into a mobile phone.
2. Remove the PIN code from the SIM card, or set the PIN code to "4321". See the manual of the mobile phone.
3. Insert the SIM card into CIM 250. See fig. 14.



The slanted edge of the SIM card must point downwards, away from the connector.

The connectors on the SIM card must face inwards towards CIM 250. See fig. 14.

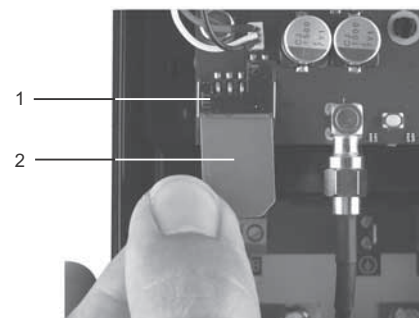

TM04 2643 2808

Fig. 14 Inserting the SIM card

Pos.	Description
1	SIM card holder
2	SIM card

6.1.3 Connecting the battery and power supply



WARNING

Electric shock

- Death or serious personal injury
- Connect CIM 250 only to SELV or SELV-E circuits.

WARNING

Flammable material

- Death or serious personal injury
- Only insert the approved Grundfos battery pack (97631960).
 - Never use this battery pack in other battery chargers.
 - Do not dismantle or modify the battery.
 - Do not heat or incinerate the battery.
 - Do not pierce, crush or cause mechanical damage to the battery.
 - Do not short-circuit the battery.
 - Do not allow the battery to get wet or be immersed in water.
 - Do not strike or throw the battery.
 - For long periods of storage, the temperature must be below 45 °C.



You can fit CIM 250 with a lithium-ion battery (order no. 97631960), which will ensure sustained GSM/GPRS connection with the product in which it is mounted, even if the power is switched off. The battery is secured by a velcro strap which absorbs vibrations and simplifies replacement. Connect the battery to CIM 250 as shown in fig. 15.



If a battery is not connected, the user will not receive any SMS alarm message in case of a power cut.

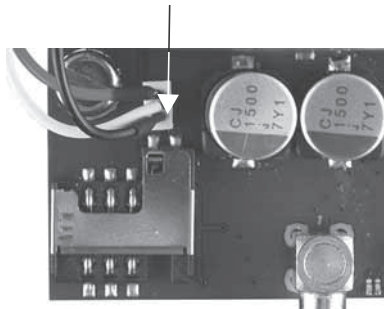

Fig. 15 Connecting the battery



You can only charge the battery if the battery temperature is within 0 to 45 °C.

Switch on the power supply. CIM 250 is powered either by CIU 250 or by the battery.

The LED1 flashes yellow (searching for GSM network). When the connection to the GSM network has been established, the LED1 will pulsate yellow (GSM network active). See fig. 16.

The LED2 must be permanently green, indicating that CIM 250 has been fitted correctly in CIU 250.

6.1.4 Configuration

For software configuration of CIU 250, which includes setting of SMS functions and SCADA communication parameters, see "CIM 25X SMS commands", supplement to the installation and operating instructions, on the CD-ROM supplied with the GSM module.

6.2 Status LEDs

The CIM 250 GSM module has two LEDs. See fig. 12.

- Yellow and green status LED (LED1) for GSM/GPRS communication.

Red and green status LED (LED2) for internal communication between CIM 250 and the E-pump.

LED1 (yellow and green)

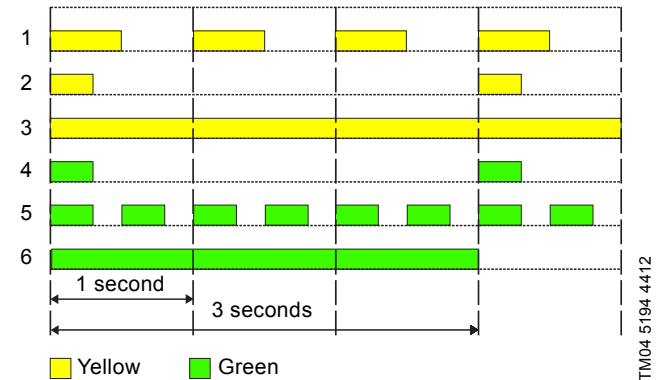

Fig. 16 LED1 status

Pos.	Status	Description
1	Flashing yellow	Searching for GSM network.
2	Pulsating yellow, single pulse	Connection to the GSM network has been established.
3	Permanently yellow	Call-up connection has been established.
4	Pulsating green, single pulse	Data are exchanged via GPRS.
5	Pulsating green, double pulse	Data are exchanged via the call-up connection.
6	Green (3 sec.)	Sending or receiving an SMS message.

LED2 (red and green)

Status	Description
Off	CIM 250 has been switched off.
Flashing red	No communication between CIM 250 and the E-pump.
Permanently red	CIM 250 does not support the connected version of the E-pump.
Permanently green	The connection between CIM 250 and the E-pump is OK.

TM04 2645 2808

TM04 5194 4412

7. Modbus TCP, CIM 500 setup



WARNING

Electric shock

Death or serious personal injury
 - Connect CIM 500 only to SELV or SELV-E circuits.

7.1 Connecting the ethernet cable

Use RJ45 plugs and ethernet cable. Connect the cable shield to protective earth at both ends.



It is important to connect the cable shield to earth through an earth clamp or to connect the cable shield to earth in the connector.

CIM 500 is designed for flexible network installation; the built-in two port switch makes it possible to daisy chain from product to product without the need of additional ethernet switches. The last product in the chain is only connected to one of the ethernet ports. Each ethernet port has its own MAC address.

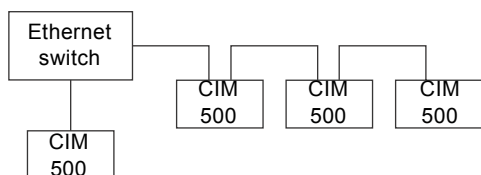

Fig. 17 Example of Industrial Ethernet network

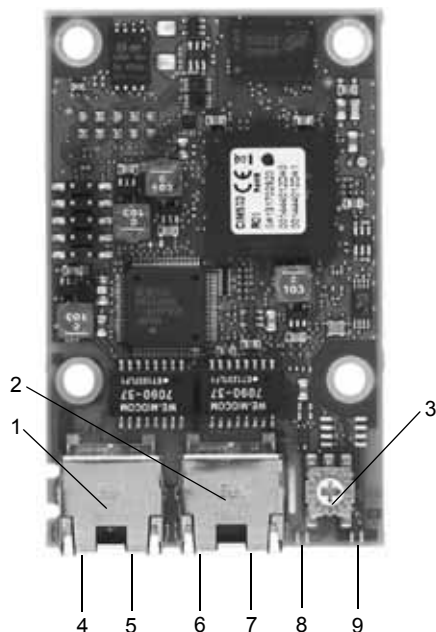

Fig. 18 Example of ethernet connection

Pos.	Description	Designation
1	Industrial Ethernet RJ45 connector 1	ETH1
2	Industrial Ethernet RJ45 connector 2	ETH2
3	Rotary switch for protocol selection	SW1
4	Data activity LED for connector 1	DATA1
5	Link LED for connector 1	LINK1
6	Data activity LED for connector 2	DATA2
7	Link LED for connector 2	LINK2
8	Green and red status LED for ethernet communication	LED 1
9	Green and red status LED for internal communication between the module and the pump.	LED 2

7.2 Setting the Industrial Ethernet protocol

The CIM 500 ethernet module has a rotary switch for selection of the Industrial Ethernet protocol. See fig. 19.



Fig. 19 Selecting the Industrial Ethernet protocol

Pos.	Description
0	PROFINET IO (default)
1	Modbus TCP
2	BACnet IP
3	EtherNet/IP
4	GRM IP (requires a contract with Grundfos)
5..E	Reserved, LED1 will be permanently red to indicate an invalid configuration
F	Reset to factory default Note: The rotary switch must be set in this position for 20 seconds to reset to factory default. During this period LED1 flashes red and green at the same time to indicate that a reset will occur.



Every change of the rotary switch while the module is powered on will cause the module to restart.

7.3 Setting the IP addresses

The CIM 500 ethernet module is default set to a fixed IP address. You can change the IP address settings from the built-in webserver.

Default IP settings used by the webserver	IP address: 192.168.1.100	Subnet mask: 255.255.255.0	Gateway: 192.168.1.1
IP settings for Modbus TCP	Make the settings via the webserver.		

TM05 6435 4711

TM05 7431 1013

TM05 7431 1013

7.4 Establish a connection to the webserver

You can configure CIM 500 using the built-in webserver. To establish a connection from a PC to CIM 500 the following steps are required:

- Connect the PC and CIM 500 using an ethernet cable.
- Configure the PC ethernet port to the same subnetwork as CIM 500, for example 192.168.1.101, and the subnet mask to 255.255.255.0. See section [A.1 How to configure an IP address on your PC](#) on page 51.
- Open a standard Internet browser and type 192.168.1.100 in the URL field.
- Log in to the webserver using the following:

User	admin (default)
Password	Grundfos (default)



User name and password may have been changed from their default values.



TM05 6436 4712

Fig. 20 CIM 500 connected to a PC via ethernet cable

For Further information on how to use the webserver, see section [A.2 Webserver configuration](#) on page 51.



You can use both ETH1 and ETH2 to establish a connection to the webserver.



You can access the webserver while the selected Industrial Ethernet protocol is active.

7.5 Status LEDs

The CIM 500 ethernet module has two status LEDs, (LED1 and LED2).

See fig. 18.

- Red and green status LED (LED1) for ethernet communication
- Red and green status LED (LED2) for internal communication between CIM 500 and the Grundfos product.

LED1

Status	Description
Off	No Modbus TCP communication or switched off.
Flashing green	Modbus TCP communication active.
Permanently red	CIM 500 module configuration fault. See section 14.3.1 LED status .
Permanently red and green	Error in the firmware download. See section 14.3.1 LED status .
Flashing red and green	Resetting to factory default. After 20 seconds, CIM 500 restarts.

LED2

Status	Description
Off	CIM 500 is switched off.
Flashing red	No internal communication between CIM 500 and the Grundfos product.
Permanently red	CIM 500 does not support the Grundfos product connected.
Permanently green	Internal communication between CIM 500 and the Grundfos product is OK.
Permanently red and green	Memory fault.



During startup, there is a delay of up to 5 seconds before LED1 and LED2 status is updated.

7.6 DATA and LINK LEDs

The CIM 500 ethernet module has two connectivity LEDs related to each RJ45 connector. See fig. 18.

DATA1 and DATA2

These yellow LEDs indicate data traffic activity.

Status	Description
Yellow off	No data communication on the RJ45 connector.
Yellow flashing	Data communication ongoing on the RJ45 connector.
Permanently yellow	Heavy network traffic on the RJ45 connector.

LNK1 and LNK2

These green LEDs show whether the ethernet cable is properly connected.

Status	Description
Green off	No ethernet link on the RJ45 connector.
Green on	Ethernet link on the RJ45 connector is OK.

8. Modbus function code overview

The supported function codes are shown in the table below:

Type	Code	Hex	Name
16-bit data (registers)	03	0x03	Read holding registers
	04	0x04	Read input registers
	06	0x06	Write single register
	16	0x10	Write multiple registers
Diagnostics	08	08	Diagnostics See section 13.6 Diagnostics, 0x08 for subcodes.



Reading or writing coils are not supported.

The same data are available in both holding registers and input registers, meaning that either function (0x03 or 0x04) can be used for reading data.



Unless otherwise stated, the data type used for counters and scaled values is always an unsigned integer.

9. Modbus register addresses

9.1 Register block overview

The Modbus RTU registers are grouped in the following register blocks:

Start address	Register block	Permissions	Description
00001	CIM configuration	R/W	Configuration of the CIM module.
00021	CIM status	R	Status registers for the CIM module.
00101	Pump control	R/W	Registers for control of the E-pump.
00201	Pump status	R	Registers for reading mode status from the E-pump.
00301	Pump data	R	Registers for reading measured data values from the E-pump.
00701	Alarm simulation	R/W	Registers for simulating alarms and warnings in the E-pump.

9.2 CIM configuration register block

Registers in this block can be read by means of function codes 0x03 and/or 0x04. They can be written as holding registers with function codes 0x06 and 0x10.

Address	Register name	Description	CIM 200	CIM 250	CIM 500
00001	SlaveMinimumReplyDelay	The minimum reply delay from the slave in ms. Value range: 0-10000, i.e. up to 10 seconds reply delay. This delay is typically used in conjunction with a radio modem. The delay value is stored in the device and remains after a power-off. The delay set here is added to the internal delay in the device. Default value is 0.	•	-	-
00002		RESERVED	•	•	•
00003	SoftwareDefinedModbusAddress	This register holds the active Modbus address. The default value is 0xE7 (231), and there is normally no need to change this value. Note: For CIM 200, this value is used only when you have set the transmission speed to "Software-defined" on DIP switches SW4 and SW5. Otherwise, the slave will ignore it.	•	•	-
00004	SoftwareDefinedBitRate	Modbus software-defined transmission speed enumeration. The software-defined transmission speed value is stored in the device and remains after a power-off. 0: 1200 bits/s 1: 2400 bits/s 2: 4800 bits/s 3: 9600 bits/s 4: 19200 bits/s 5: 38400 bits/s. Note: This value is used only when you have set the transmission speed to "Software-defined" on DIP switches SW4 and SW5. Otherwise, the slave will ignore it.	•	-	-
00005	AutoAckControlBits	Used to select the behaviour of control bit acknowledgements from the CIM/CIU. 0: Disabled. Control bits are not automatically lowered when accepted by the device. The user must lower the triggered control bit manually before the control bit can be triggered again. 1: Enabled. Control bits are automatically lowered when accepted by the device. The user does not have to lower it manually (default).	•	•	•
00006	ReadWriteSeparation	Not used.	-	-	-
00007	ScadaCallBackRegister	Not used.	-	-	-
00008	NoDataActivityTimeout	The elapsed time with no data activity before the module issues a "GPRS restart".	-	•	-
00009	SoftwareDefinedParity	Parity setting for use when using "software-defined" settings. 0: No parity (default) 1: Even parity 2: Odd parity. Note: For CIM 200, this value is used only when you have set the transmission speed to "Software-defined" on DIP switches SW4 and SW5. Otherwise, the slave will ignore it.	•	-	-

Address	Register name	Description	CIM 200	CIM 250	CIM 500
00010	SoftwareDefinedStopBit	<p>Stop bit setting for use when using "software-defined" settings.</p> <p>0: No stop bit 1: 1 stop bit (default) 2: 2 stop bits.</p> <p>Note: For CIM 200, this value is used only when you have set the transmission speed to "Software-defined" on DIP switches SW4 and SW5. Otherwise, the slave will ignore it.</p>	•	-	-
00011	ScadaPinCode	<p>PIN code for SCADA systems, etc.</p> <p>If GeneralStatus.ScadaPinCodeEnabled (register 00029, bit 0) is enabled, enter the correct PIN code in this register in order to gain access to remote control and configuration.</p> <p>Verify acceptance in GeneralStatus.WriteAccess (register 00029, bit 1). You programme the SCADA PIN code via the SMS command SETSCADACODE. See "CIM 25X SMS commands", supplement to the installation and operating instructions, on the CD-ROM supplied with the GSM module.</p>	-	•	-
00012	Watchdog	<p>Configuration of fieldbus communication watchdog.</p> <p>0: Watchdog is disabled (default) 1: Watchdog is enabled, timeout 5s. Any other value disables the watchdog. Watchdog action: The pump will be set to Local mode.</p> <p>CIM 200: Watchdog is fed whenever serial line data appears on the network. It is not a requirement that valid Modbus telegrams are preset nor that CIM 200 is specifically addressed. An interruption of serial data for more than 5 seconds activates the watchdog.</p> <p>CIM 500: Watchdog is only fed if CIM 500 is specifically addressed with Modbus TCP telegrams, matching IP address. If CIM 500 is connected to a Modbus TCP network but never gets addressed, it will activate watchdog after 5 seconds.</p>	•	-	•

9.3 CIM status register block

Registers in this block can be read by means of function codes 0x03 and/or 0x04. They are read-only. Use this block for various kinds of fault finding.

Address	Register name	Description	CIM 200	CIM 250	CIM 500
00021	GENIbusCRCErrorCnt	Holds a CRC error counter for the GENIbus connection to the E-pump.	•	•	•
00022	GENIbusDataErrorCnt	Holds a data error counter for the GENIbus connection to the E-pump.	•	•	•
00023	VersionNumber	A Grundfos-specific version number. This is an unsigned integer value.	•	•	•
00024	ActualModbusAddress	Holds the current Modbus slave address of the device. Valid value range: 1...247.	•	•	•
00025	GENIbusTXcountHI	Holds a transmit counter for the total number of telegrams sent to the E-pump on the GENIbus connection.	•	•	•
00026	GENIbusTXcountLO				
00027	GENIbusRXcountHI	Holds a receive counter for the total number of telegrams received from the E-pump on the GENIbus connection.	•	•	•
00028	GENIbusRXcountLO				
00029	GeneralStatus Bit 0: ScadaPinCodeEnabled	PIN code functionality. 0: No PIN code required. 1: PIN code required to perform remote control and configuration. Activation of SCADA PIN code protection takes place via the SMS command SCADACODE. See "CIM 25X SMS commands", supplement to the installation and operating instructions, on the CD-ROM supplied with the GSM module.	-	•	-
	GeneralStatus Bit 1: WriteAccess	Remote write access. 0: No write access (the PIN code is incorrect) 1: Full write access (the PIN code is either correct or not enabled).			
00030	UnitFamily	Grundfos product family.	•	•	•
00031	UnitType	Grundfos product type.	•	•	•
00032	UnitVersion	Grundfos product version.	•	•	•
00033	GSMBatteryState	State of GSM modem battery 0: Battery not present 1: Battery must be replaced 2: Battery charging 3: Battery needs charging, but temperature too high 4: Battery needs charging, but temperature too low 5: Battery low 6: Battery OK 255: Battery state not available	-	•	-
00034	ProductSoftwareVersionHI	Product software version (BCD diget 1-4 aa.bb)	•	•	•
00035	ProductSoftwareVersionLO	Product software version (BCD diget 5-8 cc.dd)	•	•	•
00036	ProductSoftwareDayMonth	Product software date (BCD ddmm)	•	•	•
00037	ProductSoftwareYear	Product software date (BCD yyyy)	•	•	•

9.4 GSM real time clock

Address	Register name	Description	CIM 200	CIM 250	CIM 500
00080	SetUnixRealTimeClockHI	Set real time clock (32 bit UNIX format)	-	•	-
00081	SetUnixRealTimeClockLO	Triggered on value change	-	•	-
00082	SetRtcSecond	Set real time clock (seconds)	-	•	-
00083	SetRtcMinute	Set real time clock (minutes)	-	•	-
00084	SetRtcHour	Set real time clock (hours)	-	•	-
00085	SetRtcDay	Set real time clock (day)	-	•	-
00086	SetRtcMonth	Set real time clock (month)	-	•	-
00087	SetRtcYear	Set real time clock (year)	-	•	-
00088	Bit 0: SetRtc	Triggers setting of real time clock (s/m/h/d/m/y format)	-	•	-
00089	StatusUnixRealTimeClockHI	Real time clock (32 bit UNIX format)	-	•	-
00090	StatusUnixRealTimeClockLO				
00091	StatusRtcSecond	Real time clock - seconds	-	•	-
00092	StatusRtcMinute	Real time clock - minutes	-	•	-
00093	StatusRtcHour	Real time clock - hours	-	•	-
00094	StatusRtcDay	Real time clock - day of month	-	•	-
00095	StatusRtcMonth	Real time clock - month	-	•	-
00096	StatusRtcYear	Real time clock - year (after 2000)	-	•	-
00097	Bit 0: StatusSetRtcAck	Acknowledge of set RTC command	-	•	-

9.5 Pump control register block

Registers in this block can be read by means of function codes 0x03 and/or 0x04. They can be written as holding registers with function codes 0x06 and 0x10.

Address	Register name	Description
	Bit 0: RemoteAccessReq	Control bit that sets local or remote control. 0: Local 1: Remote (controlled by Modbus master). Set this bit to 1 if a Modbus master should control the E-pump. You can read the actual status from register 00201 bit 8.
	Bit 1: OnOffReq	Control bit that switches the E-pump on or off. 0: Off (stop) 1: On (start). You can read the actual status from register 00201 bit 9.
	Bit 2: ResetAlarm	Control bit that resets alarms and warnings from the E-pump. 0: No resetting 1: Resetting alarm. This control bit is triggered on rising edge only, i.e. setting logical 0 to 1. See section 9.2 CIM configuration register block , address 00005, for acknowledgement behaviour.
00101	Bit 4: CopyToLocal	Control bit that enables copying of remote settings to local pump settings. Only available on MAGNA3 and MGE model H and later. 0: Disabled 1: Enabled. You can read the actual status from register 00201 bit 1. Note: Copy of the Control Context, which is Control mode, Operating mode, On/off and Setpoint, from the remote setting to the local setting takes place when CopyToLocal has been enabled, but only during a Remote->Local transition. It is necessary to introduce such a transition whenever the user wants the local setting to be updated and stored in the EEPROM.
	Bit 5: EnableMaxFlowLimit	Control bit that enables or disables the $FLOW_{LIMIT}$ function. Set the maximum flow limit value in register 00106. Only available on MAGNA3 and MGE model H and later. 0: Disabled (only used in control mode $FLOW_{ADAPT}$) 1: Enabled (used in all control modes). You can read the actual status from register 00201 bit 2.
	Bits 6-15: RESERVED	-
00102	ControlMode	Sets the control mode enumeration. Some modes are not supported by all E-pumps. 0: Constant speed 1: Constant frequency 3: Constant head 4: Constant pressure 5: Constant differential pressure 6: Proportional pressure 7: Constant flow 8: Constant temperature 10: Constant level 128: $AUTO_{ADAPT}$ 129: $FLOW_{ADAPT}$ (set $FLOW_{LIMIT}$ in register 00106) 130: Closed-loop sensor. See section 10.1 Control mode . You can read the actual control mode from register 00203.
00103	OperationMode	A state enumeration to control the E-pump operating mode. 0: Auto-control (setpoint control according to selected control mode) 4: OpenLoopMin (running at minimum speed) 6: OpenLoopMax (running at maximum speed). Note: "OnOffReq" has higher priority than "OperationMode", meaning that you must set "OnOffReq" to "On" for "OperationMode" to have any effect. You can read the actual operation mode from register 00204.
00104	Setpoint	Sets the E-pump setpoint. The scale is 0.01 %, so the value must be from 0 to 10000 to represent the entire 0-100 % range. Closed loop Percentage of setpoint range. Open loop Percentage of nominal frequency. Common examples 4700: 47 % 8000: 80 %. See section 10.2 Setpoint in closed-loop control . You can read the actual setpoint from register 00338 UserSetpoint

Address	Register name	Description
	RelayControl	A register to control the relays. It is bitwise interpreted as follows:
	Bit 0: Relay1Control	Controls the state of relay 1. 0: Closed 1: Open Only E-pumps and CUE.
	Bit 1: Relay2Control	Controls the state of relay 2. 0: Closed 1: Open Only CUE, large MGE, MGE model H and later.
00105	Bits 2: Relay3Control	Controls the state of relay 3. 0: Closed 1: Open Only CUE, large MGE, MGE model H and later.
	Bits 3: Relay4Control	Controls the state of relay 4. 0: Closed 1: Open Only CUE, large MGE, MGE model H and later.
	Bits 4-15: RESERVED	-
00106	SetMaxFlowLimit	Sets the maximum flow limit, $FLOW_{LIMIT}$. It must be enabled in register 00101, bit 5. The value is set in $0.01 \text{ m}^3/\text{h}$. If enabled, the $FLOW_{LIMIT}$ is active in all control modes. If disabled, the maximum flow limit will only be active in $FLOW_{ADAPT}$ control mode. Read actual value in register 00345 Only available on MAGNA3 and MGE model H and later.
00107	SetPumpUnixRtcHI	Sets the real-time clock in the pump in unix format (seconds since 01-01-1970).
00108	SetPumpUnixRtcLO	Only available on MAGNA3 and MGE model H and later.

9.6 Pump status register block

Registers in this register block can be read by means of function codes 0x03 and/or 0x04. They are read-only.

Address	Register name	Description
00201	Bits 0: LowFlowStop	Indicates if the state of "Low Flow Stop" function is active or not active. 0: Pump is not in "Low Flow Stop" state 1: Pump is in "Low Flow Stop" state Only available on MAGNA3 and MGE model H and later.
	Bit 1: CopyToLocal	Indicates if the remote settings of setpoint, operating mode, control mode and on/off state will be automatically copied to local settings. 0: Copying disabled 1: Copying enabled. Only available on MAGNA3 and MGE model H and later.
	Bit 2: MaxFlowLimitEnabled	Indicates if the MaxFlowLimit is enabled. Enable it with register 00101, bit 5. Only available on MAGNA3 and MGE model H and later. 0: Disabled 1: Enabled.
	Bit 3: ResetAlarmAck	Indicates if a ResetAlarm command was acknowledged by the device. This bit will be set when the CIU has accepted a ResetAlarm command, and the programmer can clear the ResetAlarm bit. The ResetAlarmAck bit will automatically be cleared to 0 by the CIU when the ResetAlarm bit is cleared by the master device, and a new ResetAlarm command can be attempted by raising ResetAlarm bit again. 0: No acknowledgement 1: Command acknowledged. This functionality is only used when AutoAcknowledgeEvents is disabled. See section 9.2 CIM configuration register block .
	Bit 4: SetpointInfluence	Indicates if setpoint influence is active. 0: Not active 1: Active. Only available on MAGNA3 and MGE model H and later.
	Bit 5: AtMaxPower	Indicates if the E-pump is running at its power limit. Only available on MAGNA3 and MGE model H and later. 0: Not running at power limit 1: Running at power limit.
	Bit 6: Rotation	Indicates if the E-pump is rotating, that is running, or not. 0: No rotation 1: Rotation.
	Bit 7: Direction	Indicates the current rotational direction of the E-pump as seen from the ventilator side. 0: Clockwise. 1: Counterclockwise.
	Bit 8: AccessMode	Indicates if the E-pump is locally or remotely controlled. 0: Local (a local control source with higher priority controls the E-pump) 1: Remote (controlled by Modbus master).
	Bit 9: OnOff	Indicates if the E-pump is on or off. 0: Off (stopped, the green LED on the E-pump flashes) 1: On (started, the green LED on the E-pump is on). Started does not necessarily indicate rotation, for instance in case of low-flow stop.
	Bit 10: Fault	Indicates if there is a fault or not. 0: No fault 1: Fault (red LED on the E-pump is on).
	Bit 11: Warning	Indicates if there is a warning or not. The E-pump will continue running even if there is a warning. 0: No warning 1: Warning (red LED on the E-pump is on).
	Bit 12: ForcedToLocal	State of the "Forced to local" control option 0: Not forced to local 1: Forced to local. Only available on MAGNA3 and MGE model H and later.
	Bit 13: AtMaxSpeed	Indicates if the E-pump is running at maximum speed. 0: No 1: Yes.
	Bit 14: RESERVED	-
Bit 15: AtMinSpeed	Indicates if the E-pump is running at minimum speed. 0: No 1: Yes.	

Address	Register name	Description
00202	ProcessFeedback	Indicates the actual process feedback from the E-pump. The scale is 0.01 %, so the valid value range is from 0 to 10000. This value can be compared with the setpoint value. Closed loop Percentage of closed-loop feedback sensor range. Open loop Percentage of E-pump performance. Common examples 4700: 47 % 8000: 80 %.
00203	ControlMode	Indicates the actual control mode. 0: Constant speed 1: Constant frequency 3: Constant head 4: Constant pressure 5: Constant differential pressure 6: Proportional pressure 7: Constant flow 8: Constant temperature 10: Constant level 128: AUTO _{ADAPT} 129: FLOW _{ADAPT} 130: Closed-loop sensor.
00204	OperationMode	Indicates the actual operating mode. 0: Auto-control (setpoint control according to selected control mode) 4: OpenLoopMin (running at minimum speed) 6: OpenLoopMax (running at maximum speed).
00205	AlarmCode	The Grundfos-specific alarm code. See section 16. Grundfos alarm and warning codes .
00206	WarningCode	The Grundfos-specific warning code. See section 16. Grundfos alarm and warning codes .
00207	Bits 0-7: MonthsToBearingService	Indicates the number of months until the next bearing service (not available on all E-pumps). This value can be 0, 1, 3, 6, 12 and 24 months, if available. A value of 24 months means "24 months or more". A value of 0xFF indicates that the information is not available.
	Bit 8: BearingServiceType	Indicates the type of the next bearing service (not available on all E-pumps). 0: Lubricate bearings 1: Change bearings.
	Bits 9-15: RESERVED	-
00208	DriveState	Dynamic drive state variable: 0: Stopped 1: Accelerating 2: Decelerating 3: Steady state/closed loop 4: - 5: Accelerating halt 6: Decelerating halt 7: Start on the run (flying cut-in) Only MGE motors and CUE drives.
00209	FeedbackSensorUnit	Indicates the unit of the feedback sensor. 0: bar 1: mbar 2: m 3: kPa 4: psi 5: ft 6: m ³ /h 7: m ³ /s 8: l/s 9: gpm 10: °C 11: °F 12: % 13: K 14: W.
00210	FeedbackSensorMin	Minimum value of the feedback sensor. Unit of the sensor minimum is defined by register 00209.
00211	FeedbackSensorMax	Maximum value of the feedback sensor. Unit of the sensor maximum is defined by register 00209.
00212	NomFrequency	Nominal pump frequency. Scale 0.1 Hz.
00213	MinFrequency	Minimum pump frequency in % of nominal frequency. Scale 0.01 %.
00214	MaxFrequency	Maximum pump frequency in % of nominal frequency. Scale 0.01 %.

Address	Register name	Description
00215	SetpointRangeMin	Minimum value of setpoint range in % of sensor maximum value. Scale 0.01 %.
00216	SetpointRangeMax	Maximum value of setpoint range in % of sensor maximum value. Scale 0.01 %.
00217	RESERVED	
00218	RESERVED	
00219	RESERVED	
00220	RESERVED	
00221	FlowEstimationState	State of the flow estimation algorithm 0: Flow estimation within range 1: Flow estimation below range 2: Flow estimation above range

9.7 Pump data register block

Registers in this block can be read by means of function codes 0x03 and/or 0x04. They are read-only. The table below shows which registers each E-pump type supports.



Unless otherwise stated, the data type used for counters and scaled values is always an unsigned integer.

Table legend

- 3-ph: 3-phase only.
- CUE: CUE drive only.
- MGE: Pumps with MGE motor only.
- G: Only available on model G and later versions.
- H: Only available on model H and later versions.
- S: Sensor required.
- : Always available.
- *: If the E-pump is a TPE Series 2000, the value is estimated and always available.

Address	Register name	Description	Scale	0.25 - 7.5 kW	11-22 kW + CUE	MAGNA3
00301	Head	Actual system head/pressure.	0.001 bar	S	S	•
00302	VolumeFlow	Actual system flow.	0.1 m ³ /h	S*	S*	•
00303	RelativePerformance	Performance relative to maximum performance.	0.01 %	•	•	•
00304	Speed	Motor speed.	1 rpm	•	•	•
00305	Frequency	Actual control signal applied to motor.	0.1 Hz	•	•	•
00306	DigitalInput	Logical value of external digital input signals.	bits	•	•	•
00307	DigitalOutput	Logical value of external digital output signals.	bits	•	•	•
00308	ActualSetpoint	Actual setpoint: Open loop: % of nominal frequency. Closed loop: % of sensor maximum.	0.01 %	•	•	•
00309	MotorCurrent	Actual motor current.	0.1 A	•	•	•
00310	DCLinkVoltage	Frequency converter DC-Link voltage.	0.1 V	•	•	•
00311	MotorVoltage	Motor voltage.	0.1 V	Model G only	•	-
00312	PowerHI	Total power consumption of the system.	1 W	•	•	•
00313	PowerLO					
00314	RemoteFlow	Measured flow at external sensor.	0.1 m ³ /h	G + S	S	-
00315	InletPressure	System inlet pressure, relative to atmospheric pressure. It has an offset of -1.000 bar.	0.001 bar	G + S	S	-
00316	RemotePressure	Measured pressure at external sensor, relative to atmospheric pressure.	0.001 bar	G + S	S	S
00317	Level	Tank level. It has an offset of -100 m.	0.01 m	S	S	-
00318	PowerElectronicTemp	Temperature in frequency converter.	0.01 K	•	•	-
00319	MotorTemp	Motor winding temperature.	0.01 K	G + S + 3ph	S	-
00320	RemoteTemp	Temperature at external sensor.	0.01 K	S	S	-
00321	ElectronicTemp	E-pump electronics temperature.	0.01 K	H	MGE	•
00322	PumpLiquidTemp	Pumped-liquid temperature.	0.01 K	G + S	S	•
00323	BearingTempDE	Bearing temperature, drive end.	0.01 K	-	CUE + S	-
00324	BearingTempNDE	Bearing temperature, non-drive end.	0.01 K	-	CUE + S	-
00325	AuxSensorInput	Auxiliary sensor input.	0.01 %	S	S	-
00326	SpecificEnergyConsumption	Specific energy consumption.	1 Wh/m ³	H + S	CUE + S	•
00327	OperationTimeHI	Total operating time of the system.	1 hour	•	•	•
00328	OperationTimeLO					
00329	TotalPoweredTimeHI	Total power-on time of the system.	1 hour	•	•	•
00330	TotalPoweredTimeLO					
00331	Torque	Motor torque.	0.1 Nm	-	•	-
00332	EnergyHI	Total energy consumption of the system.	1 kWh	•	•	•
00333	EnergyLO					
00334	NumberOfStartsHI	Number of times the E-pump has been started.	1 start	•	•	•
00335	NumberOfStartsLO					
00336	RESERVED					

Address	Register name	Description	Scale	0.25 - 7.5 kW	11-22 kW + CUE	MAGNA3
00337	RemoteTemp2	Temperature at external temperature sensor 2.	0.01 K	H + S	-	S
00338	UserSetpoint	User-selected setpoint. Open loop: % of nominal frequency. Closed loop: % of setpoint range.	0.01 %	•	•	•
00339	Diffpressure	Pressure between pump flanges.	0.001 bar	H + S	-	•
00340	OutletPressure	Pressure at pump outlet.	0.001 bar	H + S	-	-
00341	RemotePressure2	Pressure measured by external sensor 2.	0.001 bar	H + S	-	-
00342	LoadPercent	Motor current in percent of rated motor current.	0.01 %	H	-	-
00343	PumpUnixRtcHI	Pump time and date in UNIX format (seconds since 01-01-1970 00:00:00).	1 second	H	-	•
00344	PumpUnixRtcLO					
00345	MaxFlowLimit	Actual maximum flow limit.	0.1 m ³ /h	H	-	•
00346	RemoteDiffTemp	Remote differential temperature.	0.01 K	H + S	-	-
00347	InletDiffPressure	Inlet differential pressure.	0.001 bar	H + S	-	-
00348	OutletDiffPressure	Outlet differential pressure.	0.001 bar	H + S	-	-
00349	RemoteDiffPressure	Remote differential pressure.	0.001 bar	H + S	-	-
00350	StorageTankLevel	Storage tank level.	0.01 m	H + S	-	-
00351	AmbientTemp	Ambient temperature.	0.01 K	H + S	-	-
00352	HeatEnergyCounterHI▶	Total accumulated heat energy in pump lifetime	1 kWh	H + S	-	S
00353	HeatEnergyCounterLO▶					
00354	HeatPowerHI▶	Actual heat power	1 W	H + S	-	S
00355	HeatPowerLO▶					
00356	HeatDiffTemp▶	Differential temperature between forward and return pipe used for heat calculation.	0.01 K	H + S	-	S
00357	VolumeHI	Totally pumped volume	0.01 m ³	H + S	CUE + S	•
00358	VolumeLO					
00359	HeatEnergyCounter2HI▶	Total accumulated heat energy in pump lifetime (direction 2)	1 kWh	-	-	S
00360	HeatEnergyCounter2LO▶					
00361	Volume2HI	Totally pumped volume	0.01 m ³	-	-	•
00362	Volume2LO					

▶: The availability of these measurements requires that the data register 00302 VolumeFlow is available and that a differential temperature measurement is established by one of the below means:

MGE model H and later:

- Direct measurement, where an analog or temperature input has been configured to Remote differential temperature RemoteDiffTemp (register 00346).
- PumpLiquidTemp (register 00322) measured by build-in Grundfos sensor and RemoteTemp2 (register 00337) measured by analog or temperature input.
- RemoteTemp1 (register 00320) and RemoteTemp2 (register 00337) measured by analog or temperature input.

MAGNA3:

For the calculation an estimated flow value and measurement of the liquid temperature by the build-in temperature sensor is used. Connection of an external temperature sensor is needed for the pump to calculate the needed differential temperature.



A data value of 0xFFFF indicates "not available".



Estimated flow can be used for monitoring purposes only. We do not recommend it for controlling purposes.

9.8 Sensor-dependent measurements

As appears from the table, many of the measurement registers require a particular sensor to be present.

Because a limited number of sensors are available, only a few of the "S" marked data modules will be available simultaneously.

The sections following describe the relation between available Modbus measurement registers and the setup of sensors. The description is split into sections for different pump types, because the approach varies.

Old MAGNA and UPE pump types

- No connection of external sensor possible.

MAGNA3

- Connection of temperature sensor and selection of analog input function "Constant temperature control" will make RemoteTemp2 (00337) measurement available.
- Connection of pressure sensor and selection of analog input function "Constant pressure control" will make RemotePressure1 (00316) measurement available.

CUE and all E-pump types except models H and later

Sensor unit configuration with handheld or PC Tool	Modbus data registers generated from sensor measurement		
	Feedback sensor (AI1)	Measuring sensor* (AI2)	Measuring sensor** (AI3)
bar			
mbar			
m	Head (00301)	Head (00301) and	Head (00301) and
kPa	FeedTankLevel (00317) ^{+))}	FeedTankLevel (00317) ^{+))} or	FeedTankLevel (00317) ^{+))} or
psi		InletPressure (00315)	RemotePressure1 (00316)
ft			
m ³ /h			
m ³ /s	VolumeFlow (00302)	VolumeFlow (00302) or	VolumeFlow (00302) or
l/s		RemoteFlow (00314)	RemoteFlow (00314)
gpm			
°C	RemoteTemp1 (00320)	PumpLiquidTemp (00322)	PumpLiquidTemp (00322) or
°F			RemoteTemp1 (00320)
%	AuxSensorInput (00325)	AuxSensorInput (00325)	AuxSensorInput (00325)

* CUE and 11-22 kW E-pumps only.

** CUE, 11-22 kW E-pumps and model G only.

^{+))} Only if "m" or "ft" is selected.

E-pump models H and later

Measured parameters (selected from display or handheld)		Grundfos built-in sensor	Grundfos LiqTec sensor	Mapped to Modbus register
Parameter	Analog input AI1, AI2, AI3	Temperature PT100 input T1, T2		
Pump inlet pressure	•			InletPressure (00315)
Pump inlet diff. pressure	•			InletDiffPressure (00347)
Pump outlet pressure	•			OutletPressure (00340)
Pump outlet diff. pressure	•			OutletDiffPressure (00348)
Pump diff. pressure	•		•	DiffPressure (00339)
Remote pressure 1	•			RemotePressure1 (00316)
Remote pressure 2	•			RemotePressure2 (00341)
Remote diff. pressure	•			RemoteDiffpressure (00349)
Feed tank level	•			FeedTankLevel (00317)
Storage tank level	•			StorageTankLevel (00350)
Pump flow	•			VolumeFlow (00302)
Remote flow	•			RemoteFlow (00314)
Pumped liquid temp	•	•	•	PumpLiquidTemp (00322)
Temperature 1	•	•		RemoteTemp1 (00320)
Temperature 2	•	•		RemoteTemp2 (00337)
Remote diff. temp	•			RemoteDiffTemp (00346)
Ambient temperature	•	•		AmbientTemp (00351)
Motor bearing temp. BE		•		BearingTempDE (00323)
Motor bearing temp. NDE		•		BearingTempNDE (00324)
Other parameter	•			AuxSensorInput (00325)

9.9 Alarm simulation register block (not CUE)

Alarm simulation can be used to simulate alarms and warnings on the E-pump. This is typically used when testing alarm event handling in BMS/SCADA system controllers. Whether the Simulation.AlarmCode register or the Simulation.WarningCode register is used makes no difference. The pump will in both cases react according to the predefined reaction to the code in question.

For the complete list, see chapter [10.4 Alarms and warnings](#).

Not all codes apply to all E-pump types.

Address	Register name	Description	0.25 - 7.5 kW	11-22 kW	MAGNA3
00701	Simulation.AlarmCode	Alarm code to simulate. See section 16. Grundfos alarm and warning codes .	H	•	•
00702	Simulation.WarningCode	Warning code to simulate. See section 16. Grundfos alarm and warning codes .	H	•	•
00708	Simulation.Activate	Used to activate alarm simulation with alarms and warnings selected from registers 00701 and 00702. 0: Deactivate simulation 1: Activate simulation	H	•	•
00709	Simulation.Active	Status on alarm simulation. 0: Alarm simulation not active 1: Alarm simulation active	H	•	•

•: Always available.

H: Only available on model H and later versions.

10. Detailed descriptions of registers

10.1 Control mode

The supported control modes are described further in this section. The control mode is set with register 00102 and its status can be read from register 00203.

Control modes	Description	Illustration
<ul style="list-style-type: none"> > Constant speed (0) > Constant frequency (1) 	<p>Open loop</p> <p>The setpoint of the E-pump is interpreted as the setpoint for the performance.</p> <p>The setpoint value is a percentage of the maximum performance of the E-pump.</p> <p>No sensor is required in these modes.</p>	
<ul style="list-style-type: none"> > Constant head (3) > Constant pressure (4) > Constant differential pressure (5) 	<p>Closed loop</p> <p>The setpoint of the E-pump is interpreted as the setpoint for the pressure.</p> <p>The E-pump adapts the speed so that the pressure is constant, regardless of the flow.</p> <p>A pressure sensor is required.</p>	
<ul style="list-style-type: none"> > Constant flow (7) > Constant temperature (8) > Constant level (10) 	<p>Closed loop</p> <p>The setpoint of the E-pump is interpreted as the setpoint for the flow, temperature or level. Constant flow is indicated in the diagram.</p> <p>A relevant sensor is required:</p> <ul style="list-style-type: none"> • A flow sensor for flow control • a temperature sensor for temperature control • a level sensor for level control. 	
<ul style="list-style-type: none"> > Proportional pressure (6) 	<p>Closed loop</p> <p>The setpoint of the E-pump is interpreted as the setpoint in proportional-pressure mode as shown in the diagram.</p> <p>A pressure sensor is required.</p>	
<ul style="list-style-type: none"> > AUTO_{ADAPT} (128) 	<p>In this control mode, the setpoint curve is a proportional-pressure curve where the setpoint has been set from factory. The AUTO_{ADAPT} algorithm in the pump will, over time, optimise the setpoint value according to the pipe characteristics of the system. The setpoint curve is adjusted in a downward direction.</p>	
<ul style="list-style-type: none"> > FLOW_{ADAPT} (129) 	<p>This control mode works similar to AUTO_{ADAPT}, except that the flow-limiting function, FLOW_{LIMIT}, is always active and limits the flow to the value ActualMaxFlowLimit.</p>	
<ul style="list-style-type: none"> > Closed-loop sensor (130) 	<p>This is a general purpose closed-loop control mode that you can use in cases where the pump is used for a type of control not covered by one of the other control modes.</p>	

H: Pressure (head)

Q: Flow

10.2 Setpoint in closed-loop control

The setpoint is written to register 00104 Setpoint as a percentage value scaled in 0.01 % of the setpoint range. The selected setpoint is reflected in register 00338 UserSetpoint with the same scaling.

The actual setpoint, whether it has been set via Grundfos GO Remote, the pump display, the pump buttons or the fieldbus, can be read from register 00308 ActualSetpoint. It is a percentage value scaled in 0.01 % of register 00211 FeedbackSensorMax.

Generally, the actual setpoint value represents head, pressure, flow, temperature and so on depending on how the feedback sensor has been set to measure. The unit of measure can be read from register 00209 FeedbackSensorUnit.

It is easy to calculate back and forth between the setpoint in percent and its scaled value:

$$X_{act}[\text{unit}] = X_{set}[\%] \times (r_{max} - r_{min}) + r_{min}$$

Where:

- $r_{max} = \text{SetpointRangeMax} \times \text{FeedbackSensorMax} \times \text{FeedbackSensorUnit}$
- $r_{min} = \text{SetpointRangeMin} \times \text{FeedbackSensorMax} \times \text{FeedbackSensorUnit}$

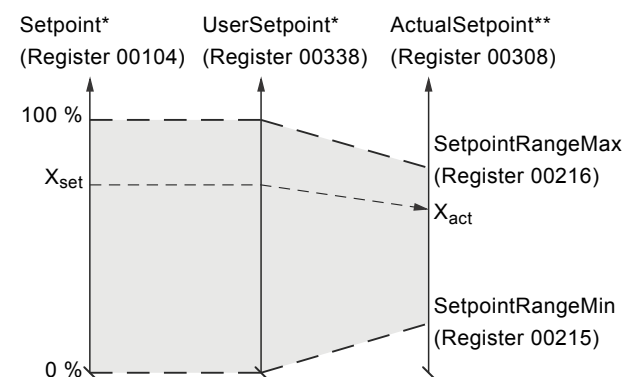

* Percentage of setpoint range.

** Percentage of sensor maximum.

Fig. 21 Setpoint in closed-loop control

MAGNA3 40-100 example

SetpointRangeMin: 5 %

SetpointRangeMax: 50 %

FeedbackSensorMax: 20

FeedbackSensorUnit: m

$$r_{max} = \text{SetpointRangeMax} \times \text{FeedbackSensorMax} \times \text{FeedbackSensorUnit} = 50 \% \times 20 \times \text{m} = 10 \text{ m}$$

$$r_{min} = \text{SetpointRangeMin} \times \text{FeedbackSensorMax} \times \text{FeedbackSensorUnit} = 5 \% \times 20 \times \text{m} = 1 \text{ m}$$

$$X_{act}[\text{unit}] = X_{set}[\%] \times (r_{max} - r_{min}) + r_{min}$$

$$X_{set}[\%] \times (10 \text{ m} - 1 \text{ m}) + 1 \text{ m}$$

$$X_{set}[\%] \times 9 \text{ m} + 1 \text{ m}$$

If $X_{set}[\%]$ has value 40 %, the pump will have an actual setpoint of $40 \% \times 9 \text{ m} + 1 \text{ m} = 4.6 \text{ m}$.

10.3 Setpoint in open-loop control

The setpoint is written to register 00104 Setpoint as a percentage value scaled in 0.01 % of the nominal frequency f_{nom} represented by register 00212 NomFrequency. The selected setpoint is reflected in register 00338 UserSetpoint with the same scaling. From fieldbus, it will get whatever value written to Setpoint. From pump display and Grundfos GO Remote, it is limited to range $[f_{min}; f_{max}]$, represented by 00214 MaxFrequency and 00213 MinFrequency.

The actual setpoint, whether it has been set via Grundfos GO Remote, the pump display, the pump buttons or the fieldbus, can be read from register 00308 ActualSetpoint, and it always reflects the frequency limitations. It equals the value that the pump actually uses.

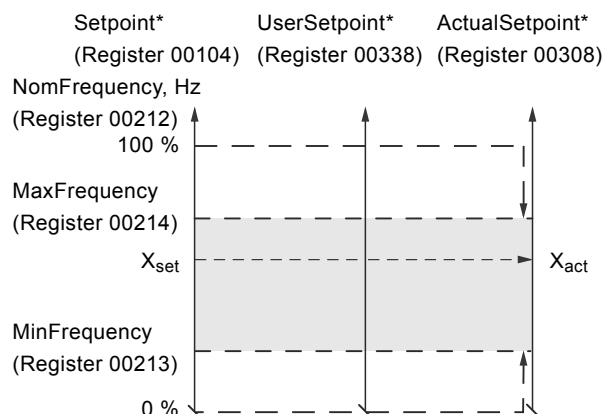

* Percentage of f_{nom} .

Fig. 22 Setpoint in open-loop control

For MGE motors and the CUE drive

- $[f_{min}; f_{max}]$ can be adjusted from the pump display and Grundfos GO Remote.
- With $f_{max} > f_{nom}$ a setpoint above 100 % is possible, over synchronous.

For MAGNA3

- $[f_{min}; f_{max}]$ are fixed.
- f_{max} always equals f_{nom} .

TM07 0154 4317

TM07 0155 4317

10.4 Alarms and warnings

Address	Name	Description
00206	WarningCode	Code for E-pump warning.
00205	FaultCode	Code for E-pump alarm.

In the WarningCode register, the cause of an E-pump warning can be read. A warning has no influence on the E-pump operation.

In the FaultCode register, the cause of an E-pump alarm can be read. An E-pump alarm always leads to a reaction in the E-pump operation, usually the E-pump is stopped, but some alarms in some E-pump types have programmable alarm action types.

The complete list of possible alarm and warning codes is shown below. Not all codes apply to all E-pump types.

Code	Alarm/warning description
1	Leakage current
2	Missing phase
3	External fault signal
4	Too many restarts
7	Too many hardware shutdowns
14	Electronic DC-link protection activated (ERP)
16	Other
29	Turbine operation, impellers forced backwards
30	Change bearings (specific service information)
31	Change varistor(s) (specific service information)
32	Overvoltage
40	Undervoltage
41	Undervoltage transient
42	Cut-in fault (dV/dt)
45	Voltage asymmetry
48	Overload
49	Overcurrent (i_line, i_dc, i_mo)
50	Motor protection function, general shutdown (MPF)
51	Blocked motor or pump
54	Motor protection function, 3 sec. limit
55	Motor current protection activated (MCP)
56	Underload
57	Dry-running
60	Low input power
64	Overtemperature
65	Motor temperature 1 (t_m or t_mo or t_mo1)
66	Control electronics temperature high
67	Temperature too high, internal frequency converter module (t_m)
68	Water temperature high
70	Thermal relay 2 in motor, for example thermistor
72	Hardware fault, type 1
73	Hardware shutdown (HSD)
76	Internal communication fault
77	Communication fault, twin-head pump
80	Hardware fault, type 2
83	Verification error, FE parameter area (EEPROM)
84	Memory access error
85	Verification error, BE parameter area (EEPROM)
88	Sensor fault
89	Signal fault, (feedback) sensor 1
91	Signal fault, temperature 1 sensor
93	Signal fault, sensor 2
96	Setpoint signal outside range
105	Electronic rectifier protection activated (ERP)

Code	Alarm/warning description
106	Electronic inverter protection activated (EIP)
148	Motor bearing temperature high (Pt100) in drive end (DE)
149	Motor bearing temperature high (Pt100) in non-drive end (NDE)
155	Inrush fault
156	Communication fault, internal frequency converter module
157	Real time clock error
161	Sensor supply fault, 5 V
162	Sensor supply fault, 24 V
163	Measurement fault, motor protection
164	Signal fault, Liqtec sensor
165	Signal fault, analog input 1
166	Signal fault, analog input 2
167	Signal fault, analog input 3
175	Signal fault, temperature 2 sensor
176	Signal fault, temperature 3 sensor
190	Limit exceeded, sensor 1
191	Limit exceeded, sensor 2
215	Soft pressure buildup timeout
240	Lubricate bearings (specific service information)
241	Motor phase failure
242	Automatic motor model recognition failed

11. Modbus RTU commissioning, step-by-step guides



If the sensor configuration is changed, restart the CIM module or CIU unit to ensure a correct scaling of the sensor value.

11.1 Hardware setup, CIM 200

Step	Action
1	Install CIM 200 in the Grundfos pump according to the pump documentation.
2	Complete the pump configuration, for example sensor configuration and local mode. This can be done either on the pump control panel, via Grundfos GO Remote or Grundfos PC Tool E-Products.
3	Select the Modbus slave address (1-247).
4	Select the bit rate of the Modbus slave.
5	Select parity and stop bits of the Modbus slave, even parity with 1 stop bit or no parity with 2 stop bits.
6	If necessary, set line termination.
7	Connect the necessary cables from CIM 200 to the Modbus network.
8	Confirm that the GENIbus LED is permanently green and that the Modbus LED is either off, if no master is actively polling the slave, or flashing green, indicating error-free communication.

CIM 200 is now ready to be accessed via the Modbus network.

11.2 Hardware setup, CIU 200

Step	Action
1	Complete the pump configuration, for example sensor configuration and local mode. This can be done either via Grundfos GO Remote or Grundfos PC Tool E-Products.
2	Select the Modbus slave address (1-247).
3	Select the transmission speed of the Modbus slave.
4	Select parity and stop bits of the Modbus slave, even parity with 1 stop bit or no parity with 2 stop bits.
5	If necessary, set line termination.
6	Connect the GENIbus cable from CIU 200 to the E-pump.
7	Connect the necessary cables from CIU 200 to the Modbus network.
8	Connect the power cable to CIU 200, and switch the unit on.
9	Confirm that the GENIbus LED is permanently green and that the Modbus LED is either off, if no master is actively polling the slave, or flashing green, indicating error-free communication.

CIU 200 is now ready to be accessed via the Modbus network.

11.3 Hardware setup, CIM 250 GSM call-up

Step	Action
1	Install CIM 250 in the Grundfos pump according to the pump documentation.
2	Fit a GSM antenna to the CIM module SMA connector. See section 6.1.1 Fitting a GSM antenna .
3	Insert the SIM card in CIM 250. See section 6.1.2 Inserting the SIM card .
4	Power on the Grundfos E-pump.
5	Observe that LED2 turns permanently green, indicating that CIM 250 is fitted correctly. See section 6.2 Status LEDs .
6	Observe that LED1 blinks yellow and changes to yellow pulsing after approximately 30 seconds, indicating that the GSM connection is working. See section 6.2 Status LEDs . By making a call-up from a phone, the connection can be verified. LED1 turns permanently yellow.
7	For configuring CIM 250 for a call-up connection, follow the instructions in the "CIM 25X SMS commands installation and operating instructions" included on CIM/CIU support files CD, section 2.1-3.
8	To verify the GSM settings after completion, you can use the SMS command GSMSETTINGS.

CIM 250 is now ready to be accessed from a Modbus RTU master via GSM call-up, or via SMS commands.

11.4 Hardware setup, CIU 250 GSM call-up

Step	Action
1	Connect the GENIbus cable from CIU 250 to the Grundfos product. See fig. 5 in the "CIU, Communication Interface Unit installation and operating instructions".
2	Fit a GSM antenna to the CIM module SMA connector. See section 6.1.1 Fitting a GSM antenna .
3	Insert the SIM card in CIM 250. See section 6.1.2 Inserting the SIM card .
4	Connect the mains cable to CIU 250, see the CIU quick guide instruction, and power on CIU 250.
5	Power on the Grundfos product
6	Observe that LED2 turns permanently green, indicating that the GENIbus connection is working. See section 6.2 Status LEDs .
7	Observe that LED1 blinks yellow and changes to yellow pulsing after approximately 30 seconds, indicating that the GSM connection is working. See section 6.2 Status LEDs . By making a call-up from a phone, the connection can be verified. LED1 turns permanently yellow.
8	For configuring CIU 250 for a call-up connection, follow the instructions in the "CIM 25X SMS commands installation and operating instructions" included on CIM/CIU support files CD, section 2.1-3.
9	To verify the GSM settings after completion, you can use the SMS command GSMSETTINGS.

CIU 250 is now ready to be accessed from a Modbus RTU master via GSM call-up, or via SMS commands.

11.5 Hardware setup, CIM 250 GPRS connection

Step	Action
1	Install CIM 250 in the Grundfos product according to the product documentation.
2	Fit a GSM antenna to the CIM module SMA connector. See section 6.1.1 Fitting a GSM antenna .
3	Insert the SIM card in CIM 250. See section 6.1.2 Inserting the SIM card .
4	Power on the Grundfos product.
5	Observe that LED2 turns permanently green. See section 6.2 Status LEDs .
6	Observe that LED1 blinks yellow and changes to yellow pulsing after approximately 30 seconds, indicating that the GSM connection is working. See section 6.2 Status LEDs .
7	For configuring CIM 250 for a GPRS connection, follow the instructions in the "CIM 25X SMS commands installation and operating instructions" included on CIM/CIU support files CD, sections 2.1, 2.2 and 2.4.
8	To verify the GPRS setting after completion, you can use the SMS command GPRSSETTING. To verify that the GPRS connection is working, you can use the SMS command GPRSSTATUS. The connection state must be "Context active" if ready and "Connected" if a Modbus TCP master is already communicating.

CIM 250 is now ready to be accessed from a Modbus TCP master via GPRS, or via SMS commands.

11.6 Hardware setup, CIU 250 GPRS connection

Step	Action
1	Connect the GENIbus cable from CIU 250 to the Grundfos product. See the CIU quick guide instruction.
2	Fit a GSM antenna to the CIM module SMA connector. See section 6.1.1 Fitting a GSM antenna .
3	Insert the SIM card in CIM 250. See section 6.1.2 Inserting the SIM card .
4	Connect the mains cable to CIU 250, see the CIU quick-guide instruction, and power on CIU 250.
5	Power on the Grundfos product.
6	Observe that LED2 turns permanently green, indicating that the GENIbus connection is working. See section 6.2 Status LEDs .
7	Observe that LED1 blinks yellow and changes to yellow pulsing after approximately 30 seconds, indicating that the GSM connection is working. See section 6.2 Status LEDs .
8	For configuring CIM 250 for a GPRS connection, follow the instructions in the "CIM 25X SMS commands installation and operating instructions" included on CIM/CIU support files CD, sections 2.1, 2.2 and 2.4.

CIU 250 is now ready to be accessed from a Modbus TCP master via GPRS, or via SMS commands.

11.7 Modbus TCP communication setup, CIM 500

Step	Action
1	Install CIM 500 in the Grundfos E-pump according to the pump documentation.
2	Select position 1 at the protocol rotary switch. See section 7.2 Setting the Industrial Ethernet protocol .
3	Power on the E-pump, and observe LED2 turn permanently green and LED1 remaining off.
4	Complete the pump configuration, for example sensor configuration and selection of local Operating mode, local Control mode and local Setpoint, for example via Grundfos GO Remote.
5	Connect one of the CIM 500 ethernet ports (RJ45) to a PC using an ethernet cable.
6	Configure the PC ethernet port to the same subnetwork as CIM 500, for example 192.168.1.1, and the subnet mask to 255.255.255.0. See section A.1 How to configure an IP address on your PC on page 51.
7	Open your internet browser and make contact to the CIM 500 webserver. Default: 192.168.1.100
8	Log on to the webserver. Default: User: admin Password: Grundfos.
9	In the menu column to the left select: Configuration > Real time Ethernet protocol
10	Type in an IP address belonging to the same subnet as your PC, for example 192.168.1.2.
11	Type in the subnet mask 255.255.255.0, and leave the rest of the settings at their factory default values.
12	Click [Submit] to transfer the new settings, and close the web browser.

CIM 500 is now ready to be accessed from a Modbus TCP master via one of its ethernet ports. Use the IP address selected under step 9. The Modbus address (Unit ID) in the Modbus TCP telegram is not used.

- CIM 500 LED 1 will be flashing green when Modbus TCP communication takes place.
- You can use the two ethernet ports for daisy chaining of CIM 500 modules.
- It is possible to have connection to the webserver simultaneously with a connection to a Modbus TCP master.
- It is possible to have connection to more Modbus TCP masters simultaneously, for example to have connection to PC Tool CIM/CIU while connected to another Modbus TCP master.

11.8 Modbus TCP communication setup, CIU 500

Step	Action
1	Check that both CIU 500 unit and the E-pump are powered off.
2	Remove the front cover of CIU 500.
3	Select position 1 at the CIM 500 module protocol rotary switch. See section 7.2 Setting the Industrial Ethernet protocol .
4	Connect the GENibus cable from CIU 500 to the E-pump. See fig. 5 in "CIU, Communication Interface Unit installation and operating instructions" or see the CIU quick guide.
5	Power on CIU 500 and the E-pump, and observe LED2 turn permanently green and LED1 remaining off.
6	Connect one of the CIU 500 ethernet ports (RJ45) to a PC using an ethernet cable.
7	Configure the PC ethernet port to the same subnetwork as CIM 500, for example 192.168.1.1, and the subnet mask to 255.255.255.0. See section A.1 How to configure an IP address on your PC on page 51.
8	Open your internet browser and make contact to the CIM 500 webserver. Default: 192.168.1.100.
9	Log on to the webserver. Default: User: admin Password: Grundfos.
10	In the menu column to the left select: Configuration > Real time ethernet protocol
11	Type in an IP address belonging to the same subnet as your PC, for example 192.168.1.2.
12	Type in the subnet mask 255.255.255.0, and leave the rest of the settings at their factory default values.
13	Click [Submit] to transfer the new settings and close the web browser.

CIM 500 is now ready to be accessed from a Modbus TCP master via one of its ethernet ports. Use the IP address selected under step 10. The Modbus address (Unit ID) in the Modbus TCP telegram is not used.

- CIU 500 LED 1 will be flashing green when Modbus TCP communication takes place.
- You can use the two ethernet ports for daisy chaining of CIM 500 modules.
- It is possible to have connection to the webserver simultaneously with a connection to a Modbus TCP master.
- It is possible to have connection to more Modbus TCP masters simultaneously, for example to have connection to PC Tool CIM/CIU while connected to another Modbus TCP master.

12. Detailed descriptions of functionality

12.1 GSM

12.1.1 Call-up functional description

The call-up function is used for SCADA system communication via the GSM network. Connection is established when the SCADA system dials CIU 250. CIU 250 will automatically "pick up the phone" and wait for data traffic in the form of Modbus RTU telegrams.

If legal data traffic has not been initiated within one minute, CIU 250 will hang up the line. This silence timeout is active during the whole communication session. Whenever the SCADA system has completed the Modbus communication, it hangs up the line. This is detected by CIU 250, which also hangs up the line, and the call-up communication session is thereby completed. See fig. 23.

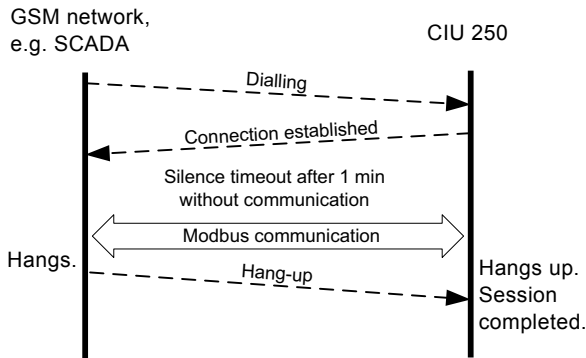

Fig. 23 Illustration of a GSM call-up session

12.1.2 SCADA PIN code protection

It is always possible to get read access via Modbus, but if CIU 250 is SCADA PIN-code-protected (GeneralStatus register 00029, bit 0 = 1), write access requires that the correct PIN code (ScadaPinCode, register 00011) has been written. Writing the correct PIN code will trigger the write access control, and write access will be open, which can be verified with GeneralStatus, register 00029, bit 1 = 1).

For call-up connections with PIN code protection, the ScadaPinCode register has to be written each time a new call-up is made.

12.1.3 GSM call-up options setup

To prepare CIU 250 for Modbus communication with a SCADA system via GSM, some settings have to be made via SMS commands:

- Setting a SCADA PIN code:
SETSCADACODE <access code> will enable write access protection.

Default is an empty SCADA PIN code, meaning no protection.

- Activating the SCADA PIN code:
SCADACODE <ON | OFF>.

Default is "Off".

- Selecting the Modbus address:
MODBUSADDR <1-247>

Default value is 231.

To verify the SCADA GSM setting after completion, you can use the SMS command "SCADA".

For details about the use of SMS commands, see "CIM 25X SMS commands", supplement to the installation and operating instructions, on the CD-ROM supplied with the GSM module.

12.2 GPRS

12.2.1 What is GPRS and Modbus TCP?

GPRS (General Packet Radio Service) is a wireless, "always on" connection that remains active as long as CIU 250 is within range of the service. With GPRS, it is possible to establish a wireless connection to the Internet and thus enable a remote connection to a SCADA system computer or another PC application. Typical data rates are 32 to 48 kbit/s.

The GPRS itself takes care of the wireless data transfer via the GSM network. It plays the same role as ethernet in a wired network. On top of GPRS is the TCP/IP protocol, which enables easy integration with the Internet. The Modbus TCP protocol is used on the application layer communicating with a TCP port number (default 502). The difference when compared to the fieldbus protocol Modbus RTU is the exclusion of the 16-bit CRC checksum and the adding of a Modbus application program header as illustrated in fig. 24.

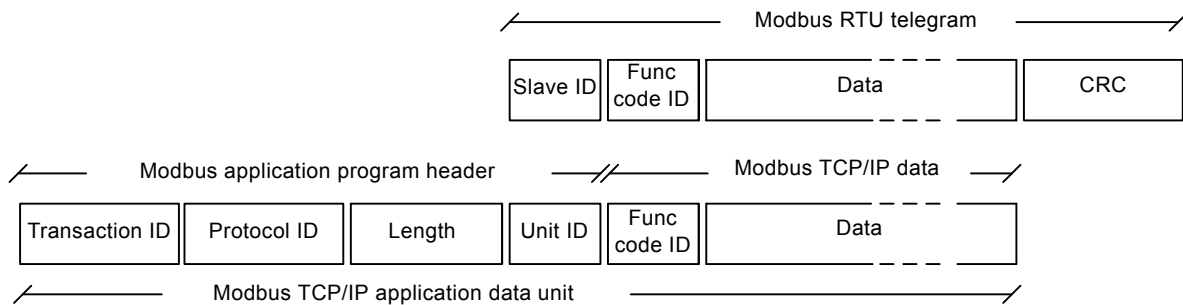

Fig. 24 Modbus TCP telegram

12.2.2 Subscription

The GSM service providers have different technical solutions for GPRS to choose from. You have to select the service provider and the technical solution that best suit your system, and it must be based on static IP addressing. You will get the following from the GSM service provider:

- A Subscriber Identity Module (SIM card).
- An Access Point Name (APN), for example "Internet".
- The user name is fixed and cannot be changed by the user.
- The password is fixed and cannot be changed by the user.
- A static IP address.

Solutions based on a VPN (Virtual Private Network) involve the use of special routers, for example GRE (Generic Routing Encapsulation) routers, which you will also get from the service provider.

12.2.3 Installation

To prepare CIU 250 for GPRS communication, some settings have to be made via SMS commands:

- Select Access Point Name:
APN <ASCII string>
This is always mandatory.
- Select Username:
USERNAME <ASCII string>
The need for a user name depends on your operator and the type of subscription.
- Select Password:
PASSWORD <ASCII string>
The need for a password depends on your operator and the type of subscription.

Some advanced GPRS settings have default values that usually work, but in special cases, it might be necessary to change some of them. This is also done via SMS commands.

- Select Authentication:
AUTHENTICATION <NORMAL | SECURE>
Only used by some service providers. Default value is "Normal".
- Select Connection type:
CONNECTION <SERVER | CLIENT | DISABLE>
Default value is "Server".
- Set GPRS roaming:
GPRSROAMING: <ON | OFF>
Default value is "Off".
- Select Modbus TCP port number:
MODBUSPORT <port no.>
Default value is 502.
- Select GENIpro port number:
GENIPROPORT <port no.>
Default value is 49152. This is only relevant when using Grundfos PC Tools.

It is possible to configure the GPRS connection with a single multi-parameter command:

- SETGPRS <parameter 1, parameter 2, parameter 3, ...>
– <parameters>:<APN>,<Modbus port>,<GENIproport>,<username>,<password>,<authentication>,<connection>,<GPRS roaming>

Example

SETGPRS

Grundfos.dk2.tdc,502,49888,Grundfos,4321,normal.server,off

To verify the GPRS setting after completion, you can use the SMS command GPRSSETTING. The command GPRSSTATUS can verify if the GPRS connection is working.

The connection states have the following meaning:

- "Detached": Trying to locate GPRS service.
- "Attached": GPRS service located.
- "Context active": IP address has been assigned, ready for a client to establish a socket connection.
- "Connected": A client has established a socket connection. The system is ready for TCP/IP data exchange, or already exchanging data.

For details about the use of SMS commands, see "CIM 25X SMS commands", supplement to the installation and operating instructions, on the CD-ROM supplied with the GSM module.

12.2.4 Operation

When powering on CIU 250 with the correct GPRS setting, the following GPRS connection sequence will take place:

1. CIU 250 locates the GPRS service. The connection state changes from "Detached" to "Attached".
2. CIU 250 attempts to connect to the APN it has been given and requests an IP address. The base station looks through its record of legal SIM cards and finds the IP address, the address associated with this SIM card, to assign to CIU 250. After CIU 250 has got the IP address, the connection state changes to "Context active".
3. CIU 250 is now ready for a client, for example SCADA system to establish a socket connection and begin TCP/IP data exchange. When a client connects CIU 250, the connection state will change to "Connected", and the GSM status LED1 will indicate when data transfer takes place. See section [5.5 Status LEDs](#).



When no GPRS data is being transferred, the connection states "Attached", "Context active" and "Connected". All show the same LED1 status (short pulse).

A client, for example SCADA, establishes connection to CIU 250 by specifying the IP address and the TCP port 502. Data transfer is always initiated from the client in the form of a Modbus TCP telegram embedded in a TCP/IP frame and directed to TCP port 502. To the client software, the connection to CIU 250 is completely transparent.

The protection against unauthorised data access is high. The access to the GPRS network from the Internet can only take place via the VPN tunnel. See fig. 26. Moreover, data transfer requires a Modbus master client, knowledge of the Modbus functional profile and the use of a SCADA PIN code, if enabled. CIU 250 supervises the GPRS system to ensure that it is still working. An automatic procedure ensures restarting of CIU 250 and repetition of the GPRS connection sequence in case a deadlock situation has occurred. It also closes down socket connections that are left open by the client and unused for more than 24 hours.

It is possible to use SMS communication while GPRS communication is active. However, in the "Connected" state the delay time between reception and reply increases. If the connection state is different from "Connected", it is possible to establish a call-up connection. When the call-up connection is established, GPRS data exchange will be blocked until the call-up is terminated by the caller.

A total of three Modbus clients can be connected to the Modbus TCP port of CIU 250 and communicate simultaneously. Each connection, called a socket connection, is handled independently. If all three sockets are used simultaneously, a "Silence time-out" of only one minute is used to prevent a complete occupation for a long time.

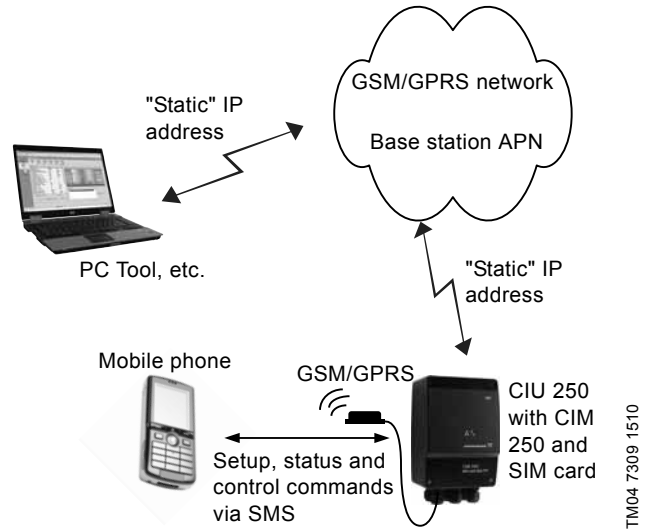

Fig. 25 GPRS connection from a PC to CIU 250 directly via GPRS

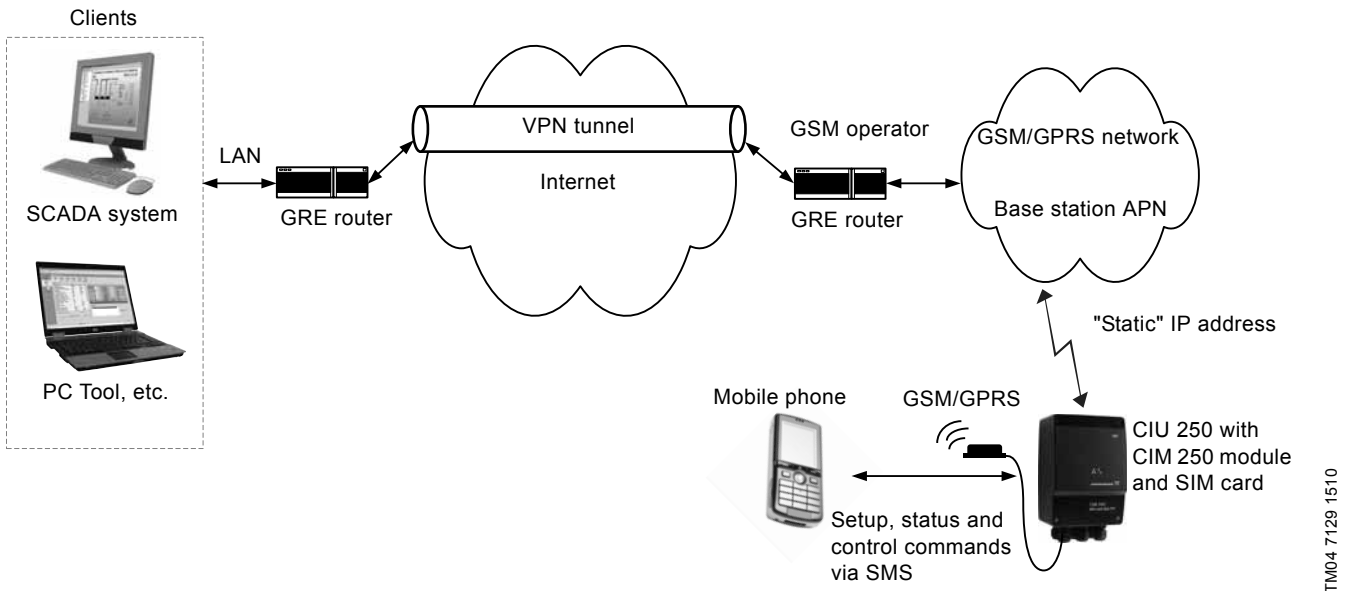

Fig. 26 GPRS connection via VPN tunnel

13. Modbus RTU telegram examples



The Modbus data model states that registers numbered X are addressed in telegrams as X - 1, for example register 00104 (setpoint) is addressed as 00103 in a Modbus telegram.

Note that CRC fields are not shown in the following examples.

13.1 Modbus telegram overview

The maximum size of a Modbus RTU telegram is 256 bytes. Telegrams must be separated by a silent interval of at least 3.5 character times.

The standard Modbus RTU telegram format is shown in the table below.

Slave address	Function code	Data	CRC
1 byte	1 byte	0 to 252 bytes	2 bytes

A telegram starts with the slave address occupying one byte. Then comes a variable-size data field. For each telegram, a CRC is calculated and appended to the telegram, two bytes total. All bytes in the telegram, except for the CRC itself, are included in the check.

Note that the CRC bytes are not shown in the examples in the following sections.

13.2 Read holding registers, 0x03

This function is used for reading holding registers from the slave. The request telegram specifies the starting address, that is the address of the first register to be read, and the number of holding registers to read. In the telegram, register addresses start from zero, meaning that registers numbered 0-16 are addressed as 0-15.

Example of request from master to slave

Field	Value
Address	0x01
Function code	0x03
Start address HI	0x00
Start address LO	0x6B
Quantity HI	0x00
Quantity LO	0x03

In the request, the slave with address 1 is asked to deliver three contiguous registers starting from address 0x006b = 107, meaning register 108.

Example of response from slave to master

Field	Value
Address	0x01
Function code	0x03
Byte count	0x06
Register 108 HI	0x00
Register 108 LO	0x01
Register 109 HI	0x00
Register 109 LO	0x01
Register 110 HI	0x00
Register 110 LO	0x01

In the response, the byte count is six since there are three registers of two bytes. All three registers hold the value of 0x0001.

13.3 Read input registers, 0x04

This function is used for reading input registers from the slave. Input registers are read-only registers by definition. The request telegram specifies the starting address, that is the address of the first register to be read, and the number of holding registers to read. In the telegram, register addresses start from zero, meaning that registers numbered 0-16 are addressed as 0-15.

Example of request from master to slave

Field	Value
Address	0x01
Function code	0x04
Start address HI	0x10
Start address LO	0x10
Quantity HI	0x00
Quantity LO	0x03

In the request, the slave with address 1 is asked to deliver three contiguous registers starting from address 0x1010 = 4112, meaning register 4113.

Example of response from slave to master

Field	Value
Address	0x01
Function code	0x04
Byte count	0x06
Register 4113 HI	0x22
Register 4113 LO	0x22
Register 4114 HI	0x22
Register 4114 LO	0x22
Register 4115 HI	0x22
Register 4115 LO	0x22

In the response, the byte count is six since there are three registers of two bytes. All three registers hold the value of 0x2222.

13.4 Write single register, 0x06

This function is used for writing a single holding register in the slave. The request telegram specifies the address of the register that is to be written. Register addresses start from zero, meaning that a register numbered 10 is addressed as 9.

The normal response is an echo of the request, indicating that the value was written.

Example of request from master to slave

Field	Value
Address	0x01
Function code	0x06
Address HI	0x10
Address LO	0x00
Value HI	0xAF
Value LO	0xFE

In the request, the slave with address 1 is asked to write the value of 0xAFFE to the register at address 0x1000.

Example of response from slave to master

Field	Value
Address	0x01
Function code	0x06
Address HI	0x10
Address LO	0x00
Value HI	0xAF
Value LO	0xFE

The response is an echo of the request.

13.5 Write multiple registers, 0x10

This function is used for writing a block of contiguous holding registers in the slave. Register addresses start from zero, meaning that a register numbered 100 is addressed as 99.

Example of request from master to slave

Field	Value
Address	0x01
Function code	0x10
Start address HI	0x00
Start address LO	0x20
Quantity HI	0x00
Quantity LO	0x02
Byte count	0x04
Register 33 HI	0x00
Register 33 LO	0x01
Register 34 HI	0xB0
Register 34 LO	0xB0

In the request, the slave with address 1 is asked to write the value of 0x0001 to the register at address 0x0020 and the value of 0xB0B0 to the register at address 0x0021.

Example of response from slave to master

Field	Value
Address	0x01
Function code	0x10
Start address HI	0x00
Start address LO	0x20
Quantity written HI	0x00
Quantity written LO	0x02

The response returns the function code, starting address and quantity of registers written.

13.6 Diagnostics, 0x08

This function provides a test for checking the communication system between the master and the Grundfos slave. It contains a single-byte subcode to identify the test to be performed.

The following subcodes are supported:

Subcode	Name
0x00	Return query data Data in this request are to be echoed in the response. The response must be identical to the request, so this function is often used to verify Modbus communication.
0x01	Restart communications All communication counters are cleared, and the device is restarted.
0x02	Return diagnostics register Returns the 16-bit diagnostics register. See section 13.7 Diagnostics register interpretation .
0x04	Force listen only Forces the device into listen-only mode. This effectively mutes the device, making it unable to communicate on the network. To bring the device back to normal mode, a "Restart communications" command, code 0x08, subcode 0x01, must be issued.
0x0A	Clear counters and diagnostics register Clears all counters and the diagnostics register. These are also cleared on power-up and restart.
0x0B	Return bus message count Returns the number of messages detected by the slave.
0x0C	Return bus CRC error count Returns the number of CRC errors in the slave.
0x0D	Return bus exception count Returns the number of Modbus exception responses that the slave has transmitted.
0x0E	Return slave message count Returns the number of messages that the slave has processed.
0x0F	Return slave no response count Returns the number of messages for which the slave has sent no response.
0x12	Return bus character overrun count Returns the number of overruns in the slave.
0x14	Clear overrun counter Clears the overrun counter. This is also cleared on power-up and restart.

Example of request from master to slave

Field	Value
Address	0x01
Function code	0x08
Subcode	0x00
Data	0xAB
Data	0xCD

The response is identical to the request.

Example of response from slave to master

Field	Value
Address	0x01
Function code	0x08
Subcode	0x00
Data	0xAB
Data	0xCD

13.7 Diagnostics register interpretation

The diagnostics register is interpreted as follows:

Bit	Description
0	Communication failure, with the Grundfos E-pump.
1	EEPROM self-test has failed. The test is carried out when system is booted.
2	Grundfos E-pump is not supported.
3	Modbus address offset is different from default value, i.e. it differs from 0.
4	Using software-defined Modbus transmission speed.
5	RESERVED
6	RESERVED
7	RESERVED
8	RESERVED
9	RESERVED
10	RESERVED
11	RESERVED
12	RESERVED
13	RESERVED
14	RESERVED
15	RESERVED

A bit value of 1 means true, unless otherwise specified. The diagnostics register is read using function code 0x08 and subcode 0x02.

13.8 Diagnostics: Return query data

This function is useful to ensure that the communication path and slave configuration are correct. It will echo the request in the response.

In the example, slave address 0x01 is used.

Request from master to slave

Field	Value	Description
Slave address	0x01	-
Function code	0x08	Diagnostics
Subcode	0x00	Echo request
Data	0xAB	Test data
Data	0xCD	Test data

Example of response from slave to master

Field	Value	Description
Slave address	0x01	-
Function code	0x08	Diagnostics
Subcode	0x00	Echo request
Data	0xAB	Test data
Data	0xCD	Test data

If there is no response from the slave, see section [14.1.2 CIM/CIU 200 Modbus communication faults](#) or [14.2.2 CIM/CIU 250 Modbus GSM/GPRS communication faults](#).

13.9 Reading the CIM configuration register block

This section shows how to read the first four registers of the CIM configuration register block.

In the example, slave address 0x01 is used.

Request from master to slave

Field	Value	Description
Slave address	0x01	-
Function code	0x04	Read input registers
Start address HI	0x00	Start address = 0x0001
Start address LO	0x00	
Quantity HI	0x00	Number of registers = 0x0004
Quantity LO	0x04	

Example of response from slave to master

Field	Value	Description
Slave address	0x01	-
Function code	0x04	Read input registers
Byte count	0x08	8 bytes follow
00001 HI	0x00	SlaveMinimumReplyDelay = 0x000A
00001 LO	0x0A	
00002 HI	0x00	RegisterOffset = 0x0000
00002 LO	0x00	
00003 HI	0x00	Reserved value = 0x0000
00003 LO	0x00	
00004 HI	0x00	SoftwareDefinedBitRate = 0x0004
00004 LO	0x04	

If there is no response from the slave, see Fault finding, section [14.1.2 CIM/CIU 200 Modbus communication faults](#) or [14.2.2 CIM/CIU 250 Modbus GSM/GPRS communication faults](#).

13.10 Setting the setpoint

This section shows how to set a new setpoint (reference).

In the example, slave address 0x01 is used, and a value of 55 % (5500 = 0x157C) is set as new setpoint.

Request from master to slave

Field	Value	Description
Slave address	0x01	-
Function code	0x06	Write single register
Start address HI	0x00	Setpoint address = 00104 (0x0068)
Start address LO	0x67	
Value HI	0x15	New setpoint value = 5500 (0x157C)
Value LO	0x7C	

Example of response from slave to master

Field	Value	Description
Slave address	0x01	-
Function code	0x06	Write single register
Start address HI	0x00	Setpoint address = 00104 (0x0068)
Start address LO	0x67	
Value HI	0x15	New setpoint value = 5500 (0x157C)
Value LO	0x7C	

If there is no response from the slave, see section [14.1.2 CIM/CIU 200 Modbus communication faults](#) or [14.2.2 CIM/CIU 250 Modbus GSM/GPRS communication faults](#).

13.11 Setting the control mode

This section shows how to set a control mode.

In the example, slave address 0x01 is used, and the control mode is set to 1 (Constant frequency).

Request from master to slave

Field	Value	Description
Slave address	0x01	-
Function code	0x06	Write single register
Start address HI	0x00	ControlMode address
Start address LO	0x65	= 00102 (0x0066)
Value HI	0x00	New ControlMode value
Value LO	0x01	= 1 (0x0001)

Example of response from slave to master

Field	Value	Description
Slave address	0x01	-
Function code	0x06	Write single register
Start address HI	0x00	ControlMode address
Start address LO	0x65	= 00102 (0x0066)
Value HI	0x00	New ControlMode value
Value LO	0x01	= 1 (0x0001)

If there is no response from the slave, see Fault finding, section [14.1.2 CIM/CIU 200 Modbus communication faults](#) or [14.2.2 CIM/CIU 250 Modbus GSM/GPRS communication faults](#).

13.12 Starting the E-pump

This section shows how to start the E-pump.

In the example, slave address 0x01 is used.

Set the ControlRegister to the following values:

- Bit 0: 1 (set the E-pump to remote mode)
- Bit 1: 1 (start the E-pump)
- Bit 2: 0 (do not send a reset fault command)
- Bit 3: 0 (direction = clockwise rotation)
- Bit 4: 0 (do not copy remote settings to local)
- Bits 5-15: 0 (reserved values)

Hence the value to set is 0b0000000000000011 = 0x0003.

Request from master to slave

Field	Value	Description
Slave address	0x01	-
Function code	0x06	Write single register
Start address HI	0x00	ControlRegister address
Start address LO	0x64	= 00101 (0x0065)
Value HI	0x00	ControlRegister value
Value LO	0x03	= 3 (0x0003)

Example of response from slave to master

Field	Value	Description
Slave address	0x01	-
Function code	0x06	Write single register
Start address HI	0x00	ControlRegister address
Start address LO	0x64	= 00101 (0x0065)
Value HI	0x00	ControlRegister value
Value LO	0x03	= 3 (0x0003)

If there is no response from the slave, see section [14.1.2 CIM/CIU 200 Modbus communication faults](#) or [14.2.2 CIM/CIU 250 Modbus GSM/GPRS communication faults](#).

13.13 Stopping the E-pump

This section shows how to stop the E-pump.

In the example, slave address 0x01 is used.

Set the ControlRegister to the following values:

- Bit 0: 1 (set the E-pump to remote mode)
 - Bit 1: 0 (stop the E-pump)
 - Bit 2: 0 (do not send a reset fault command)
 - Bit 3: 0 (direction = clockwise rotation)
 - Bit 4: 0 (do not copy remote settings to local)
 - Bits 5-15: 0 (reserved values)
- Hence the value to set is 0b0000000000000001 = 0x0001.

Request from master to slave

Field	Value	Description
Slave address	0x01	-
Function code	0x06	Write single register
Start address HI	0x00	ControlRegister address
Start address LO	0x64	= 00101 (0x0065)
Value HI	0x00	ControlRegister value
Value LO	0x01	= 1 (0x0001)

Example of response from slave to master

Field	Value	Description
Slave address	0x01	-
Function code	0x06	Write single register
Start address HI	0x00	ControlRegister address
Start address LO	0x64	= 00101 (0x0065)
Value HI	0x00	ControlRegister value
Value LO	0x01	= 1 (0x0001)

If there is no response from the slave, see section [14.1.2 CIM/CIU 200 Modbus communication faults](#) or [14.2.2 CIM/CIU 250 Modbus GSM/GPRS communication faults](#).

14. Fault finding the product

14.1 CIM/CIU 200

You can detect faults in CIM/CIU 200 by observing the status of the two communication LEDs. See the table below and section [3.2 Modbus RTU, CIM 200](#).

14.1.1 LED status

CIM 200 fitted in a Grundfos E-pump

Fault (LED status)	Possible cause	Remedy
1. Both LED1 and LED2 remain off when the power supply is connected.	a) CIM 200 is fitted incorrectly in the Grundfos E-pump.	Ensure that CIM 200 is fitted and connected correctly.
	b) CIM 200 is defective.	Replace CIM 200.
2. LED2 for internal communication is flashing red.	a) No internal communication between CIM 200 and the Grundfos E-pump.	Ensure that CIM 200 is fitted correctly in the Grundfos E-pump.
3. LED2 for internal communication is permanently red.	a) CIM 200 does not support the Grundfos E-pump connected.	Contact the nearest Grundfos company.
4. The Modbus LED1 is permanently red.	a) Fault in the CIM 200 Modbus configuration.	<ul style="list-style-type: none"> • Check the transmission speed, switches SW4 and SW5. If the switches are set to "software-defined", an invalid value may have been set via Modbus. Try one of the preselected transmission speeds, for example 19200 bits/s. • Check that the Modbus address, switches SW6 and SW7, has a valid value [1-247].
5. The Modbus LED1 is flashing red.	a) Fault in the Modbus communication (fault in parity or cyclic redundancy check).	<ul style="list-style-type: none"> • Check the transmission speed, switches SW4 and SW5. See section 5.1 Setting the Modbus transmission speed. • Check the parity setting, switch SW3. See section 5.2 Setting the parity. • Check the cable connection between CIM 200 and the Modbus network. • Check the termination resistor settings, switches SW1 and SW2. See section 5.4 Termination resistor.

CIM 200 fitted in CIU 200

Fault (LED status)	Possible cause	Remedy
1. Both LED1 and LED2 remain off when the power supply is connected.	a) CIU 200 is defective.	Replace CIU 200.
2. The LED2 for internal communication is flashing red.	a) No internal communication between CIU 200 and the E-pump	<ul style="list-style-type: none"> • Check the cable connection between the E-pump and CIU 200. • Check that the individual conductors have been fitted correctly. • Check the power supply to the E-pump.
3. The LED2 for internal communication is permanently red.	a) CIU 200 does not support the E-pump which is connected.	Contact the nearest Grundfos company.
4. The Modbus LED1 is permanently red.	a) Fault in the CIM 200 Modbus configuration.	<ul style="list-style-type: none"> • Check the transmission speed, switches SW4 and SW5. If the switches are set to "software-defined", an invalid value may have been set via Modbus. Try one of the preselected transmission speeds, for example 19200 bits/s. • Check that the Modbus address, switches SW6 and SW7 has a valid value [1-247].
5. The Modbus LED1 is flashing red.	a) Fault in the Modbus communication (fault in parity or cyclic redundancy check).	<ul style="list-style-type: none"> • Check the transmission speed, switches SW4 and SW5. See section 5.1 Setting the Modbus transmission speed. • Check the parity setting, switch SW3. See section 5.2 Setting the parity. • Check the cable connection between CIM 200 and the Modbus network. • Check the termination resistor settings, switches SW1 and SW2. See section 5.4 Termination resistor.

14.1.2 CIM/CIU 200 Modbus communication faults

Fault	Possible cause	Remedy
1. The slave does not respond to telegrams.	a) Configuration or wiring error.	<ul style="list-style-type: none"> • Check the visual diagnostics on the Modbus slave. Is the Grundfos GENIbus LED flashing green and the Modbus LED off or flashing green? • Ensure that the cable between the Modbus master and the Modbus slave is connected correctly. See section 5. Modbus RTU, CIM 200 setup for wiring recommendations. • Ensure that the slave address is configured correctly, and that the correct slave address is used in the Modbus master poll. See section 5.3 Modbus address selection for slave address selection. • Ensure that the transmission speed and stop bit/parity settings are configured correctly in both master and slave. • Ensure that each end of the Modbus trunk cable is terminated, if necessary. See section 5.4 Termination resistor for line termination of the Grundfos slave. • Ensure that the bus topology for a Modbus network is correct.
	b) The slave may be in listen-only mode.	Either send a restart communications diagnostics command, or restart the E-pump manually.
	c) If the holding register of address 00001 "SlaveMinimumReplyDelay" is set too high, the master may time out before receiving the response from the slave.	Increase the time-out span in the master in order to communicate.
2. The slave responds with exception response 0x01: "Invalid function".	a) The master is trying to use an unsupported function in the module or unit.	See section 8. Modbus function code overview for supported function codes. Note that reading and writing coils are not supported, so only register functions and diagnostics will be valid.
3. The slave responds with exception response 0x02: "Invalid data address".	a) The master is trying to read or write an invalid data address. If a master tries to read register addresses that are not listed in the tables, the slave will respond with this exception response. Some masters may automatically try to read large blocks in one telegram, which will cause problems if some of the registers in the block are not supported. An example would be reading the CIM configuration and CIM status blocks in one telegram. This is not possible since there are unused addresses between the blocks.	<ul style="list-style-type: none"> • Avoid reading or writing invalid data addresses. • Make sure that register X is addressed as X - 1 in Modbus telegrams, according to the Modbus standard.
	b) The register address offset may have been changed from default.	Read the holding register at address 00002 "Register Offset" to see if this value is different from 0. If so, write the value 0 to this address to make the slave return to the default used in this functional profile.
4. The slave returns data value 0xFFFF (65535).	a) The value is unavailable. A data value of 0xFFFF does not necessarily indicate an error condition. It means that the value is unavailable from the E-pump.	See section 9. Modbus register addresses for available data.
	b) The E-pump is not configured to show the value or lacks a sensor to read the value.	See section 9.7 Pump data register block for data values that require a sensor.
5. The slave does not change Modbus transmission speed with register 0004.	a) Configuration error.	Set the transmission speed switches to "Software-defined". Otherwise, the value in register 0004 is ignored by the slave.
	b) An invalid value may be set in register 00004.	See section 5.1 Setting the Modbus transmission speed for invalid values, and set correct value in register 00004.

14.2 CIM/CIU 250

You can detect faults in CIU 250 by observing the status of the two communication LEDs. See the table below and section [3.3 Modbus GSM/GPRS, CIM 250](#).

14.2.1 LED status

CIU 250 connected to an E-pump

Fault (LED status)	Possible cause	Remedy
1. Both LED1 and LED2 remain off when the power supply is connected.	a) CIU 250 is defective.	Replace CIU 250.
2. The LED2 for internal communication is flashing red.	a) No internal communication between CIU 250 and the E-pump.	<ul style="list-style-type: none"> • Check the cable connection between the E-pump and CIU 250. • Check that the individual conductors have been fitted correctly. • Check the power supply to the E-pump.
3. LED2 for internal communication is permanently red.	a) CIU 250 does not support the connected version of the E-pump.	Contact the nearest Grundfos company.
4. LED1 for GSM/GPRS communication is flashing yellow. See signal 1 in fig. 16 on page 12.	a) The SIM card has not been inserted.	Insert the SIM card. See section 6.1.2 Inserting the SIM card .
	b) The SIM card has not been inserted correctly.	Insert the SIM card. See section 6.1.2 Inserting the SIM card .
	c) The SIM card PIN code is not correct.	Enter the correct PIN code. See section 6.1.2 Inserting the SIM card .
	d) No connection to the GSM network.	<ul style="list-style-type: none"> • Check the connection to the antenna. • Check the GSM coverage of the area using for instance a mobile phone. • Use an external antenna and experiment with the position.
5. The LED1 for GSM/GPRS communication is pulsating yellow with single pulse, but CIM 250 cannot send or receive SMS messages.	a) CIM 250 has not been initialised.	Follow the configuration procedure in "CIM 25X SMS commands", supplement to installation and operating instructions, on the CD-ROM supplied with the GSM module.

CIM 250 fitted in CIU 250

Fault (LED status)	Possible cause	Remedy
1. Both LED1 and LED2 remain off when the power supply is connected.	a) CIM 250 is fitted incorrectly in the Grundfos E-pump.	Ensure that CIM 250 is fitted and connected correctly.
	b) CIM 250 is defective.	Replace CIM 250.
2. LED2 for internal communication is flashing red.	a) No internal communication between the CIM 250 and the Grundfos E-pump.	Ensure that the CIM 250 is fitted correctly in the Grundfos E-pump.
3. LED2 for internal communication is permanently red.	a) CIM 250 does not support the Grundfos E-pump connected.	Contact the nearest Grundfos company.
4. LED1 for GSM/GPRS communication is flashing yellow. See signal 1 in fig. 16 on page 12.	a) The SIM card has not been inserted.	Insert the SIM card. See section 6.1.2 Inserting the SIM card .
	b) The SIM card has not been inserted correctly.	Insert the SIM card. See section 6.1.2 Inserting the SIM card .
	c) The SIM card PIN code is not correct.	Enter the correct PIN code. See section 6.1.2 Inserting the SIM card .
	d) No connection to the GSM network.	<ul style="list-style-type: none"> • Check the connection to the antenna. • Check the GSM coverage of the area using for instance a mobile phone. • Use an external antenna and experiment with the position.
5. The LED1 for GSM/GPRS communication is pulsating yellow with single pulse, but CIM 250 cannot send or receive SMS messages.	a) CIM 250 has not been initialised.	Follow the configuration procedure in "CIM 25X SMS commands", supplement to installation and operating instructions, on the CD-ROM supplied with the GSM module.

14.2.2 CIM/CIU 250 Modbus GSM/GPRS communication faults

Fault	Possible cause	Remedy
1. The slave does not respond to telegrams.	a) Configuration or installation error.	<ul style="list-style-type: none"> Ensure that CIU 250 has contact with the GSM network. The LED1 must be pulsing yellow. If the LED1 signal is incorrect, see section 6. Modbus GSM/GPRS, CIM 250 setup for correct installation of the CIM 250. Ensure that the correct slave address is used in the Modbus master poll. See register 00003 SoftwareDefinedModbusAddress (factory value is 00231).
	b) The slave may be in listen-only mode.	Either send a restart communications diagnostics command, or restart the E-pump manually.
	c) If the holding register of address 00001 "SlaveMinimumReplyDelay" is set too high, the master may time out before receiving the response from the slave.	Increase the reply delay in the master, or reduce the "SlaveMinimumReplyDelay" in order to communicate.
2. The slave responds with exception response 0x01: "Invalid function".	a) The master is trying to use an unsupported function in CIM/CIU 250.	See section 13. Modbus RTU telegram examples for supported function codes. Note that reading and writing coils are not supported, so only register functions and diagnostics will be valid.
3. The slave responds with exception response 0x02: "Invalid data address".	a) The master is trying to read or write an invalid data address. If a master tries to read register addresses that are not listed in the tables, the slave will respond with this exception response. Some masters may automatically try to read large blocks in one telegram, which will cause problems if some of the registers in the block are not supported. An example would be reading the CIM configuration and CIM status register blocks in one telegram. This is not possible since there are unused addresses among the blocks.	Avoid reading or writing invalid data addresses. Make sure that register X is addressed as X - 1 in Modbus telegrams, according to the Modbus standard.
4. The slave returns data value 0xFFFF (65535).	a) The availability of data will in some cases depend on a configuration or the actual conditions of the system. For example trying to request data from an E-pump which is not present will return "data not available" (0xFFFF).	See section 9. Modbus register addresses for available data.
	b) With its present configuration or operating mode, the E-pump is unable to supply the requested data.	See section 9.7 Pump data register block for data values that require a sensor.
5. The slave does not react to control actions or to writing of settings.	a) CIU 250 is SCADA PIN-code-protected (GeneralStatus register 00029, bit 0 = 1), and an incorrect PIN code has been written.	Write access requires a correct PIN code (ScadaPinCode, register 00011). Writing the correct PIN code value triggers the write access control, and write access is open, which can be verified with GeneralStatus, register 00029, bit 1 = 1.

14.3 CIM/CIU 500

You can detect faults in CIU 500 by observing the status of the two communication LEDs. See the table below and section [4.4 CIM 500 Modbus TCP](#).

14.3.1 LED status

CIU 500 connected to an E-pump

Fault (LED status)	Possible cause	Remedy
1. Both LED1 and LED2 remain off when the power supply is connected.	a) CIM 500 is fitted incorrectly in the Grundfos product.	Check that CIM 500 is fitted and connected correctly.
	b) CIM 500 is defective.	Replace CIM 500.
2. LED2 for internal communication is flashing red.	a) No internal communication between CIM 500 and the Grundfos product.	Check that CIM 500 is fitted correctly in the Grundfos product.
3. LED2 for internal communication is permanently red.	a) CIM 500 does not support the Grundfos product connected.	Contact the nearest Grundfos company.
4. The Modbus LED1 is permanently red.	a) Fault in the CIM 500 Modbus TCP configuration.	Check that the rotary switch SW1 is set to 1. Check that Modbus TCP IP address configuration is correct. See section A.4 Modbus TCP configuration on page 52.
5. LED1 is permanently red and green at the same time.	a) Error in firmware download.	Use the webserver to download the firmware again.
6. LED2 is permanently red and green at the same time.	a) Memory fault.	Replace CIM 500.

CIM 500 fitted in CIU 500

Fault (LED status)	Possible cause	Remedy
1. Both LED1 and LED2 remain off when the power supply is connected.	a) CIU 500 is defective.	Replace CIU 500.
2. LED2 for internal communication is flashing red.	a) No internal communication between CIU 500 and the Grundfos product.	<ul style="list-style-type: none"> • Check the cable connection between the Grundfos product and CIU 500. • Check that the individual conductors have been fitted correctly, for example not reversed. • Check the power supply to the Grundfos product.
3. LED2 for internal communication is permanently red.	a) CIM 500 does not support the Grundfos product connected.	Contact the nearest Grundfos company.
4. The ethernet LED1 is permanently red.	a) Fault in the CIM 500 Modbus TCP configuration.	Check that the rotary switch SW1 is set to 1. Check that Modbus TCP IP address configuration is correct. See section A.4 Modbus TCP configuration on page 52.
5. LED1 is permanently red and green at the same time.	a) Error in firmware download.	Use the webserver to download the firmware again.
6. LED2 is permanently red and green at the same time.	a) Memory fault.	Replace CIM 500.

14.3.2 CIM/CIU 500 Modbus TCP communication faults

Fault	Possible cause	Remedy
1. The slave does not respond to telegrams.	a) Configuration or wiring error.	<ul style="list-style-type: none"> Check the visual diagnostics on the Modbus slave. Normal conditions are that the Grundfos GENibus LED2 is permanently green and that the Modbus TCP LED1 is off or flashing green. If not, see section 14.3.1 LED status. Make sure that the cable between the Modbus TCP master and the Modbus slave is connected correctly. See section 7.1 Connecting the ethernet cable. Ensure that the slave IP address is configured correctly, and that the correct slave IP address is used in the Modbus master poll. See section 7.3 Setting the IP addresses.
2. The slave responds with exception response 0x01 "Invalid function".	a) The master is trying to use an unsupported function in CIM/CIU 500.	See section 8. Modbus function code overview . Modbus function code overview for supported function codes. Note that reading and writing coils are not supported, so only register functions and diagnostics are valid.
3. The slave responds with exception response 0x02 "Invalid data address".	a) The master is trying to read or write an invalid data address. If a master tries to read register addresses that are not listed in the tables, the slave will respond with this exception response. Some masters may automatically try to read large blocks in one telegram, which will cause problems if some of the registers in the block are not supported. An example would be reading the CIM configuration and CIM status blocks in one telegram. This is not possible since there are unused addresses between the blocks.	Avoid reading or writing invalid data addresses. Ensure that a block of registers starting at address X is addressed as X - 1 in Modbus telegrams, according to the Modbus standard.
	b) The register address offset may have been changed from default.	Read the holding register at address 00002 "Register Offset" to see if this value is different from 0. If so, write the value 0 to this address to make the slave return to the default used in this functional profile.
4. The slave returns data value 0xFFFF (65535).	a) The value is unavailable. A data value of 0xFFFF does not necessarily indicate an error condition. It means that the value is unavailable from the E-pump.	See section 9. Modbus register addresses for available data.
	b) The E-pump is not configured to show the value or lacks a sensor to read the value.	See section 9.7 Pump data register block for data values that require a sensor.
5. The slave does not react to control actions or to writing of settings.	a) The E-pump might be in "Local" mode, in which case Operating mode, Control mode and Setpoint cannot be changed from bus. Register 00201 bit 8 AccessMode must be "1" (=Remote) for bus control to be active.	Set the E-pump in "Remote mode" by setting register 00101 bit 0 RemoteAccessReq to "1" (= Remote). The E-pump should show "Controlled from bus" when status is read in Grundfos GO Remote.

15. Modbus RTU rotary switch addresses

Modbus address	SW6	SW7	Modbus address	SW6	SW7	Modbus address	SW6	SW7	Modbus address	SW6	SW7	Modbus address	SW6	SW7
1	0	1	51	3	3	101	6	5	151	9	7	201	C	9
2	0	2	52	3	4	102	6	6	152	9	8	202	C	A
3	0	3	53	3	5	103	6	7	153	9	9	203	C	B
4	0	4	54	3	6	104	6	8	154	9	A	204	C	C
5	0	5	55	3	7	105	6	9	155	9	B	205	C	D
6	0	6	56	3	8	106	6	A	156	9	C	206	C	E
7	0	7	57	3	9	107	6	B	157	9	D	207	C	F
8	0	8	58	3	A	108	6	C	158	9	E	208	D	0
9	0	9	59	3	B	109	6	D	159	9	F	209	D	1
10	0	A	60	3	C	110	6	E	160	A	0	210	D	2
11	0	B	61	3	D	111	6	F	161	A	1	211	D	3
12	0	C	62	3	E	112	7	0	162	A	2	212	D	4
13	0	D	63	3	F	113	7	1	163	A	3	213	D	5
14	0	E	64	4	0	114	7	2	164	A	4	214	D	6
15	0	F	65	4	1	115	7	3	165	A	5	215	D	7
16	1	0	66	4	2	116	7	4	166	A	6	216	D	8
17	1	1	67	4	3	117	7	5	167	A	7	217	D	9
18	1	2	68	4	4	118	7	6	168	A	8	218	D	A
19	1	3	69	4	5	119	7	7	169	A	9	219	D	B
20	1	4	70	4	6	120	7	8	170	A	A	220	D	C
21	1	5	71	4	7	121	7	9	171	A	B	221	D	D
22	1	6	72	4	8	122	7	A	172	A	C	222	D	E
23	1	7	73	4	9	123	7	B	173	A	D	223	D	F
24	1	8	74	4	A	124	7	C	174	A	E	224	E	0
25	1	9	75	4	B	125	7	D	175	B	F	225	E	1
26	1	A	76	4	C	126	7	E	176	B	0	226	E	2
27	1	B	77	4	D	127	7	F	177	B	1	227	E	3
28	1	C	78	4	E	128	8	0	178	B	2	228	E	4
29	1	D	79	4	F	129	8	1	179	B	3	229	E	5
30	1	E	80	5	0	130	8	2	180	B	4	230	E	6
31	1	F	81	5	1	131	8	3	181	B	5	231	E	7
32	2	0	82	5	2	132	8	4	182	B	6	232	E	8
33	2	1	83	5	3	133	8	5	183	B	7	233	E	9
34	2	2	84	5	4	134	8	6	184	B	8	234	E	A
35	2	3	85	5	5	135	8	7	185	B	9	235	E	B
36	2	4	86	5	6	136	8	8	186	B	A	236	E	C
37	2	5	87	5	7	137	8	9	187	B	B	237	E	D
38	2	6	88	5	8	138	8	A	188	B	C	238	E	E
39	2	7	89	5	9	139	8	B	189	B	D	239	E	F
40	2	8	90	5	A	140	8	C	190	B	E	240	F	0
41	2	9	91	5	B	141	8	D	191	B	F	241	F	1
42	2	A	92	5	C	142	8	E	192	C	0	242	F	2
43	2	B	93	5	D	143	8	F	193	C	1	243	F	3
44	2	C	94	5	E	144	9	0	194	C	2	244	F	4
45	2	D	95	5	F	145	9	1	195	C	3	245	F	5
46	2	E	96	6	0	146	9	2	196	C	4	246	F	6
47	2	F	97	6	1	147	9	3	197	C	5	247	F	7
48	3	0	98	6	2	148	9	4	198	C	6			
49	3	1	99	6	3	149	9	5	199	C	7			
50	3	2	100	6	4	150	9	6	200	C	8			

Example: To set the slave address to the value 142, set the rotary switches SW6 and SW7 to "8" and "E", respectively.

Please note that 0 is not a valid slave address as this is used for broadcasting.



It is very important to ensure that two devices do not have the same address on the network. If two devices have the same address, the result will be an abnormal behaviour of the whole serial bus.

16. Grundfos alarm and warning codes

This is a complete list of alarm and warning codes for Grundfos products. For the codes supported by this product, see the alarms and warnings section.

Code	Description	Code	Description	Code	Description
1	Leakage current	36	Outlet valve leakage	71	Motor temperature 2 (Pt100, t_mo2)
2	Missing phase	37	Inlet valve leakage	72	Hardware fault, type 1
3	External fault signal	38	Vent valve defective	73	Hardware shutdown (HSD)
4	Too many restarts	39	Valve stuck or defective	74	Internal supply voltage too high
5	Regenerative braking	40	Undervoltage	75	Internal supply voltage too low
6	Mains fault	41	Undervoltage transient	76	Internal communication fault
7	Too many hardware shutdowns	42	Cut-in fault (dV/dt)	77	Communication fault, twin-head pump
8	PWM switching frequency reduced	43	-	78	Fault, speed plug
9	Phase sequence reversal	44	-	79	Functional fault, add-on module
10	Communication fault, pump	45	Voltage asymmetry	80	Hardware fault, type 2
11	Water-in-oil fault (motor oil)	46	-	81	Verification error, data area (RAM)
12	Time for service (general service information)	47	-	82	Verification error, code area (ROM, FLASH)
13	Moisture alarm, analog	48	Overload	83	Verification error, FE parameter area (EEPROM)
14	Electronic DC-link protection activated (ERP)	49	Overcurrent (i_line, i_dc, i_mo)	84	Memory access error
15	Communication fault, main system (SCADA)	50	Motor protection function, general shutdown (MPF)	85	Verification error, BE parameter area (EEPROM)
16	Other	51	Blocked motor or pump	86	Fault (add-on) I/O module
17	Performance requirement cannot be met	52	Motor slip high	87	-
18	Commanded alarm standby (trip)	53	Stalled motor	88	Sensor fault
19	Diaphragm break (dosing pump)	54	Motor protection function, 3 sec. limit	89	Signal fault, (feedback) sensor 1
20	Insulation resistance low	55	Motor current protection activated (MCP)	90	Signal fault, speed sensor
21	Too many starts per hour	56	Underload	91	Signal fault, temperature sensor 1
22	Moisture switch alarm, digital	57	Dry running	92	Calibration fault, (feedback) sensor
23	Smart trim gap alarm	58	Low flow	93	Signal fault, sensor 2
24	Vibration	59	No flow	94	Limit exceeded, sensor 1
25	Setup conflict	60	Low input power	95	Limit exceeded, sensor 2
26	Load continues even if the motor has been switched off	61	-	96	Setpoint signal outside range
27	External motor protector activated (for example MP 204)	62	-	97	Signal fault, setpoint input
28	Battery low	63	-	98	Signal fault, input for setpoint influence
29	Turbine operation (impellers forced backwards)	64	-	99	Signal fault, input for analog setpoint
30	Change bearings (specific service information)	65	Motor temperature 1 (t_m or t_mo or t_mo1)	100	RTC time synchronisation with GSM occurred
31	Change varistor(s) (specific service information)	66	Temperature, control electronics (t_e)	101	-
32	Overvoltage	67	Temperature too high, internal frequency converter module (t_m)	102	Dosing pump not ready
33	Soon time for service (general service information)	68	External temperature or water temperature (t_w)	103	Emergency stop
34	No priming water	69	Thermal relay 1 in motor, for example Klixon	104	Software shutdown
35	Gas in pump head, deaerating problem	70	Thermal relay 2 in motor, for example thermistor	105	Electronic rectifier protection activated (ERP)

Code	Description	Code	Description	Code	Description
106	Electronic inverter protection activated (EIP)	141	-	176	Signal fault, temperature sensor 3 (t_mo3)
107	-	142	-	177	Signal fault, Smart trim gap sensor
108	-	143	-	178	Signal fault, vibration sensor
109	-	144	Motor temperature 3 (Pt100, t_mo3)	179	Signal fault, bearing temperature sensor (Pt100), general or top bearing
110	Skew load, electrical asymmetry	145	Bearing temperature high (Pt100), in general or top bearing	180	Signal fault, bearing temperature sensor (Pt100), middle bearing
111	Current asymmetry	146	Bearing temperature high (Pt100), middle bearing	181	Signal fault, PTC sensor (short circuited)
1112	Cosφ too high	147	Bearing temperature high (Pt100), bottom bearing	182	Signal fault, bearing temperature sensor (Pt100), bottom bearing
113	Cosφ too low	148	Motor bearing temperature high (Pt100) in drive end (DE)	183	Signal fault, extra temperature sensor
114	Motor heater function activated (frost protection)	149	Motor bearing temperature high (Pt100) in non-drive end (NDE)	184	Signal fault, general-purpose sensor
115	Too many grinder reversals or grinder reversal attempt failed	150	Fault (add-on) pump module	185	Unknown sensor type
116	Grinder motor over temperature	151	Fault, display (HMI)	186	Signal fault, power meter sensor
117	Intrusion (door opened)	152	Communication fault, add-on module	187	Signal fault, energy meter
118	Signal fault, hydrogen sulfide H2S sensor	153	Fault, analog output	188	Signal fault, user-defined sensor
119	Signal fault, analog input AI4	154	Communication fault, display	189	Signal fault, level sensor
120	Auxiliary winding fault (single phase motors)	155	Inrush fault	190	Limit exceeded, sensor 1 (for example alarm level in WW application)
121	Auxiliary winding current too high (single-phase motors)	156	Communication fault, internal frequency converter module	191	Limit exceeded, sensor 2 (for example high level in WW application)
122	Auxiliary winding current too low (single-phase motors)	157	Real-time clock out of order	192	Limit exceeded, sensor 3 (for example overflow level in WW application)
123	Start capacitor, low (single-phase motors)	158	Hardware circuit measurement fault	193	Limit exceeded, sensor 4 (for example low level in WW/tank filling application)
124	Run capacitor, low (single-phase motors)	159	CIM fault (Communication Interface Module)	194	Limit exceeded, sensor 5
125	Signal fault, outdoor temperature sensor	160	GSM modem, SIM card fault	195	Limit exceeded, sensor 6
126	Signal fault, air temperature sensor	161	Sensor supply fault, 5 V	196	Operation with reduced efficiency
127	Signal fault, shunt relative pressure sensor	162	Sensor supply fault, 24 V	197	Operation with reduced pressure
128	Strainer clogged	163	Measurement fault, motor protection	198	Operation with increased power consumption
129	-	164	Signal fault, LiqTec sensor	199	Process out of range (monitoring, estimation, calculation, control)
130	-	165	Signal fault, analog input 1	200	Application alarm
131	-	166	Signal fault, analog input 2	201	External sensor input high
132	-	167	Signal fault, analog input 3	202	External sensor input low
133	-	168	Signal fault, pressure sensor	203	Alarm on all pumps
134	-	169	Signal fault, flow sensor	204	Inconsistency between sensors
135	-	170	Signal fault, water-in-oil (WIO) sensor	205	Level float switch sequence inconsistency
136	-	171	Signal fault, moisture sensor	206	Water shortage, level 1
137	-	172	Signal fault, atmospheric pressure sensor	207	Water leakage
138	-	173	Signal fault, rotor position sensor (Hall sensor)	208	Cavitation
139	-	174	Signal fault, rotor origo sensor	209	Non-return valve fault
140	-	175	Signal fault, temperature sensor 2 (t_mo2)	210	High pressure

Code	Description	Code	Description	Code	Description
211	Low pressure	226	Communication fault, I/O module	241	Motor phase failure
212	Diaphragm tank precharge pressure out of range	227	Combi event	242	Automatic motor model recognition failed
213	VFD not ready	228	Night flow max. limit exceeded	243	Motor relay has been forced (manually operated or commanded)
214	Water shortage, level 2	229	Water on floor	244	Fault, On/Off/Auto switch
215	Soft pressure build-up time-out	230	Network alarm	245	Pump continuous runtime too long
216	Pilot pump alarm	231	Ethernet: No IP address from DHCP server	246	User-defined relay has been forced (manually operated or commanded)
217	Alarm, general-purpose sensor high	232	Ethernet: Auto-disabled due to misuse	247	Power-on notice, (device or system has been switched off)
218	Alarm, general-purpose sensor low	233	Ethernet: IP address conflict	248	Fault, battery/UPS
219	Pressure relief not adequate	234	Backup pump alarm	249	User-defined event 1
220	Fault, motor contactor feedback	235	Gas detected	250	User-defined event 2
221	Fault, mixer contactor feedback	236	Pump 1 fault	251	User-defined event 3
222	Time for service, mixer	237	Pump 2 fault	252	User-defined event 4
223	Time for service, mixer	238	Pump 3 fault	253	SMS data from DDD sensor not received within time
224	Pump fault, due to auxiliary component or general fault	239	Pump 4 fault	254	Inconsistent data model
225	Communication fault, pump module	240	Lubricate bearings (specific service information)		

Appendix

The appendix describes the parts of the CIM 500 webserver needed for the configuration of a Modbus TCP ethernet connection. For other CIM 500 webserver features, not specifically related to Modbus TCP, see the installation and operating instructions for CIM 500.

A.1 How to configure an IP address on your PC

For connecting a PC to CIM 500 via ethernet, the PC must be set to use a fixed (static) IP address belonging to the same subnetwork as CIM 500.

1. Open "Control Panel".
2. Enter "Network and Sharing Center".
3. Click "Change adapter settings".
4. Right-click and select "Properties" for ethernet adapter. Typically "Local Area Connection".
5. Select properties for "Internet Protocol Version 4(TCP/IPv4).
6. Select the "Alternate Configuration" tab.
7. Configure an IP address and subnet mask to be used by your PC. See fig. 1.

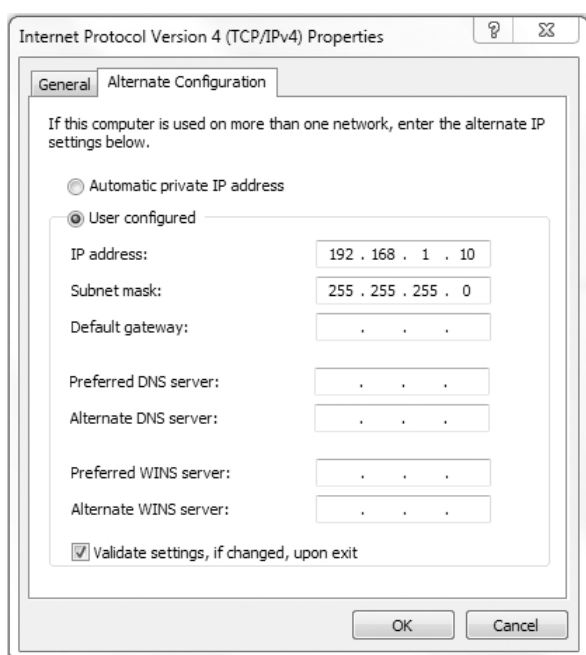

TM05 7422 1814

Fig. 1 Example from Windows

A.2 Webserver configuration

The built-in webserver is an easy and effective way to monitor the status of CIM 500 and configure the available functions and Industrial Ethernet protocols. The webserver also makes it possible to update the firmware of CIM 500, and store or restore settings.

To establish a connection from a PC to CIM 500, proceed as follows:

Before configuration

- Check that the PC and CIM 500 are connected via an ethernet cable.
- Check that the PC ethernet port is set to the same network as the CIM 500. For network configuration, see section [A.1 How to configure an IP address on your PC](#).

To establish a connection from a PC to CIM 500 for the first time, the following steps are required:

1. Open a standard Internet browser and type 192.168.1.100 in the URL address field.
2. Log in to the webserver.

A.3 Login

Fig. 2 Login

User name	Enter user name. Default: admin.
-----------	----------------------------------

Password	Enter password. Default: Grundfos.
----------	------------------------------------



User name and password can be changed on the webserver under "User Management".

A.4 Modbus TCP configuration

Fig. 3 Real Time Ethernet Protocol Configuration - Modbus TCP

Object	Description
TCP Port Number	The default value is 502, the official IANA-assigned Modbus TCP port number. Number 502 will always be active implicitly. If you select another value in the webserver configuration field, both the new value and value 502 will be active.
IP Address	The static IP address for CIM 500 on the Modbus TCP network. It must be unique.
Subnet Mask	The subnet mask for the CIM 500 module on the Modbus TCP network.
Gateway	The default gateway for the Modbus TCP network.
Use DHCP	The CIM 500 module can be configured to automatically obtain the IP address from a DHCP server on the network.

Argentina

Bombas GRUNDFOS de Argentina S.A.
Ruta Panamericana km. 37.500 Centro
Industrial Garin
1619 Garin Pcia. de B.A.
Phone: +54-3327 414 444
Telefax: +54-3327 45 3190

Australia

GRUNDFOS Pumps Pty. Ltd.
P.O. Box 2040
Regency Park
South Australia 5942
Phone: +61-8-8461-4611
Telefax: +61-8-8340 0155

Austria

GRUNDFOS Pumpen Vertrieb Ges.m.b.H.
Grundfosstraße 2
A-5082 Grödig/Salzburg
Tel.: +43-6246-883-0
Telefax: +43-6246-883-30

Belgium

N.V. GRUNDFOS Bellux S.A.
Boomssesteenweg 81-83
B-2630 Aartselaar
Tél.: +32-3-870 7300
Télécopie: +32-3-870 7301

Belarus

Представительство ГРУНДФОС в
Минске
220125, Минск
ул. Шафарнянская, 11, оф. 56, БЦ
«Порт»
Тел.: +7 (375 17) 286 39 72/73
Факс: +7 (375 17) 286 39 71
E-mail: minsk@grundfos.com

Bosnia and Herzegovina

GRUNDFOS Sarajevo
Zmaja od Bosne 7-7A,
BH-71000 Sarajevo
Phone: +387 33 592 480
Telefax: +387 33 590 465
www.ba.grundfos.com
e-mail: grundfos@bih.net.ba

Brazil

BOMBAS GRUNDFOS DO BRASIL
Av. Humberto de Alencar Castelo Branco,
630
CEP 09850 - 300
São Bernardo do Campo - SP
Phone: +55-11 4393 5533
Telefax: +55-11 4343 5015

Bulgaria

Grundfos Bulgaria EOOD
Slatina District
Iztochna Tangenta street no. 100
BG - 1592 Sofia
Tel. +359 2 49 22 200
Fax. +359 2 49 22 201
email: bulgaria@grundfos.bg

Canada

GRUNDFOS Canada Inc.
2941 Brighton Road
Oakville, Ontario
L6H 6C9
Phone: +1-905 829 9533
Telefax: +1-905 829 9512

China

GRUNDFOS Pumps (Shanghai) Co. Ltd.
10F The Hub, No. 33 Suhong Road
Minhang District
Shanghai 201106
PRC
Phone: +86 21 612 252 22
Telefax: +86 21 612 253 33

COLOMBIA

GRUNDFOS Colombia S.A.S.
Km 1.5 vía Siberia-Cota Conj. Potrero
Chico,
Parque Empresarial Arcos de Cota Bod.
1A.
Cota, Cundinamarca
Phone: +57(1)-2913444
Telefax: +57(1)-8764586

Croatia

GRUNDFOS CROATIA d.o.o.
Buzinski prilaz 38, Buzin
HR-10010 Zagreb
Phone: +385 1 6595 400
Telefax: +385 1 6595 499
www.hr.grundfos.com

GRUNDFOS Sales Czechia and

Slovakia s.r.o.
Čajkovského 21
779 00 Olomouc
Phone: +420-585-716 111

Denmark

GRUNDFOS DK A/S
Martin Bachs Vej 3
DK-8850 Bjerringbro
Tlf.: +45-87 50 50 50
Telefax: +45-87 50 51 51
E-mail: info_GDK@grundfos.com
www.grundfos.com/DK

Estonia

GRUNDFOS Pumps Eesti OÜ
Peterburi tee 92G
11415 Tallinn
Tel: + 372 606 1690
Fax: + 372 606 1691

Finland

OY GRUNDFOS Pumpat AB
Trukkikuja 1
FI-01360 Vantaa
Phone: +358-(0) 207 889 500

France

Pompes GRUNDFOS Distribution S.A.
Parc d'Activités de Chesnes
57, rue de Malacombe
F-38290 St. Quentin Fallavier (Lyon)
Tél.: +33-4 74 82 15 15
Télécopie: +33-4 74 94 10 51

Germany

GRUNDFOS GMBH
Schlüterstr. 33
40699 Erkrath
Tel.: +49-(0) 211 929 69-0
Telefax: +49-(0) 211 929 69-3799
e-mail: infoservice@grundfos.de
Service in Deutschland:
e-mail: kundendienst@grundfos.de

Greece

GRUNDFOS Hellas A.E.B.E.
20th km. Athinon-Markopoulou Av.
P.O. Box 71
GR-19002 Peania
Phone: +0030-210-66 83 400
Telefax: +0030-210-66 46 273

Hong Kong

GRUNDFOS Pumps (Hong Kong) Ltd.
Unit 1, Ground floor
Siu Wai Industrial Centre
29-33 Wing Hong Street &
68 King Lam Street, Cheung Sha Wan
Kowloon
Phone: +852-27861706 / 27861741
Telefax: +852-27858664

Hungary

GRUNDFOS Hungária Kft.
Tópark u. 8
H-2045 Törökbálint,
Phone: +36-23 511 110
Telefax: +36-23 511 111

India

GRUNDFOS Pumps India Private Limited
118 Old Mahabalipuram Road
Thoraiakkam
Chennai 600 096
Phone: +91-44 2496 6800

Indonesia

PT. GRUNDFOS POMPA
Graha Intirub Lt. 2 & 3
Jln. Cililitan Besar No.454. Makasar,
Jakarta Timur
ID-Jakarta 13650
Phone: +62 21-469-51900
Telefax: +62 21-460 6910 / 460 6901

Ireland

GRUNDFOS (Ireland) Ltd.
Unit A, Merrywell Business Park
Ballymount Road Lower
Dublin 12
Phone: +353-1-4089 800
Telefax: +353-1-4089 830

Italy

GRUNDFOS Pompe Italia S.r.l.
Via Gran Sasso 4
I-20060 Truccazzano (Milano)
Tel.: +39-02-95838112
Telefax: +39-02-95309290 / 95838461

Japan

GRUNDFOS Pumps K.K.
1-2-3, Shin-Miyakoda, Kita-ku,
Hamamatsu
431-2103 Japan
Phone: +81 53 428 4760
Telefax: +81 53 428 5005

Korea

GRUNDFOS Pumps Korea Ltd.
6th Floor, Aju Building 679-5
Yeoksam-dong, Kangnam-ku, 135-916
Seoul, Korea
Phone: +82-2-5317 600
Telefax: +82-2-5633 725

Latvia

SIA GRUNDFOS Pumps Latvia
Deglava biznesa centrs
Augusta Deglava ielā 60, LV-1035, Rīga,
Tālr.: + 371 714 9640, 7 149 641
Fakss: + 371 914 9646

Lithuania

GRUNDFOS Pumps UAB
Smolensko g. 6
LT-03201 Vilnius
Tel: + 370 52 395 430
Fax: + 370 52 395 431

Malaysia

GRUNDFOS Pumps Sdn. Bhd.
7 Jalan Peguam U1/25
Glenmarie Industrial Park
40150 Shah Alam
Selangor
Phone: +60-3-5569 2922
Telefax: +60-3-5569 2866

Mexico

Bombas GRUNDFOS de México S.A. de
C.V.
Boulevard TLC No. 15
Parque Industrial Stiva Aeropuerto
Apodaca, N.L. 66600
Phone: +52-81-8144 4000
Telefax: +52-81-8144 4010

Netherlands

GRUNDFOS Netherlands
Veluwezoom 35
1326 AE Almere
Postbus 22015
1302 CA ALMERE
Tel.: +31-88-478 6336
Telefax: +31-88-478 6332
E-mail: info_gnl@grundfos.com

New Zealand

GRUNDFOS Pumps NZ Ltd.
17 Beatrice Tinsley Crescent
North Harbour Industrial Estate
Albany, Auckland
Phone: +64-9-415 3240
Telefax: +64-9-415 3250

Norway

GRUNDFOS Pumper A/S
Strømsveien 344
Postboks 235, Leirdal
N-1011 Oslo
Tlf.: +47-22 90 47 00
Telefax: +47-22 32 21 50

Poland

GRUNDFOS Pompy Sp. z o.o.
ul. Klonowa 23
Baranowo k. Poznania
PL-62-081 Przeźmierowo
Tel: (+48-61) 650 13 00
Fax: (+48-61) 650 13 50

Portugal

Bombas GRUNDFOS Portugal, S.A.
Rua Calvet de Magalhães, 241
Apartado 1079
P-2770-153 Paço de Arcos
Tel.: +351-21-440 76 00
Telefax: +351-21-440 76 90

Romania

GRUNDFOS Pompe România SRL
Bd. Biruintei, nr 103
Pantelimon county Ilfov
Phone: +40 21 200 4100
Telefax: +40 21 200 4101
E-mail: romania@grundfos.ro

Russia

ООО Грундфос Россия
ул. Школьная, 39-41
Москва, RU-109544, Russia
Тел. (+7) 495 564-88-00 (495) 737-30-00
Факс (+7) 495 564 8811
E-mail grundfos.moscow@grundfos.com

Serbia

Grundfos Srbija d.o.o.
Omladinskih brigada 90b
11070 Novi Beograd
Phone: +381 11 2258 740
Telefax: +381 11 2281 769
www.rs.grundfos.com

Singapore

GRUNDFOS (Singapore) Pte. Ltd.
25 Jalan Tukang
Singapore 619264
Phone: +65-6681 9688
Telefax: +65-6681 9689

Slovakia

GRUNDFOS s.r.o.
Prievozská 4D
821 09 BRATISLAVA
Phona: +421 2 5020 1426
sk.grundfos.com

Slovenia

GRUNDFOS LJUBLJANA, d.o.o.
Leskoškova 9e, 1122 Ljubljana
Phone: +386 (0) 1 568 06 10
Telefax: +386 (0)1 568 06 19
E-mail: tehniksi@grundfos.com

South Africa

GRUNDFOS (PTY) LTD
Corner Mountjoy and George Allen Roads
Wilbart Ext. 2
Bedfordview 2008
Phone: (+27) 11 579 4800
Fax: (+27) 11 455 6066
E-mail: lsmart@grundfos.com

Spain

Bombas GRUNDFOS España S.A.
Camino de la Fuentequilla, s/n
E-28110 Algete (Madrid)
Tel.: +34-91-848 8800
Telefax: +34-91-628 0465

Sweden

GRUNDFOS AB
Box 333 (Lunnagårdsgatan 6)
431 24 Mölndal
Tel.: +46 31 332 23 000
Telefax: +46 31 331 94 60

Switzerland

GRUNDFOS Pumpen AG
Bruggacherstrasse 10
CH-8117 Fällanden/ZH
Tel.: +41-44-806 8111
Telefax: +41-44-806 8115

Taiwan

GRUNDFOS Pumps (Taiwan) Ltd.
7 Floor, 219 Min-Chuan Road
Taichung, Taiwan, R.O.C.
Phone: +886-4-2305 0868
Telefax: +886-4-2305 0878

Thailand

GRUNDFOS (Thailand) Ltd.
92 Chaloen Phrakiat Rama 9 Road,
Dokmai, Pravej, Bangkok 10250
Phone: +66-2-725 8999
Telefax: +66-2-725 8998

Turkey

GRUNDFOS POMPA San. ve Tic. Ltd. Sti.
Gebze Organize Sanayi Bölgesi
İhsan dede Caddesi,
2. yol 200. Sokak No. 204
41490 Gebze/ Kocaeli
Phone: +90 - 262-679 7979
Telefax: +90 - 262-679 7905
E-mail: satis@grundfos.com

Ukraine

Бізнес Центр Європа
Столичне шосе, 103
м. Київ, 03131, Україна
Телефон: (+38 044) 237 04 00
Факс.: (+38 044) 237 04 01
E-mail: ukraine@grundfos.com

United Arab Emirates

GRUNDFOS Gulf Distribution
P.O. Box 16768
Jebel Ali Free Zone
Dubai
Phone: +971 4 8815 166
Telefax: +971 4 8815 136

United Kingdom

GRUNDFOS Pumps Ltd.
Grovebury Road
Leighton Buzzard/Beds. LU7 4TL
Phone: +44-1525-850000
Telefax: +44-1525-850011

U.S.A.

GRUNDFOS Pumps Corporation
17100 West 118th Terrace
Olathe, Kansas 66061
Phone: +1-913-227-3400
Telefax: +1-913-227-3500

Uzbekistan

Grundfos Tashkent, Uzbekistan The Repre-
sentative Office of Grundfos Kazakhstan in
Uzbekistan
38a, Oybek street, Tashkent
Телефон: (+998) 71 150 3290 / 71 150
3291
Факс: (+998) 71 150 3292

Addresses Revised 14.03.2018

98367081 0418

ECM: 1222615
