



SMART Digital S

DDA/DDC

DDA \leq 30 l/h (8 gph)

DDC \leq 15 l/h (4 gph)

Installation and
operating instructions DDA



net.grundfos.com/qr/i/95724708

Installation and
operating instructions DDC



net.grundfos.com/qr/i/95726994

be
think
innovate

GRUNDFOS 

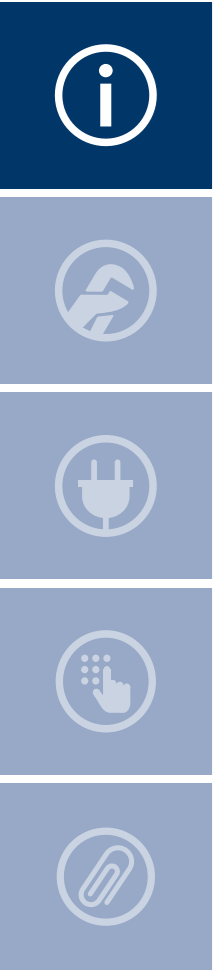

i

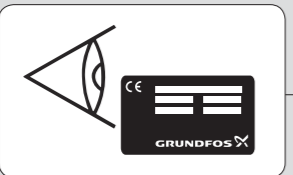

Min./Max.
-10 °C / +45 °C
14 °F / 113 °F

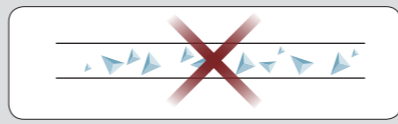

Min./Max.
0 °C / +45 °C
32 °F / 113 °F

≤ 60 dB(A)

IP 65
(Nema 4x)



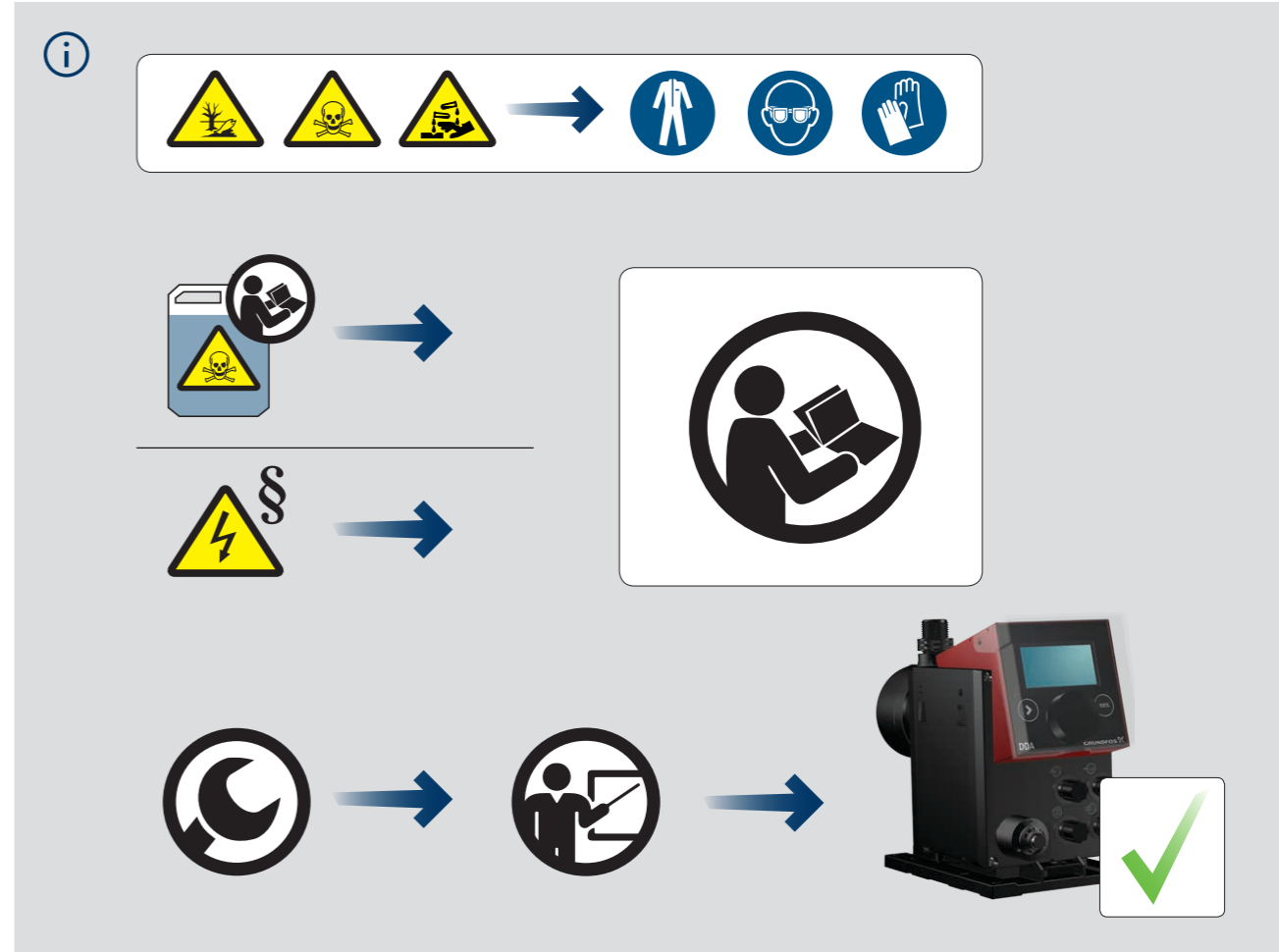
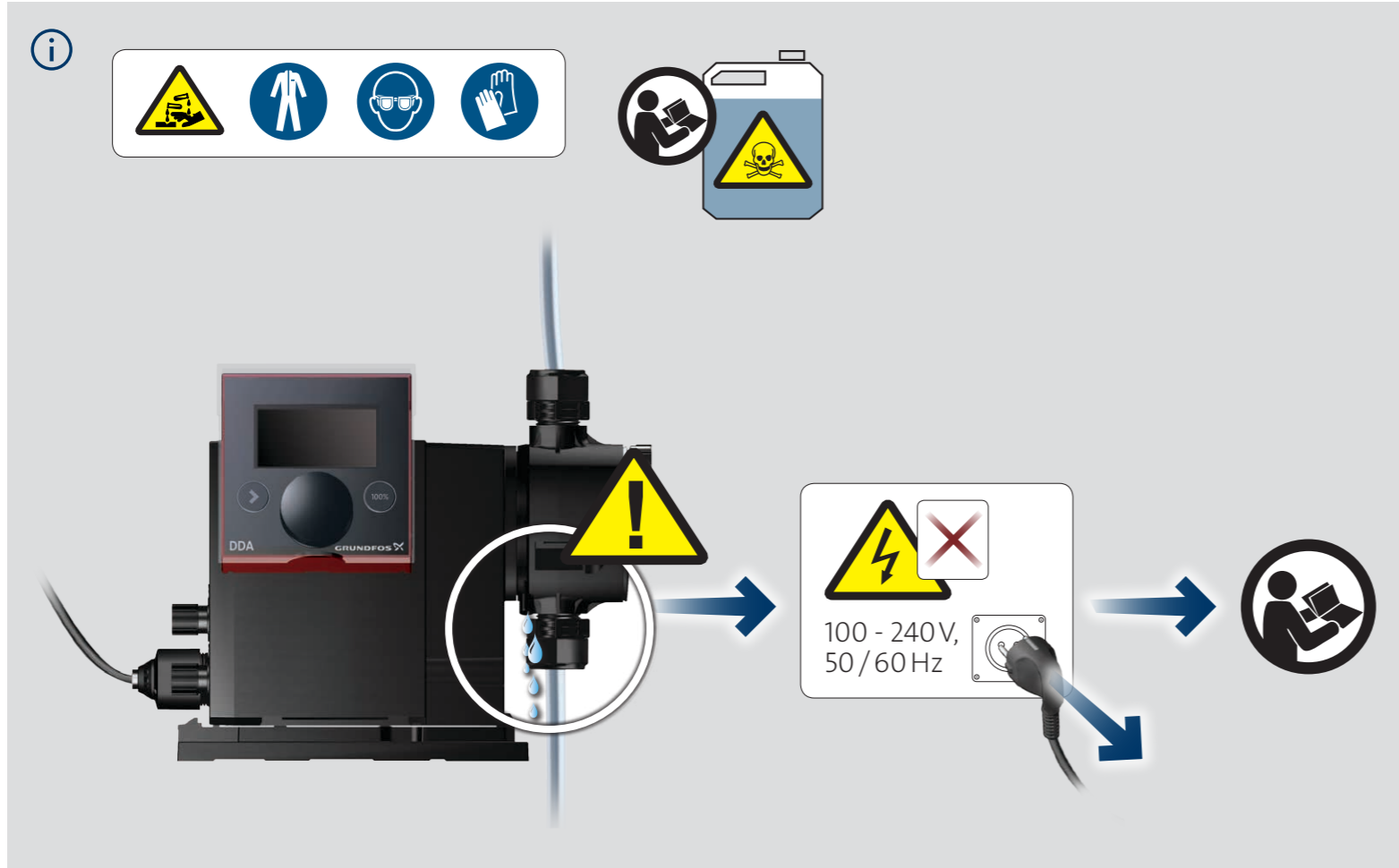
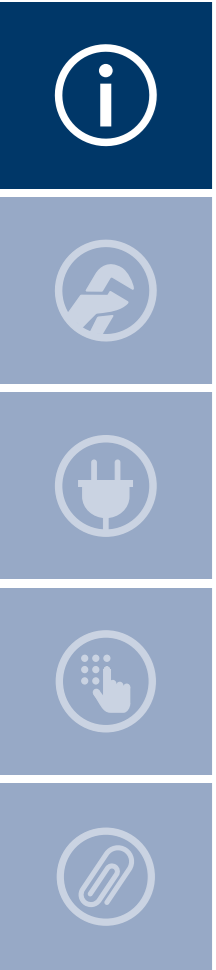

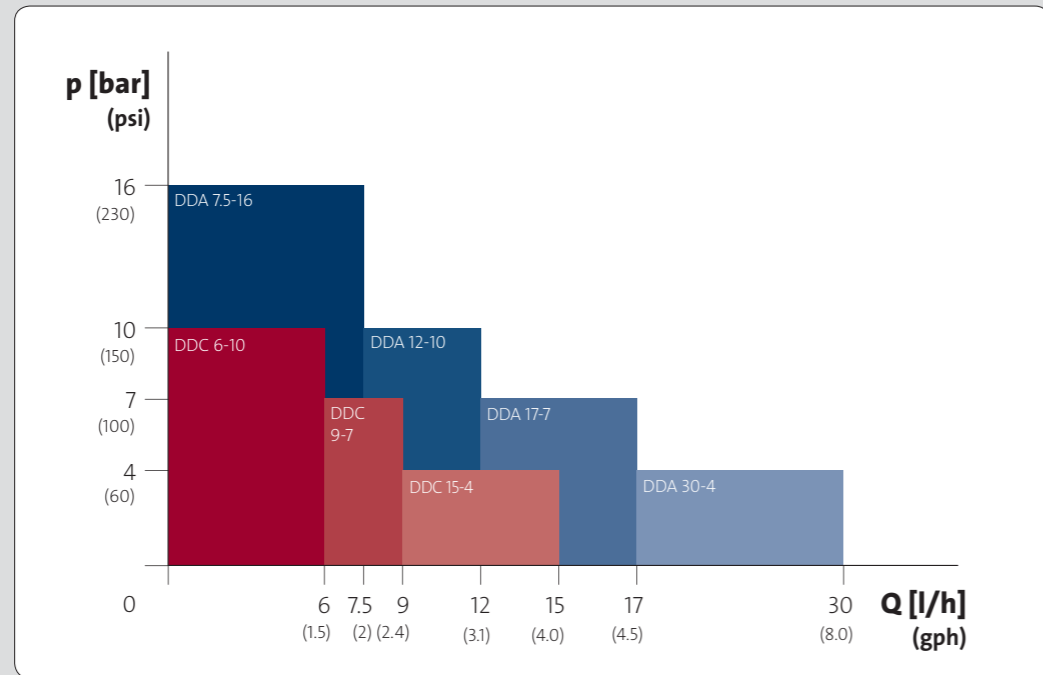

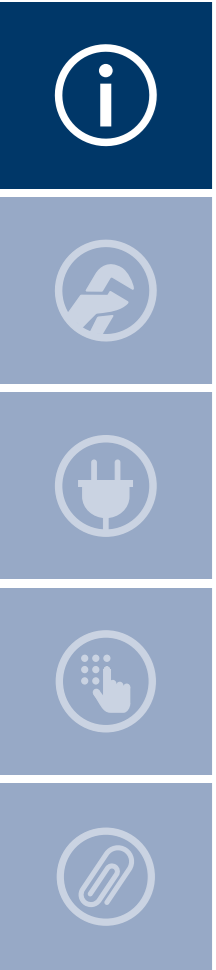



i

 100 - 240V,
50/60 Hz 





Max.
1.5 m/59"

Min.
100 mm/4"



Min.
100 mm/4"

 Max.
4 kg/8.8 lb 



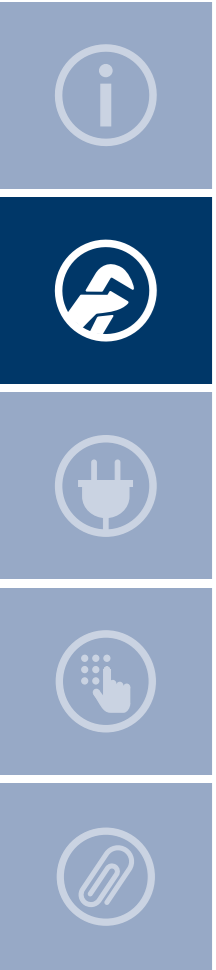

1

TORX PLUS (15 IP)



2

STOP

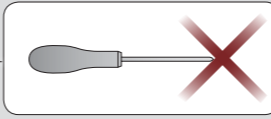

3



4

TORX PLUS (15 IP)



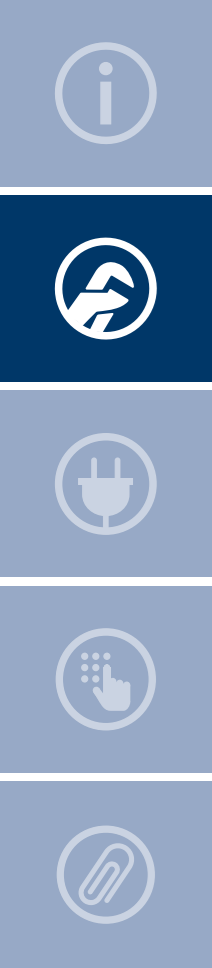

5



6a

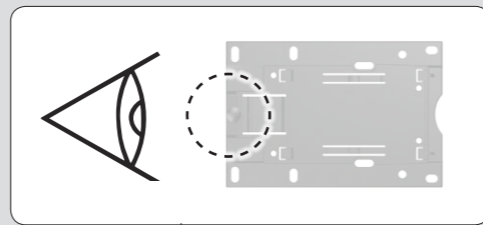

7a



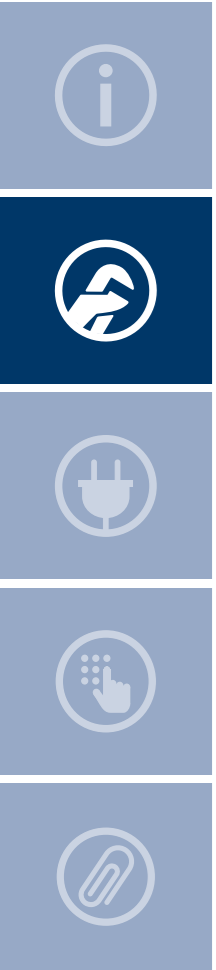

6b

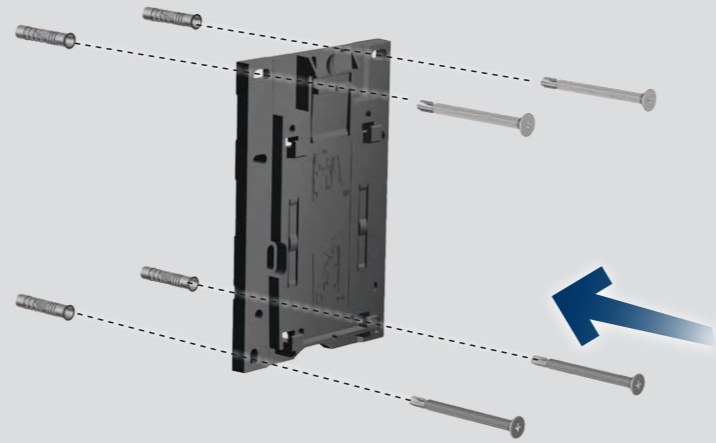
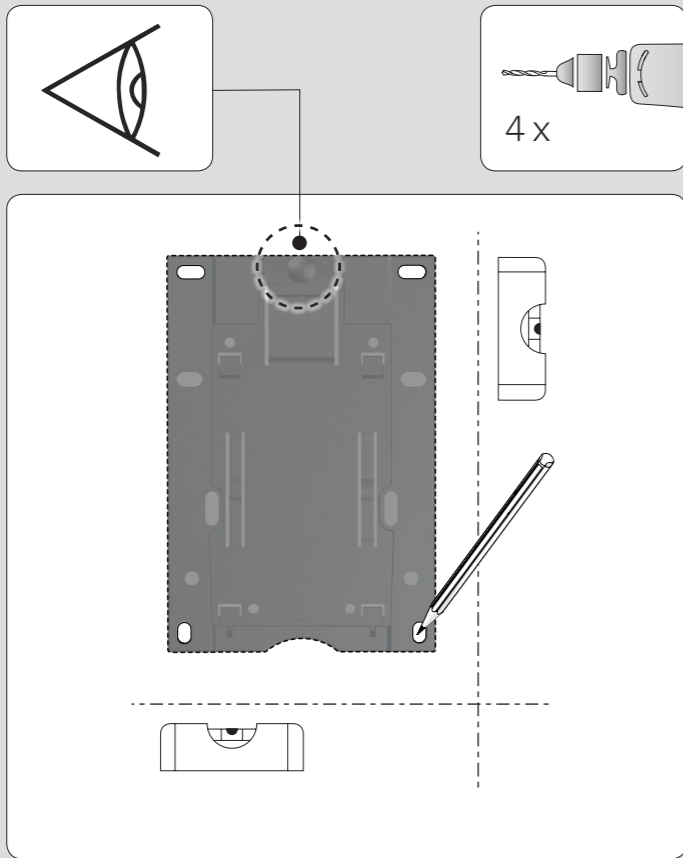

Ø 5 mm (0.2")

7b

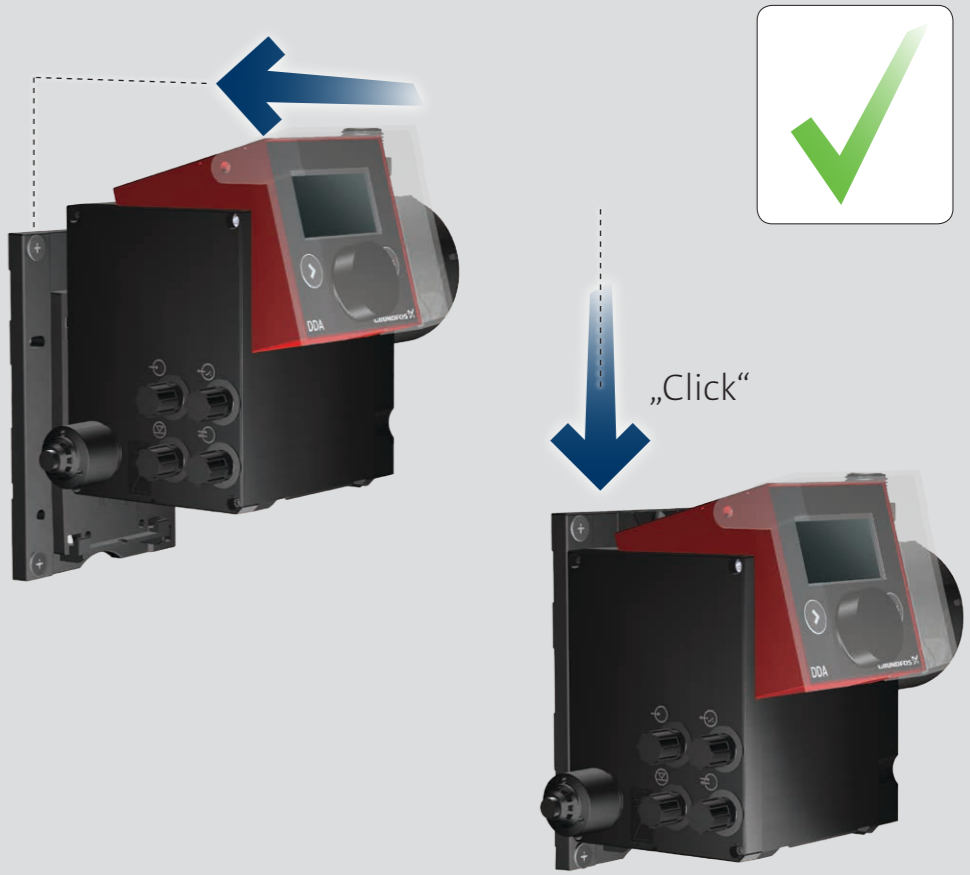



8

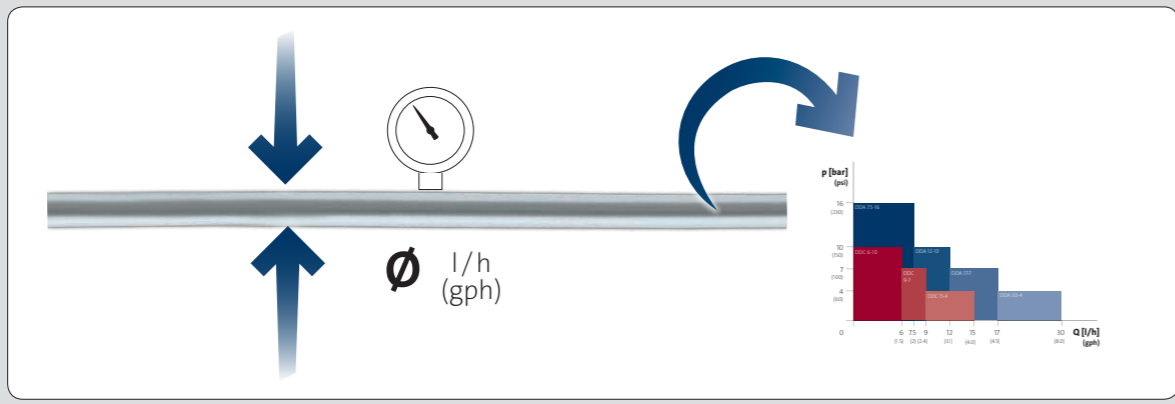
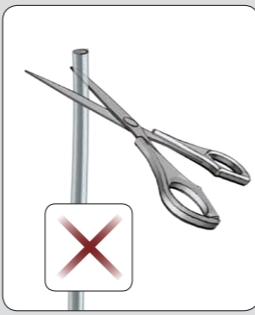

9

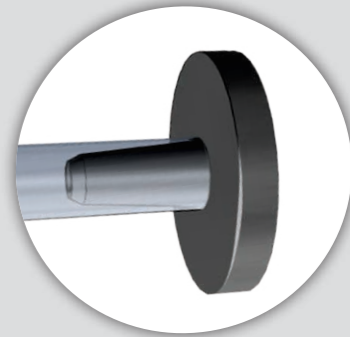
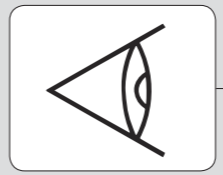

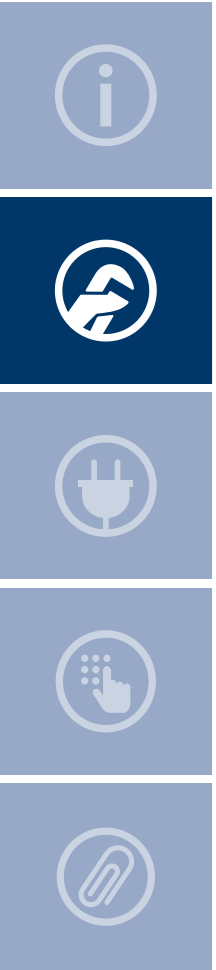

10

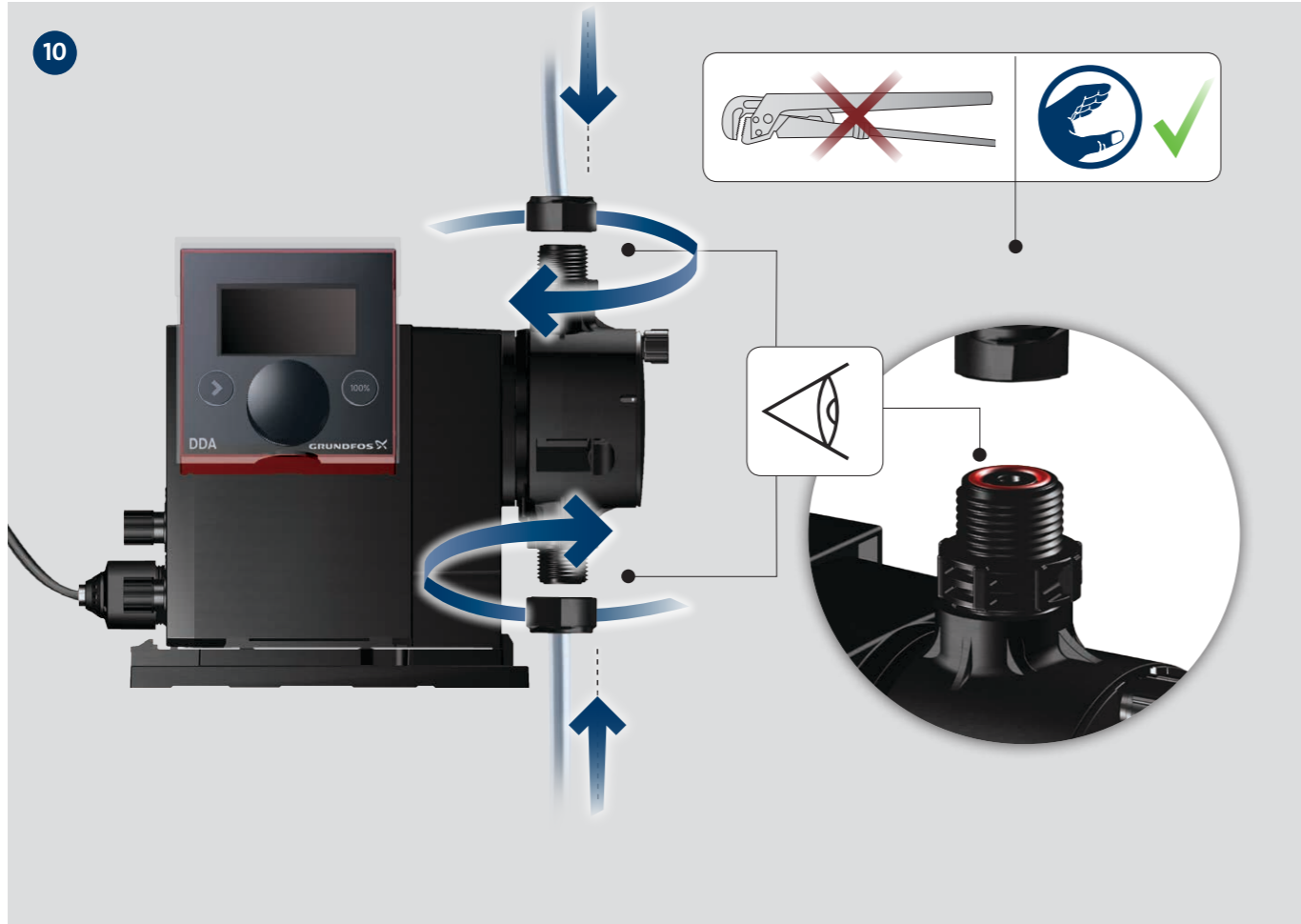

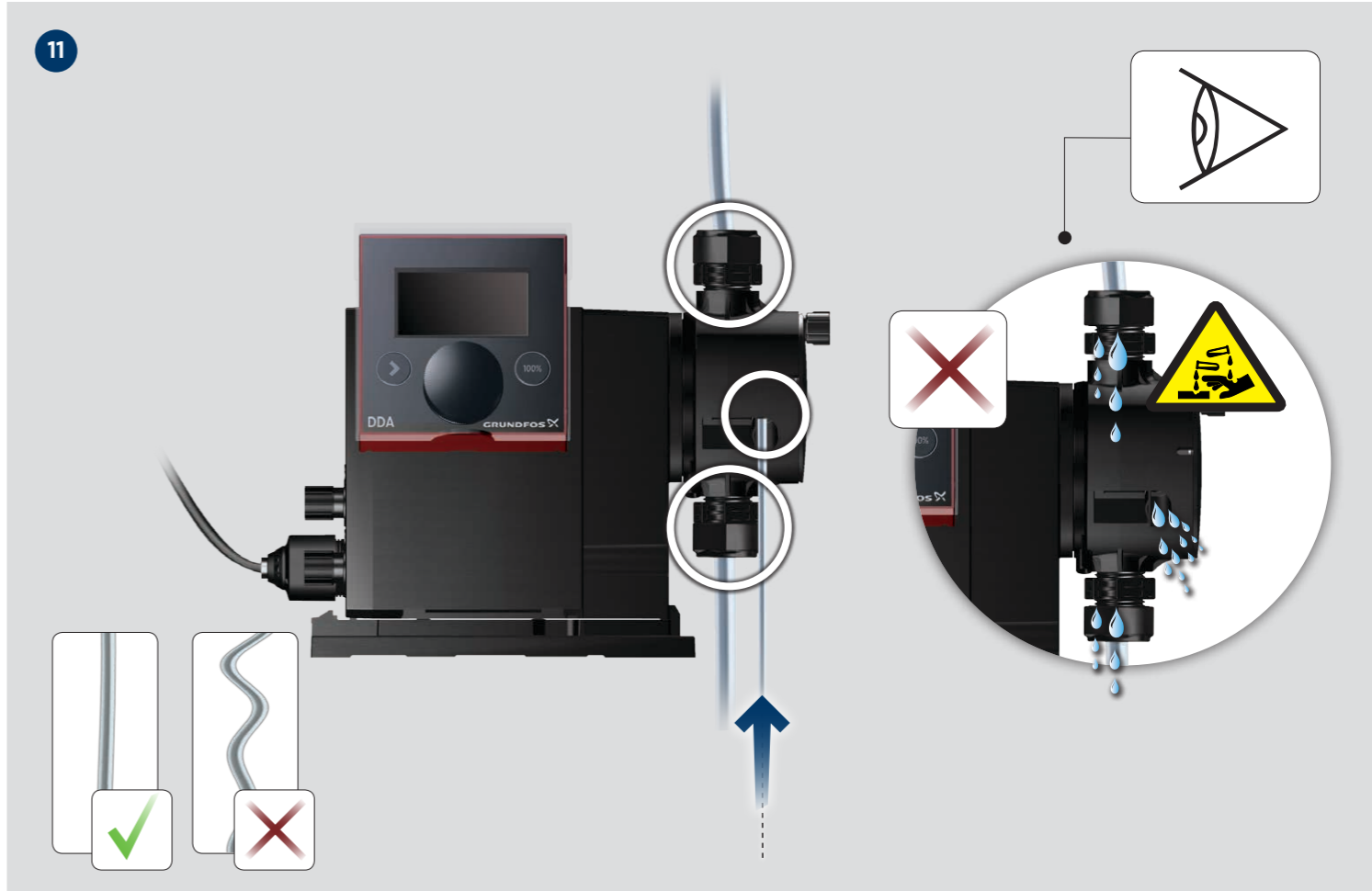

11





12

100 - 240V,
50/60Hz









1 2* 3 4
GND

* ≠ DDC-A



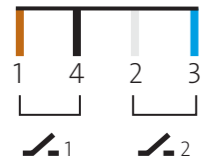



1 4 2 3
≠ DDC-A

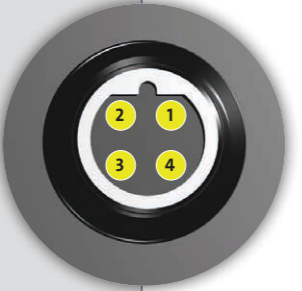



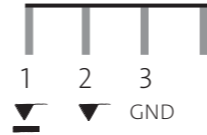



1 2 3
GND

≠ DDC-A





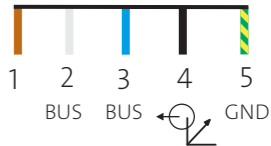

1 2 3 4 5
BUS BUS GND
≠ DDC

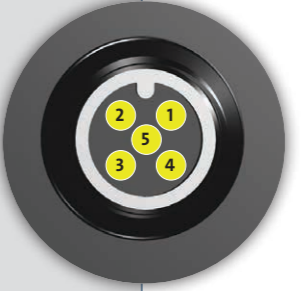



13

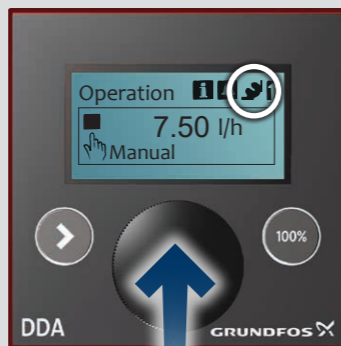
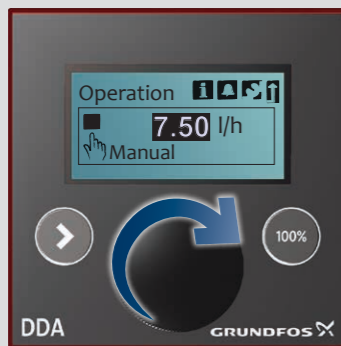

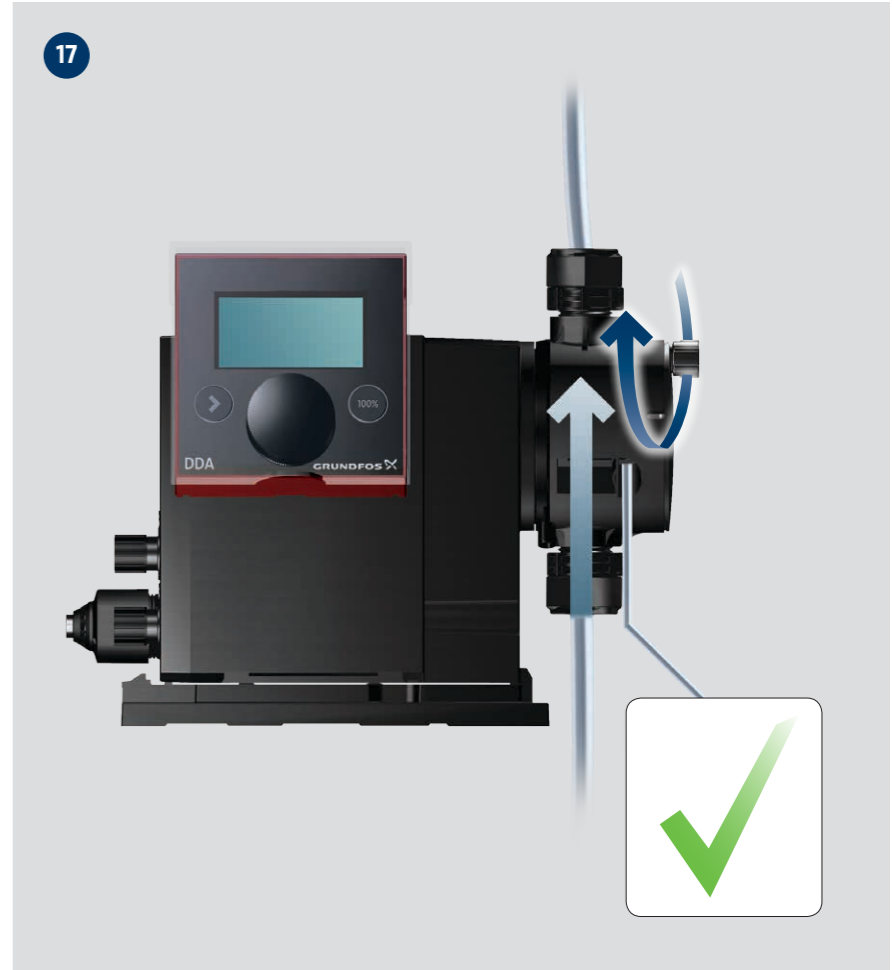
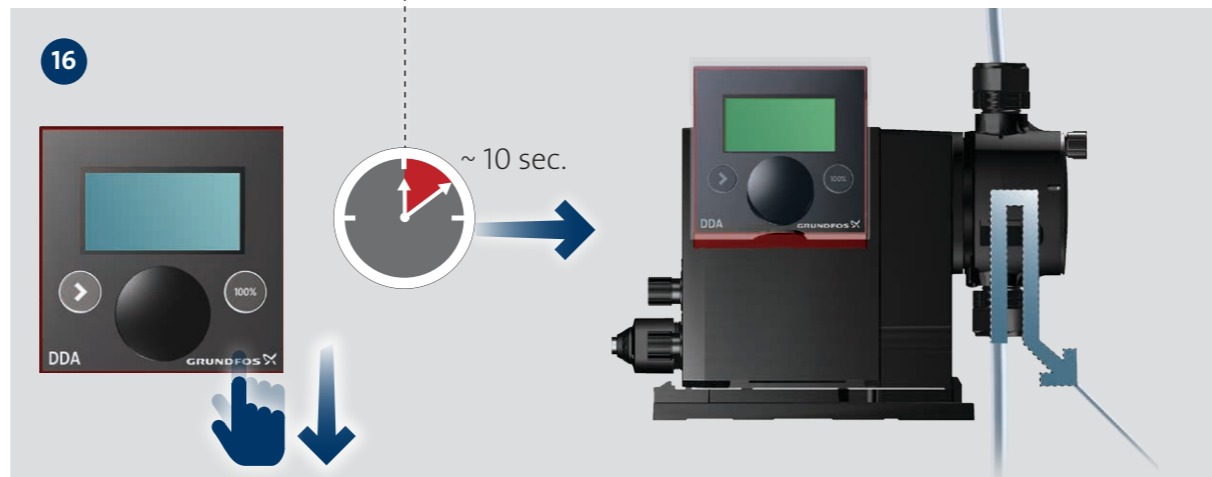
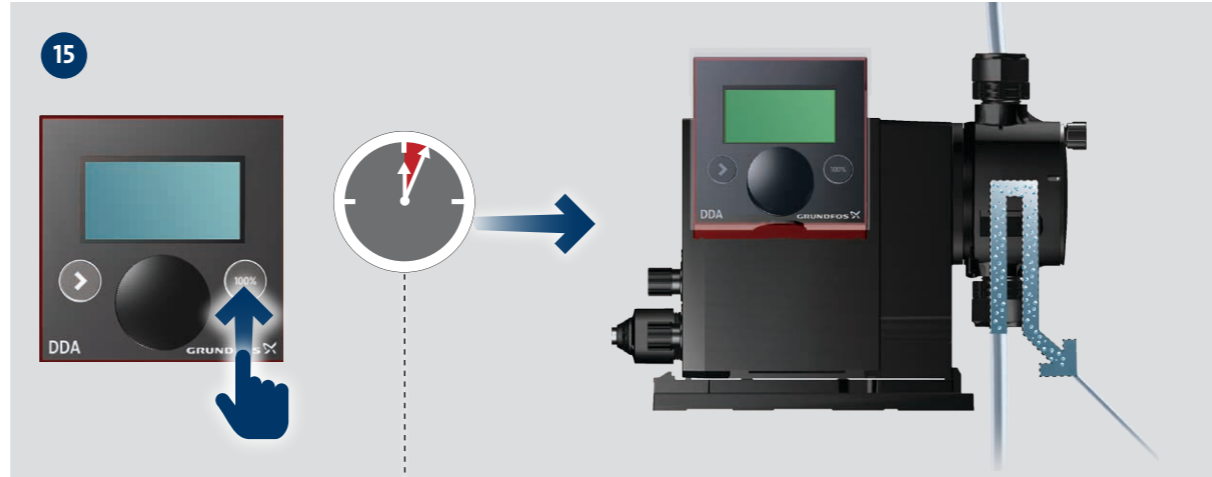
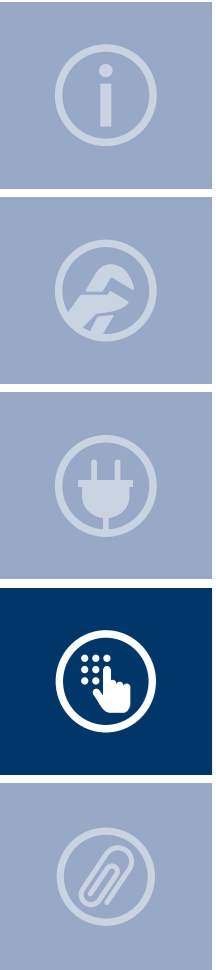



18



V1 - V2
e.g. 300 - 190 ml = 110 ml

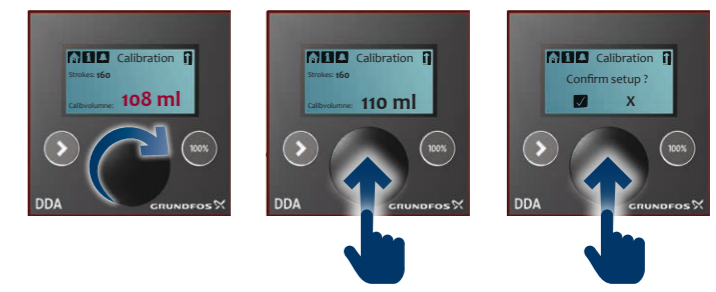

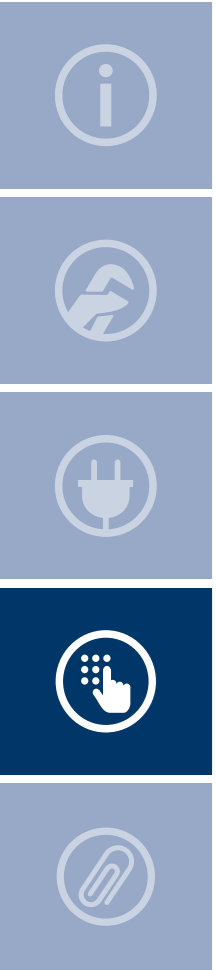

19

Ok



Ok



Warning

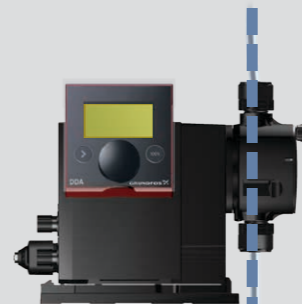

Alarm

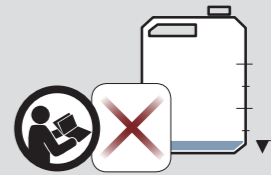

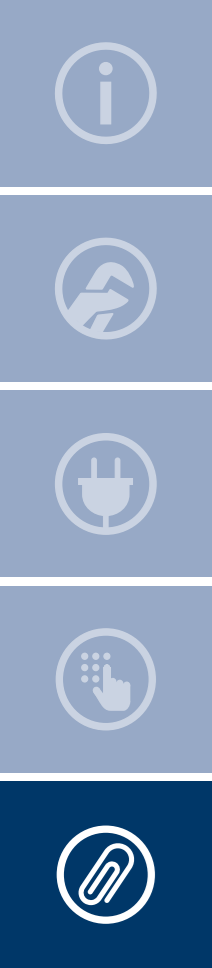

1



2

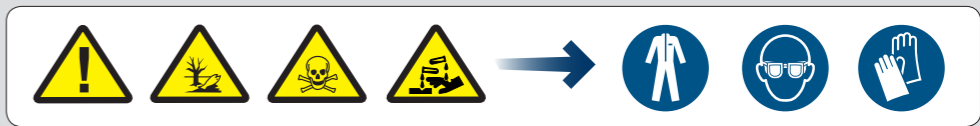

= 0 bar (0 psi)

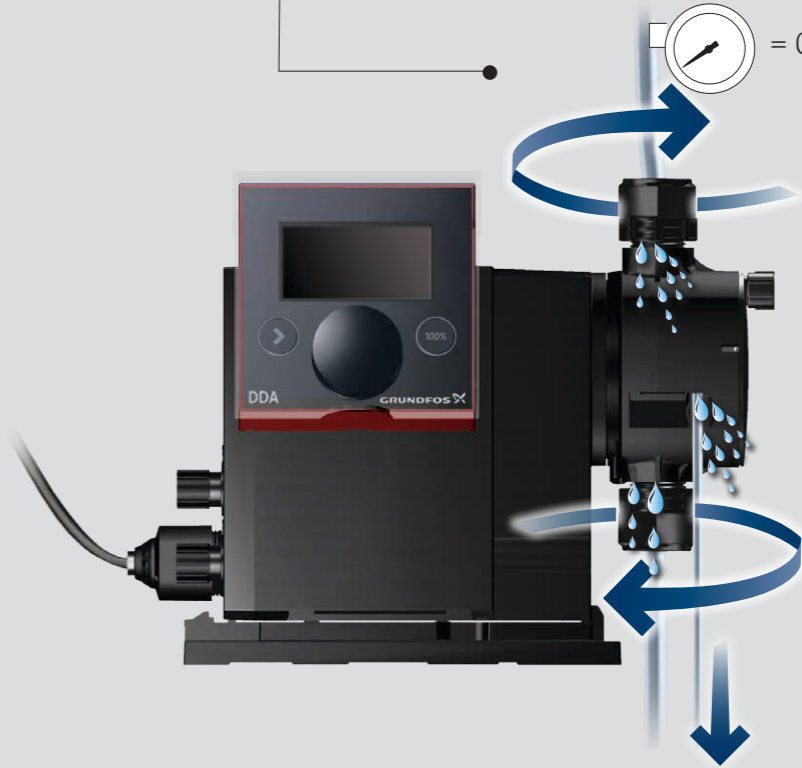

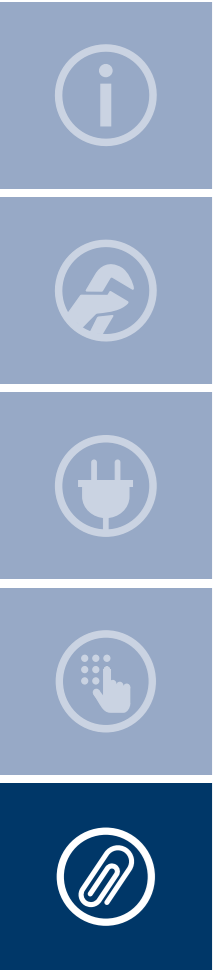

3



4

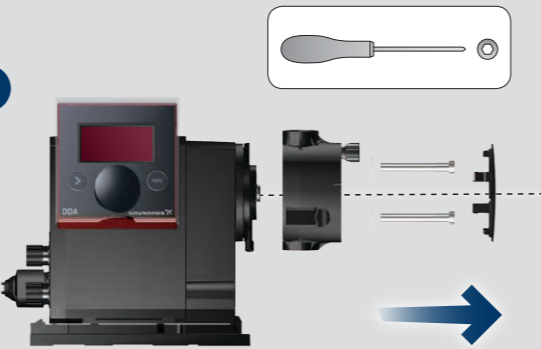

5

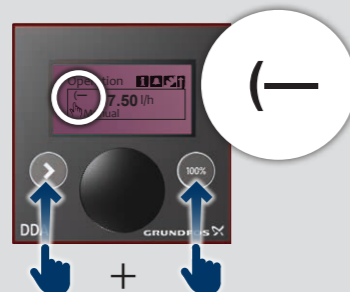

6



7

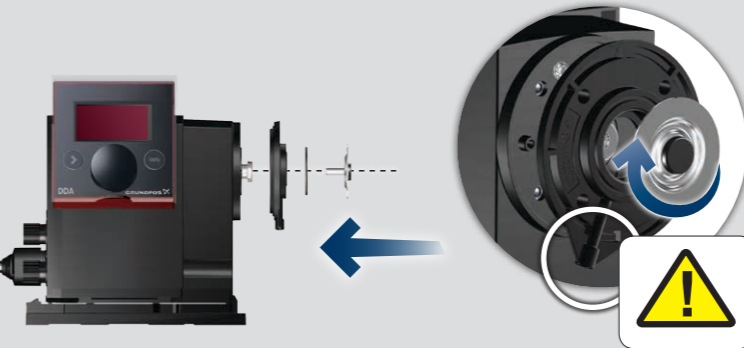

8

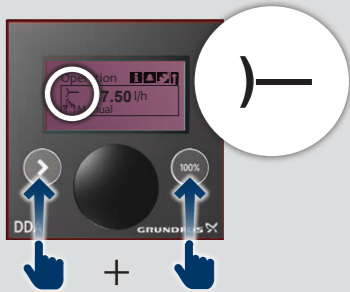

9

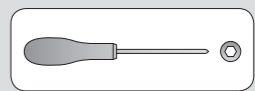

4 Nm (2.95 lb/ft)



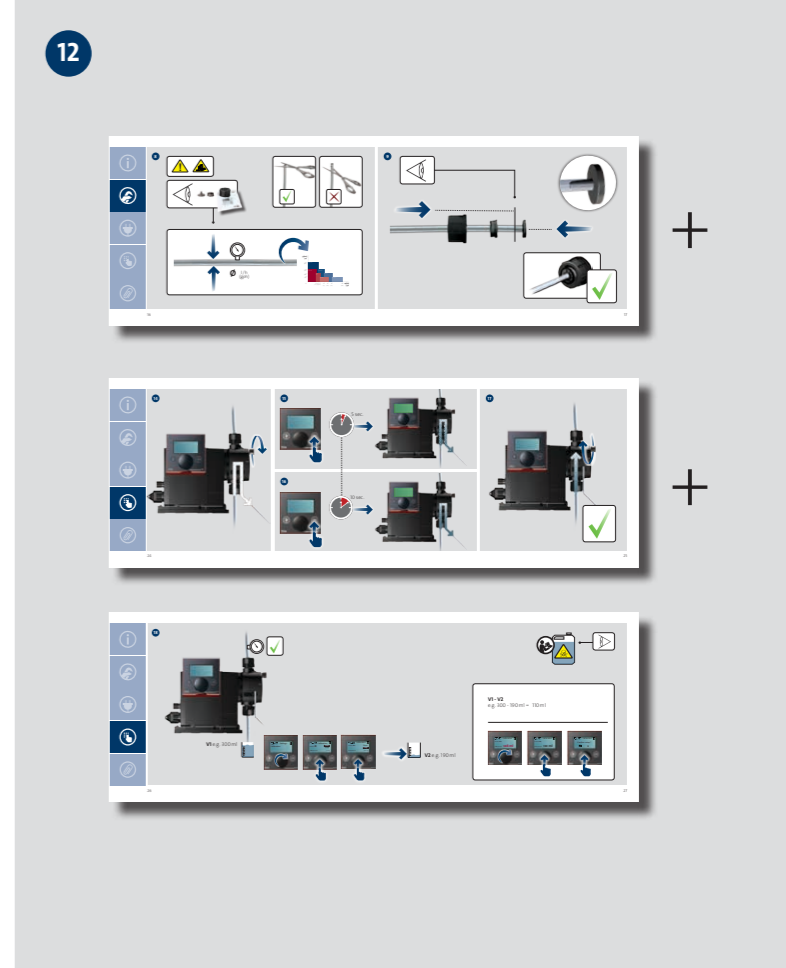
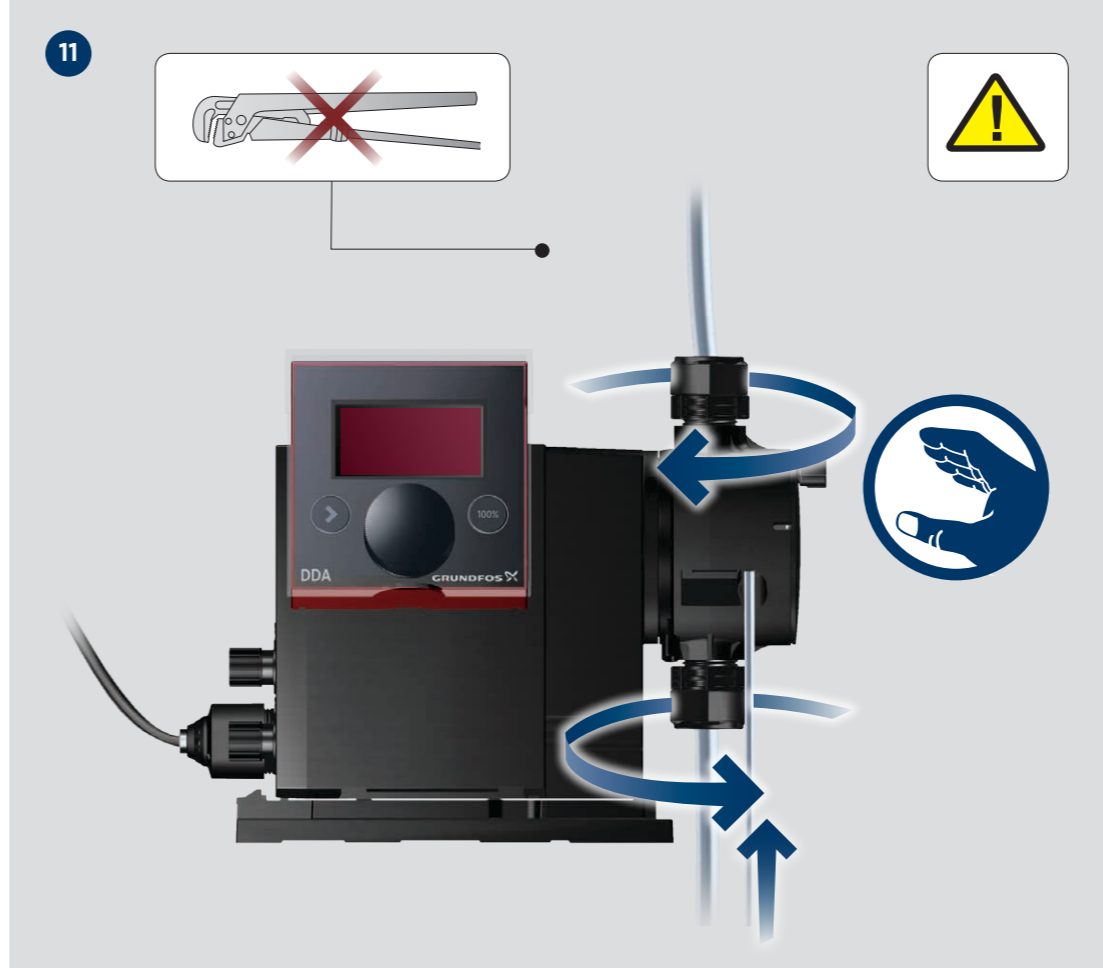
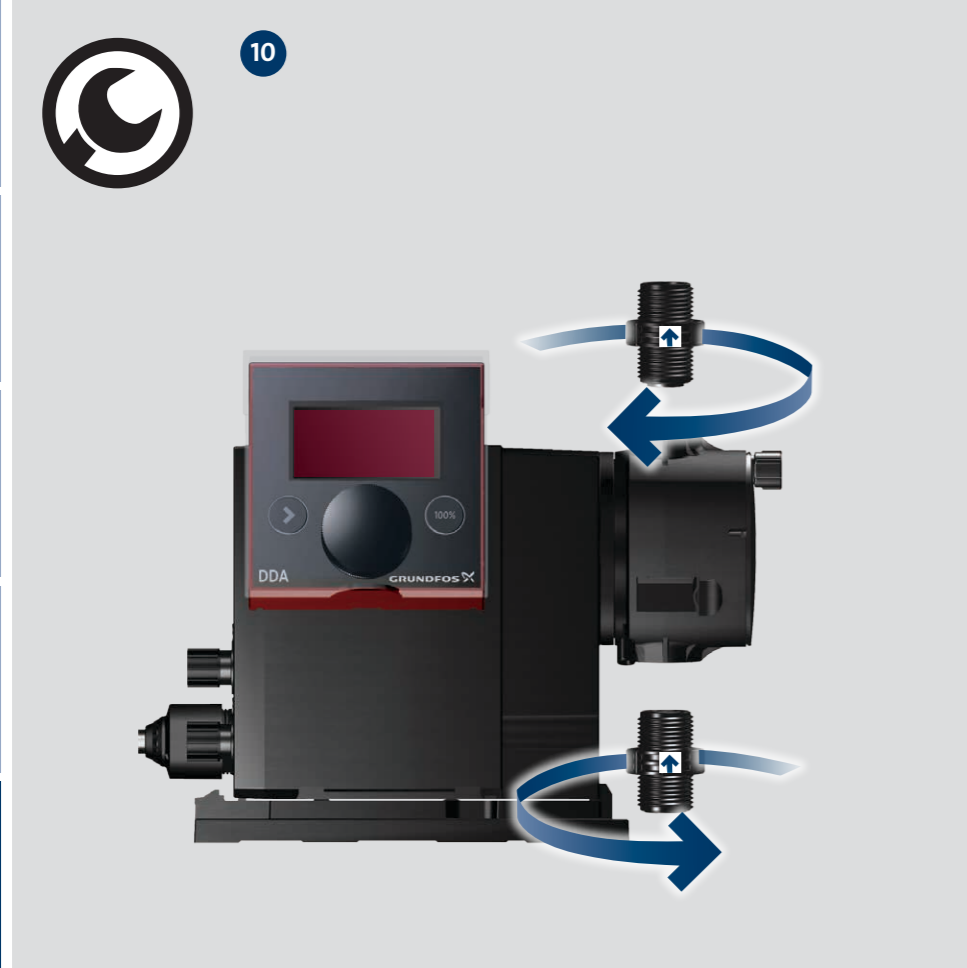
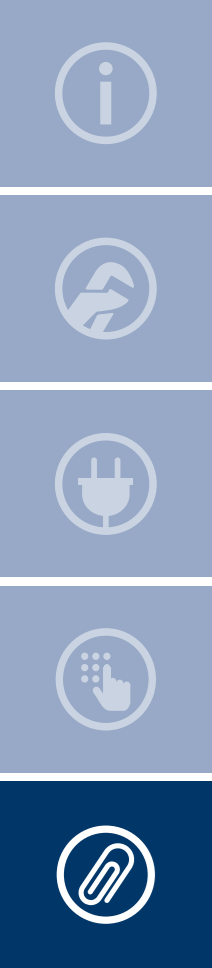

be think innovate

95725552 0617

ECM: 1210890

GRUNDFOS Holding A/S

Poul Due Jensens Vej 7
DK-8850 Bjerringbro
Tel: +45 87 50 14 00
www.grundfos.com

The name Grundfos, the Grundfos logo, and be think innovate are registered trademarks owned by Grundfos Holding A/S or Grundfos A/S, Denmark. All rights reserved worldwide.

GRUNDFOS 

Pumpland.ru