



SMART Digital XL

DDE

60 - 200 l/h
(15.8 - 52.8 gph)

Installation and
operating instructions DDE



net.grundfos.com/qr/i/98767824

be
think
innovate

GRUNDFOS 

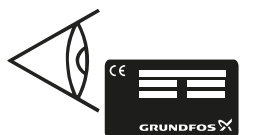

PVC:
0 °C / +45 °C (32 °F / 113 °F)

PVDF/SS:
0 °C / +50 °C (32 °F / 122 °F)

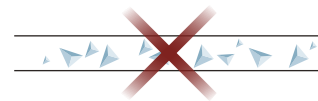

Min./Max.
0 °C / +45 °C
32 °F / 113 °F

≤ 80 dB(A)

IP 65 (Nema 4x)



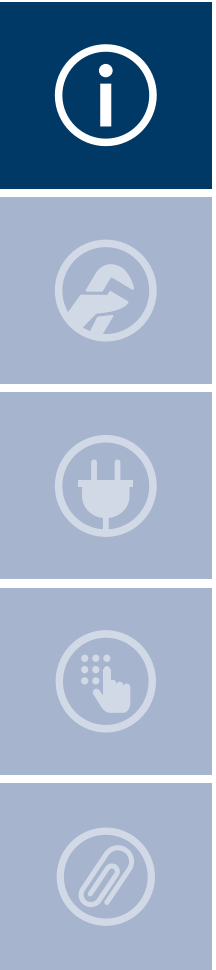

i

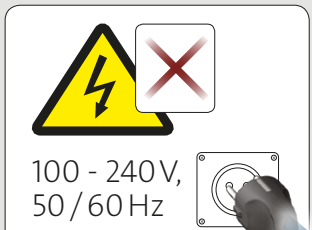
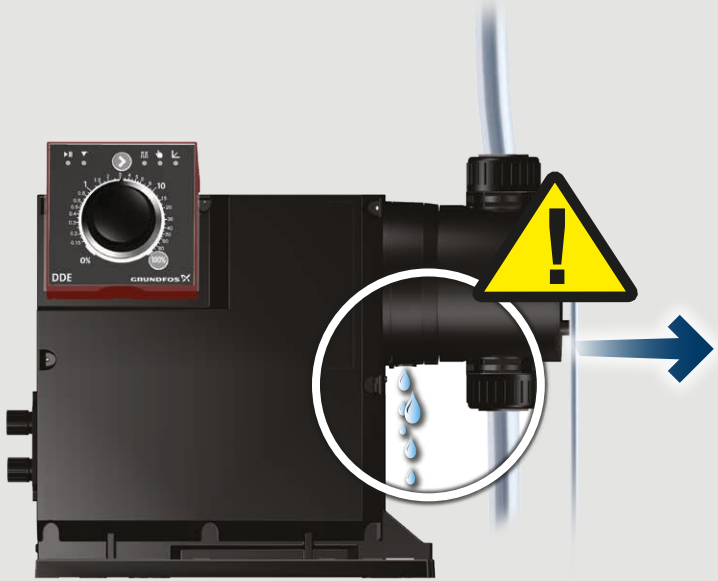
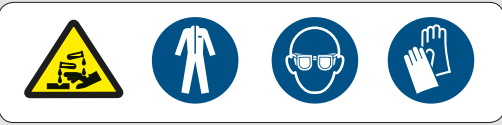

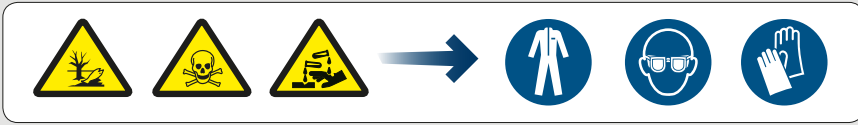

i

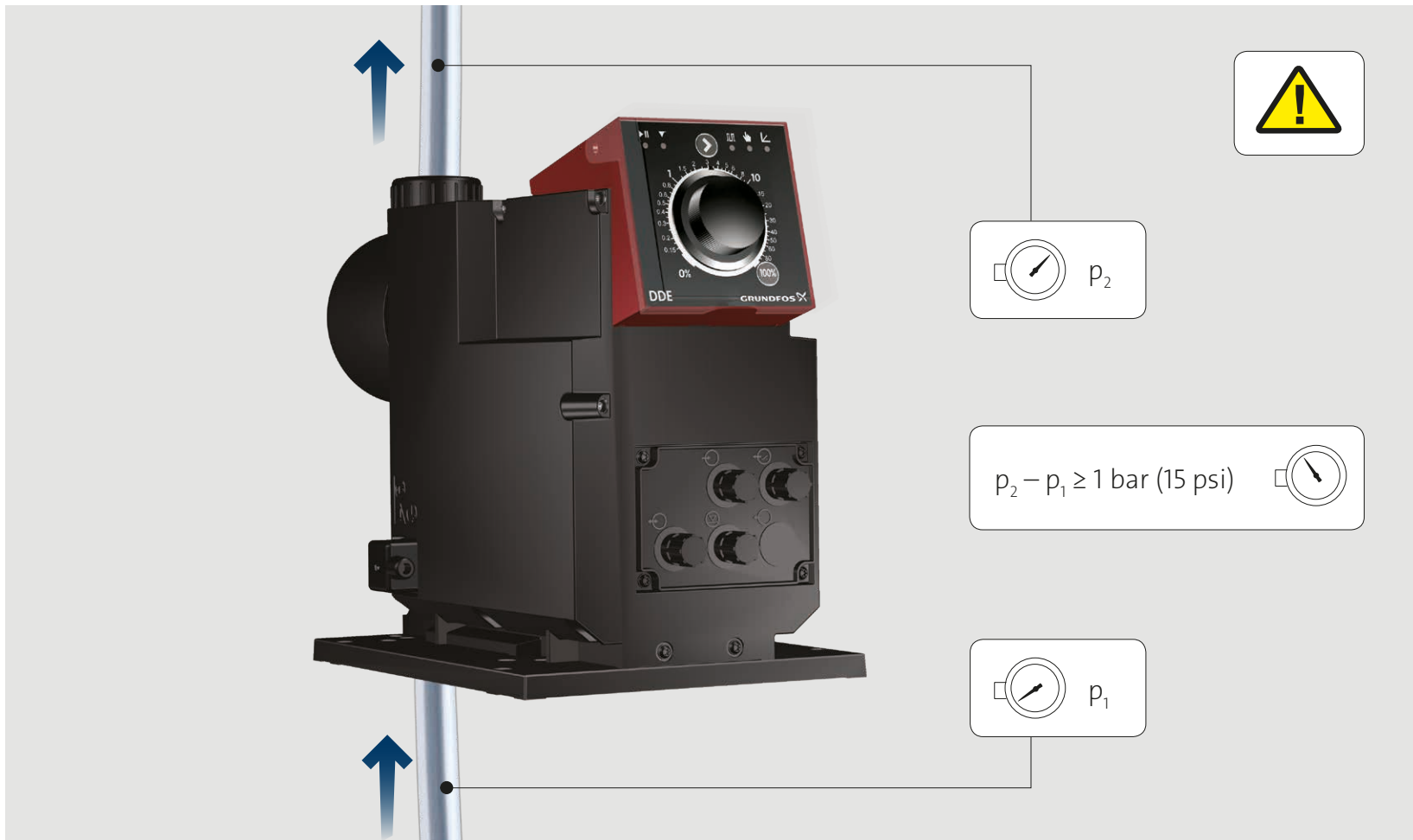
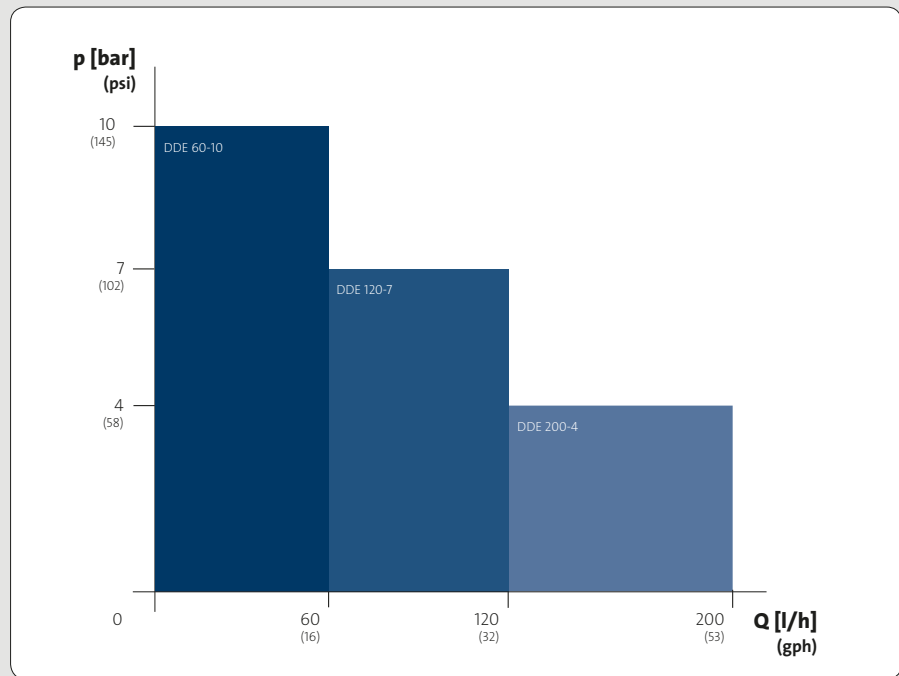
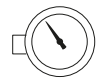

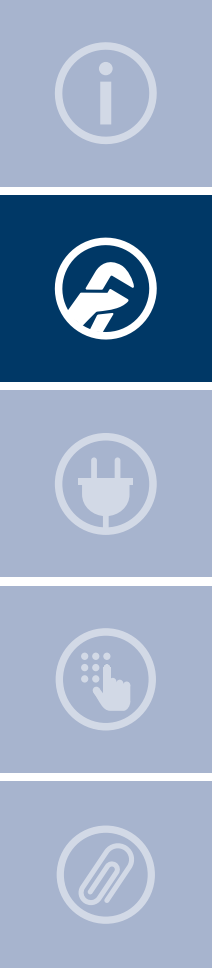



 100 - 240V,
50/60 Hz 

≤ 1.5 m/59"

≥ 100 mm/4"

≥ 100 mm/4"



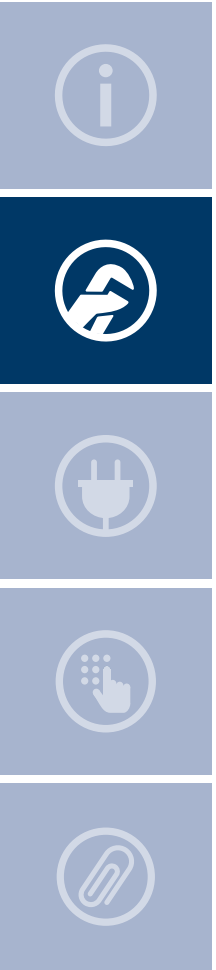

1

TORX PLUS (15 IP)



2

STOP



3

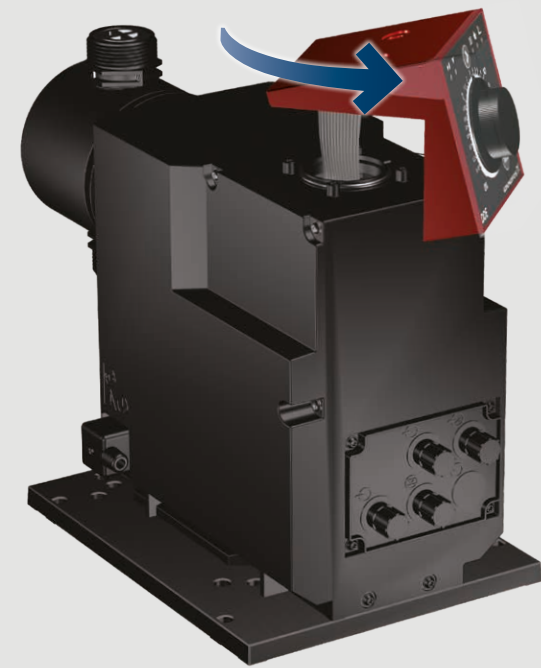

4

TORX PLUS (15 IP)

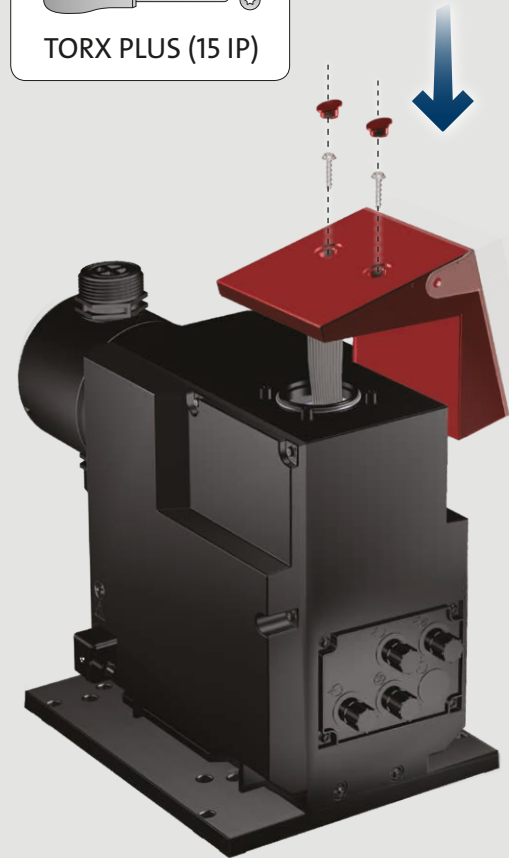

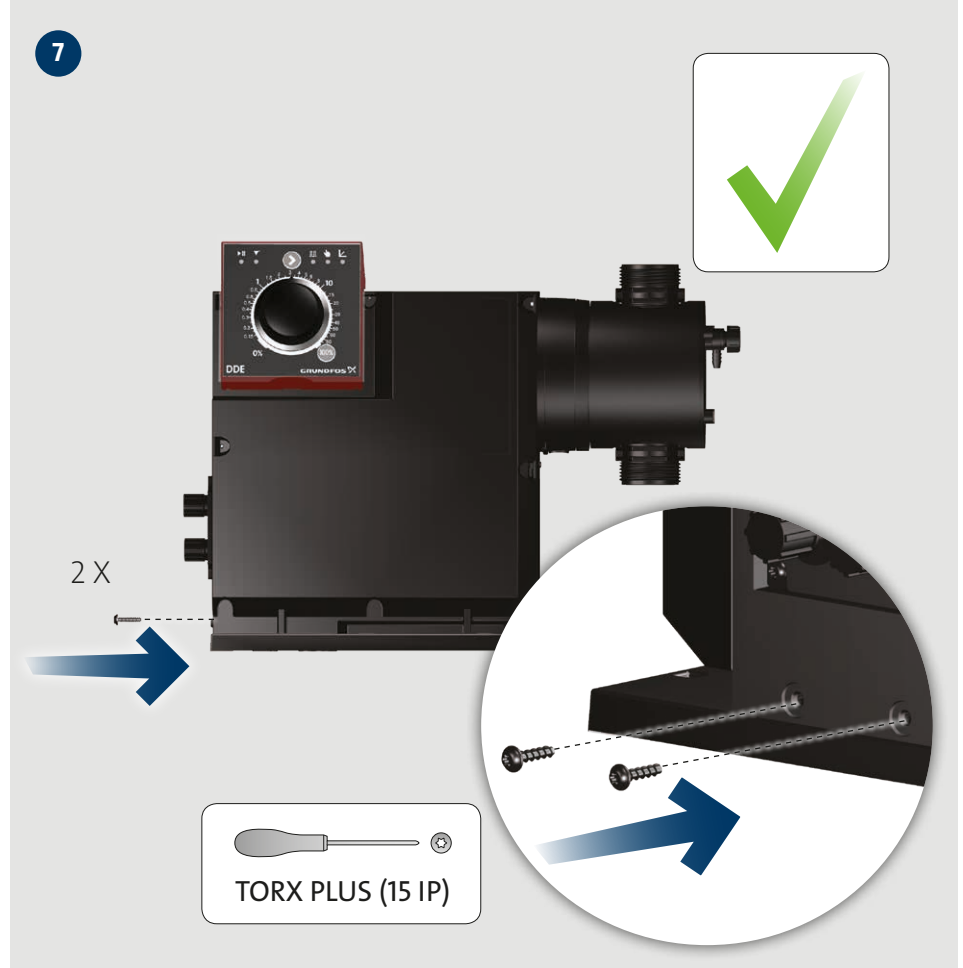
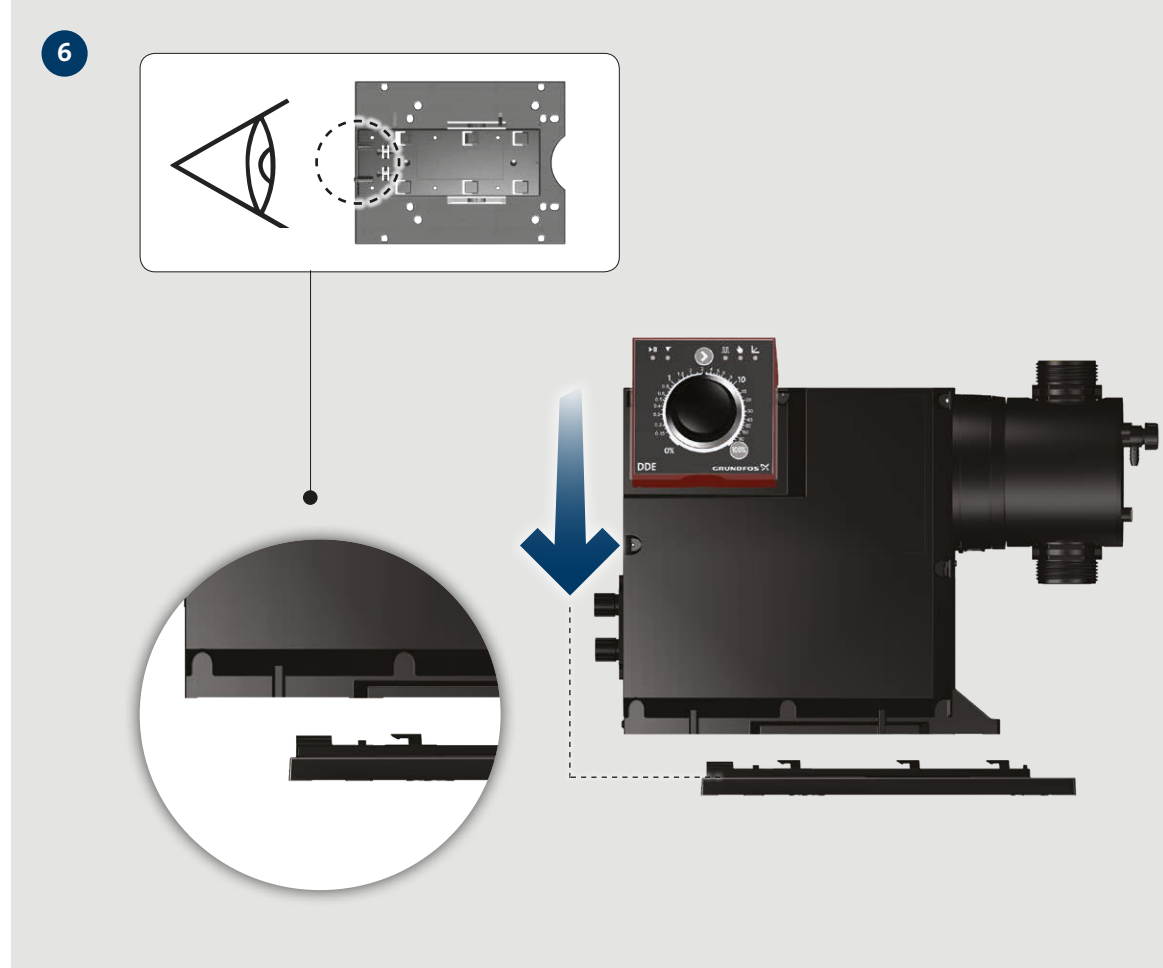
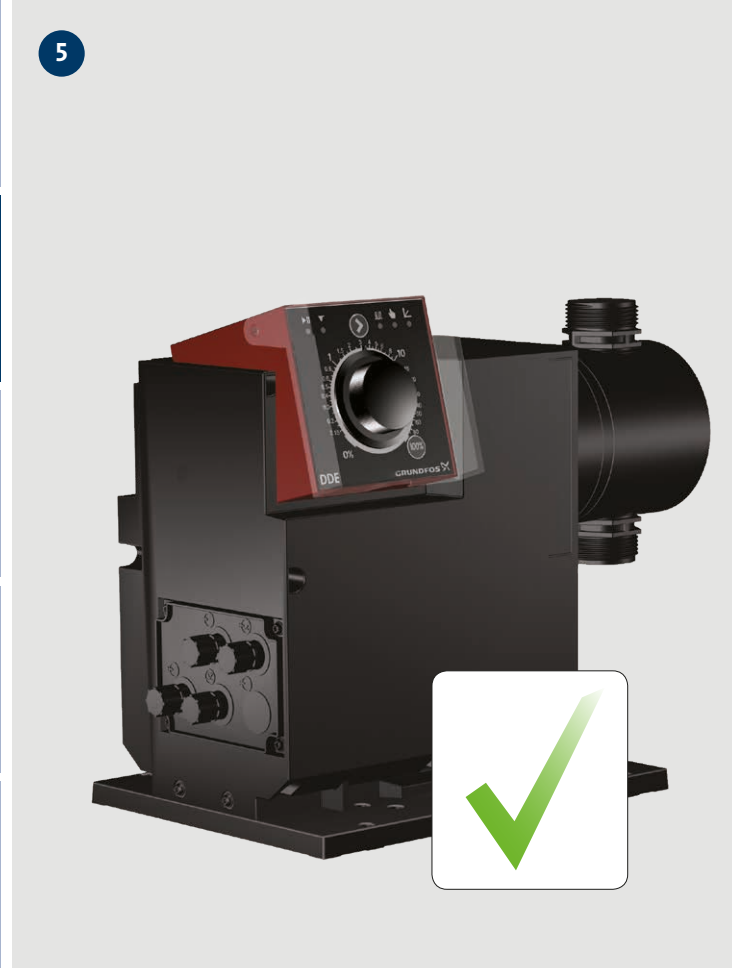
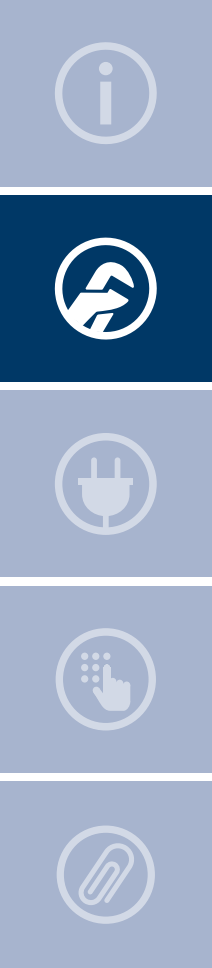

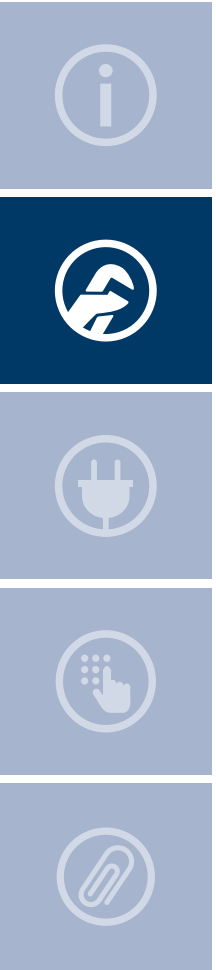

8

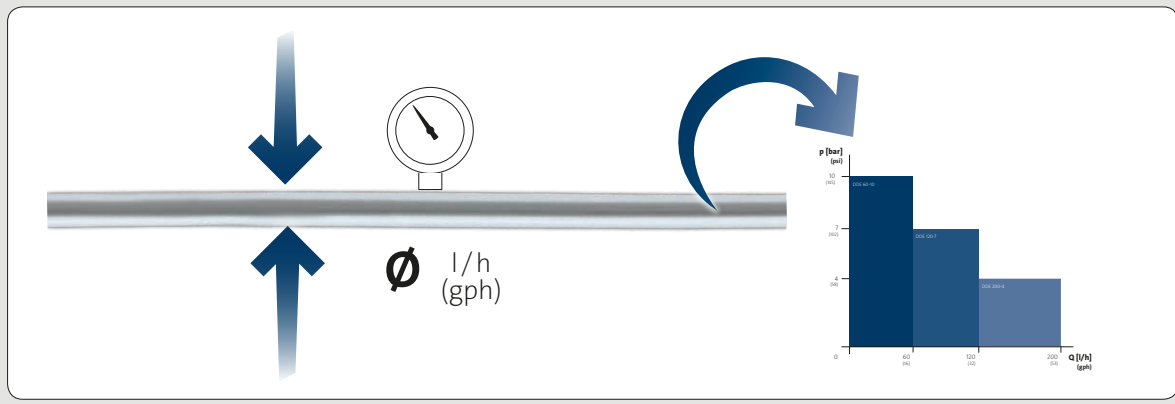
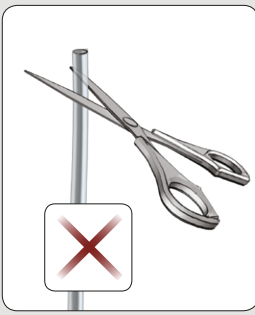
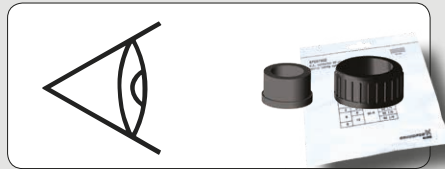

9a

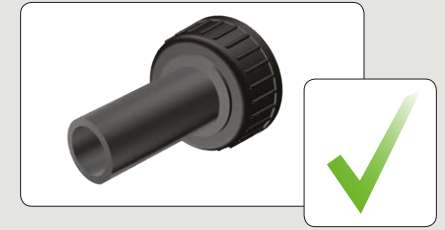
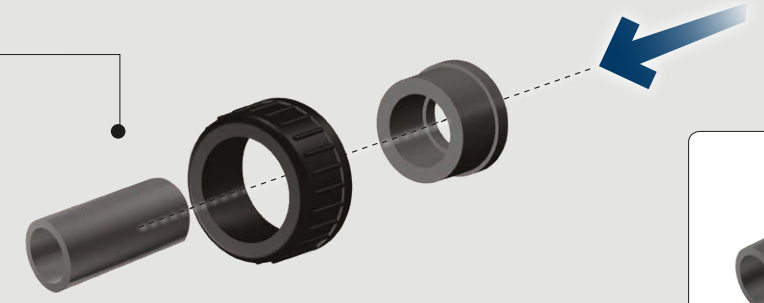
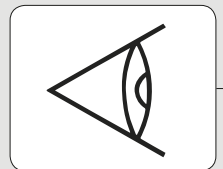

9b

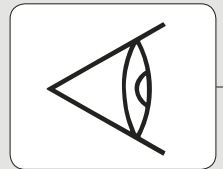

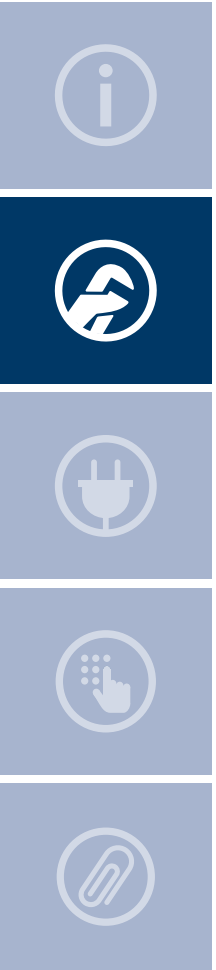

10

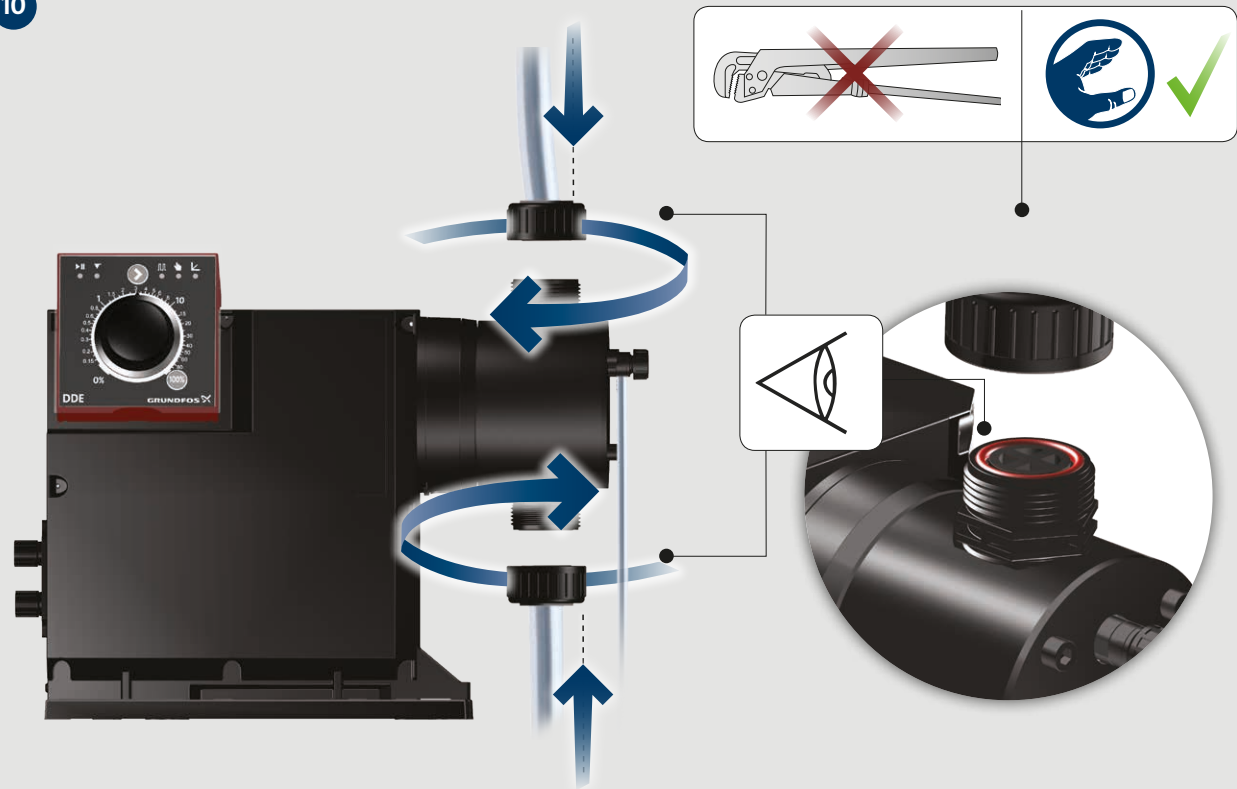

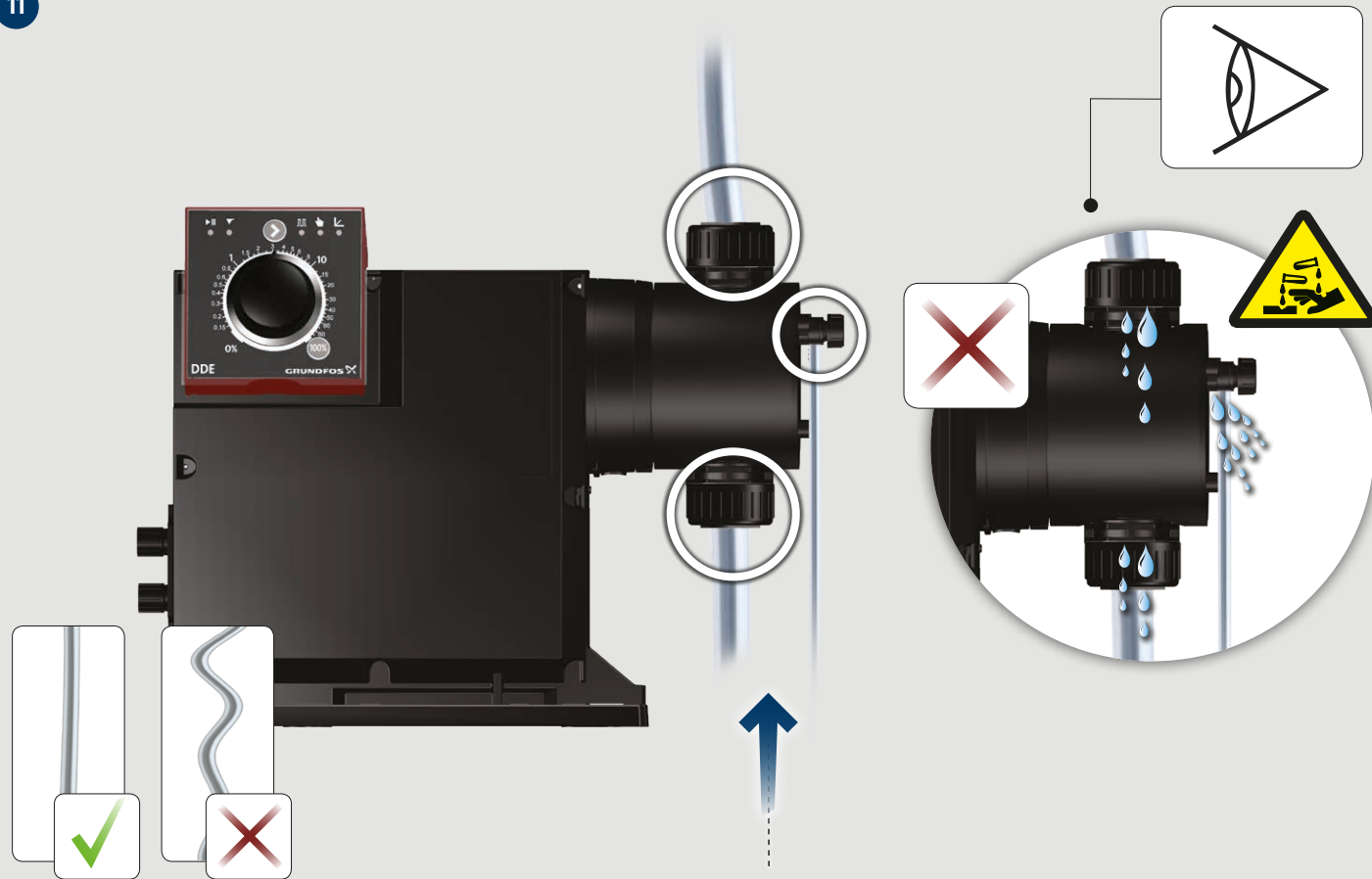

11

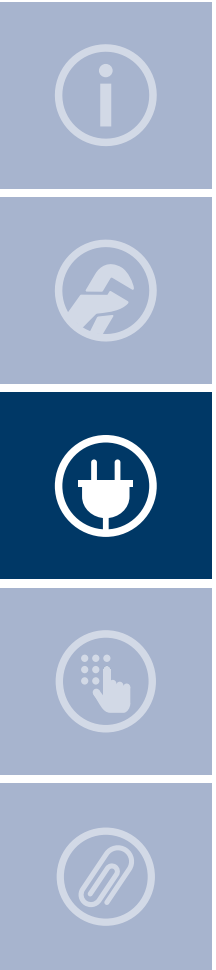



12

100 - 240V,
50/60Hz



Grundfos service 

DDE-AR

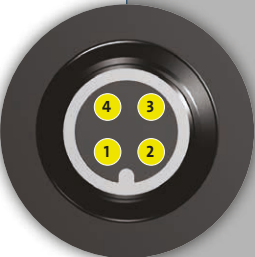
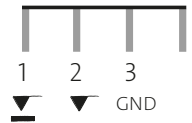
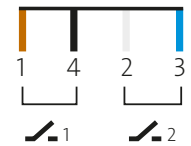
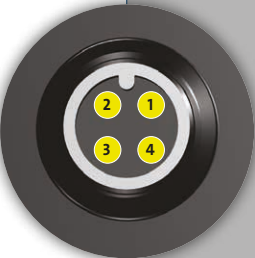
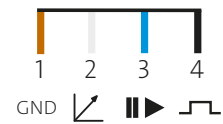



13

DDE-AR



DDE-AR

100%



DDE-AR



≥ 5 sec.



DDE-B

100%



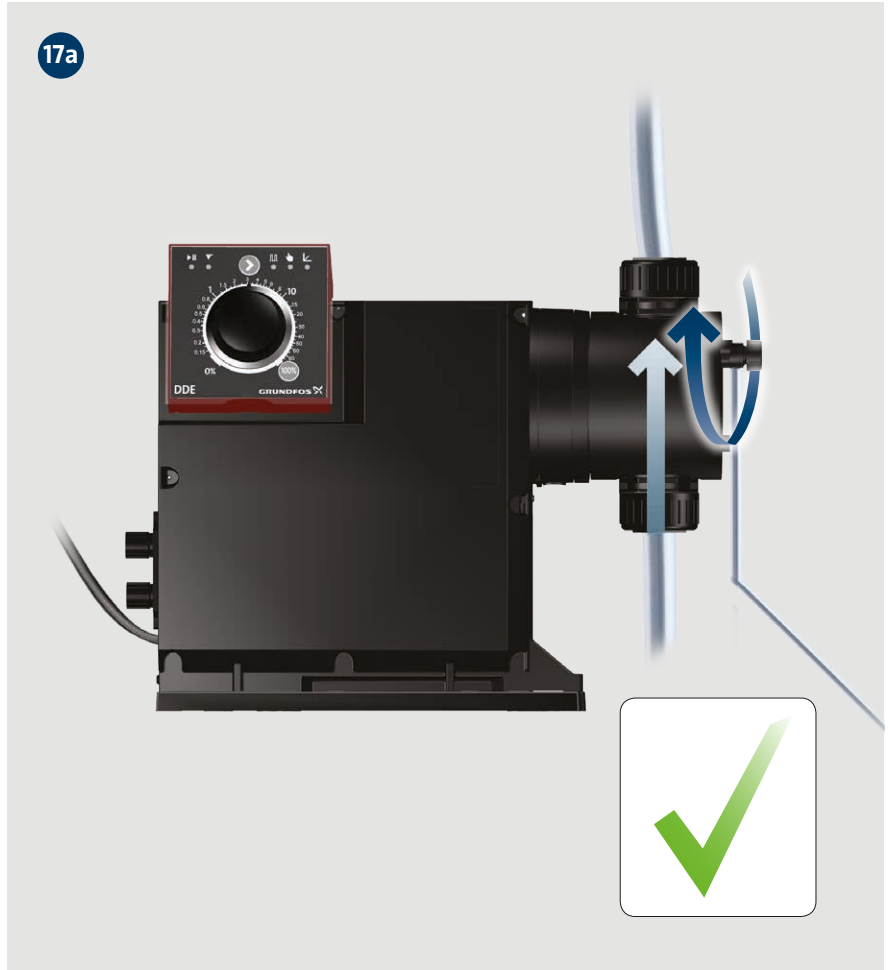
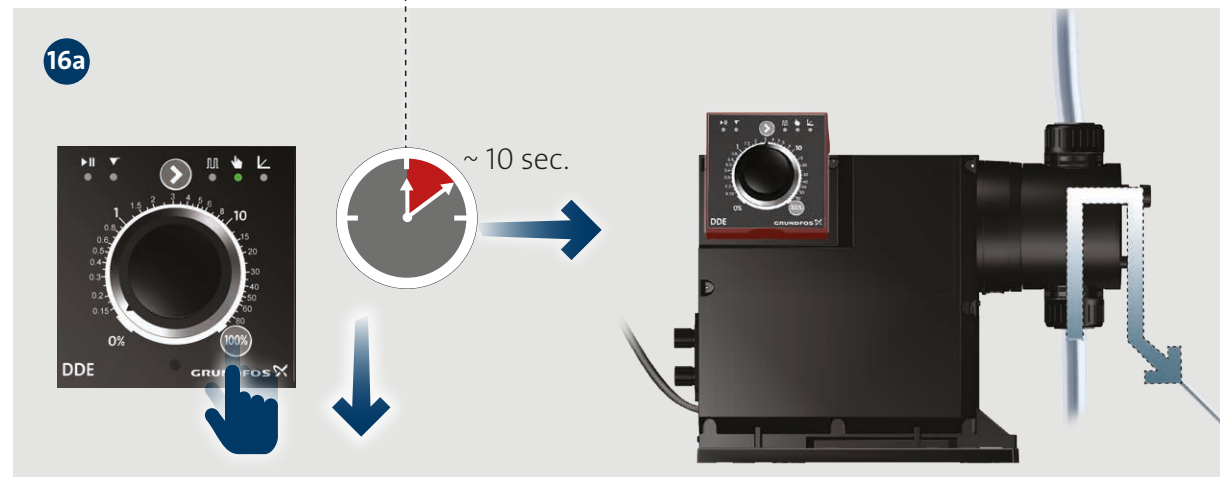
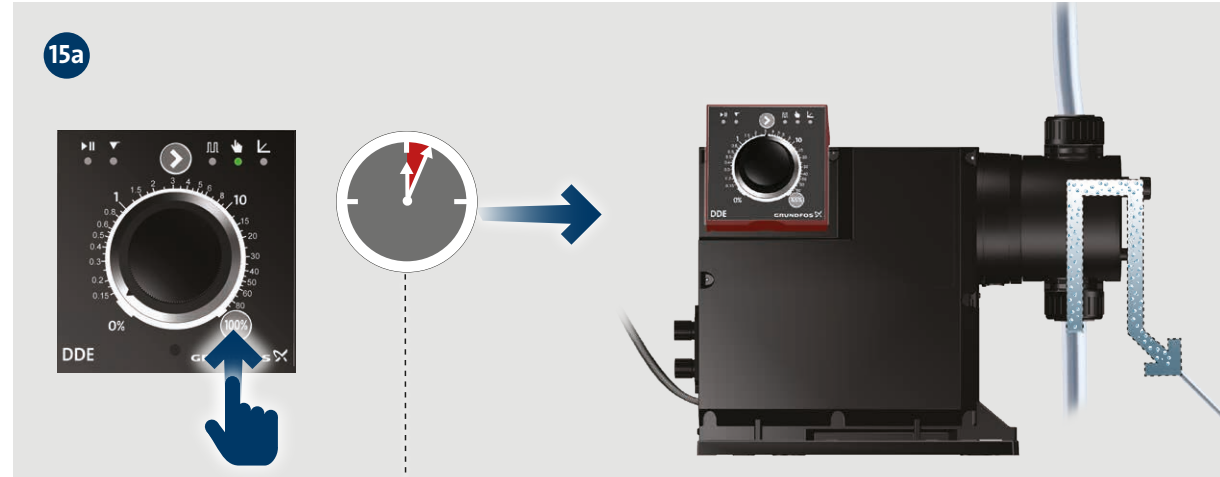
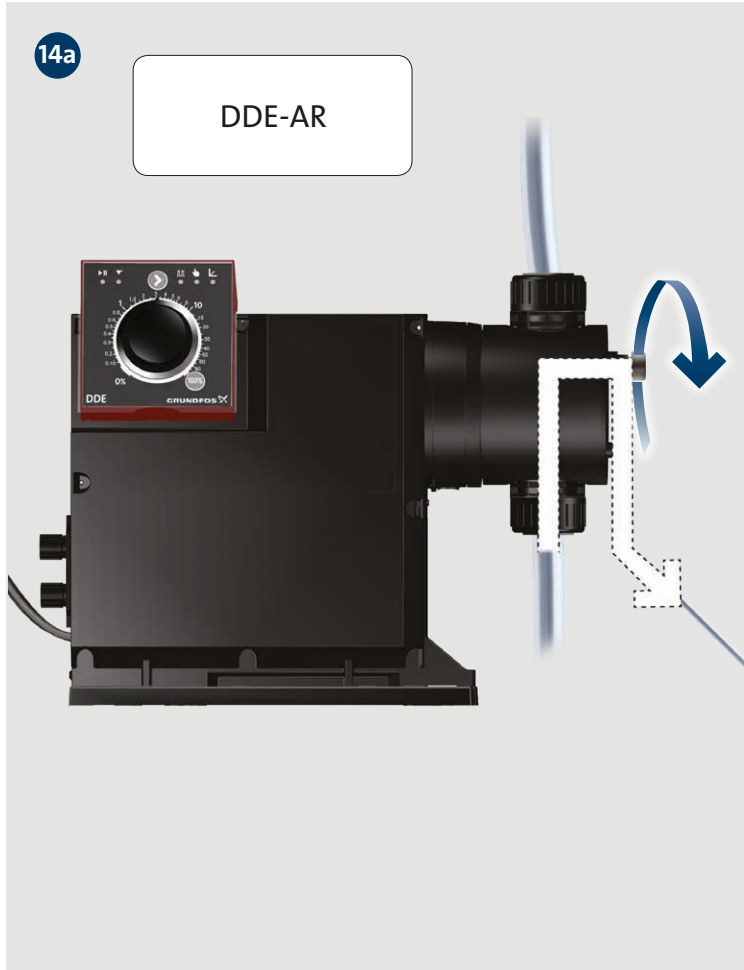
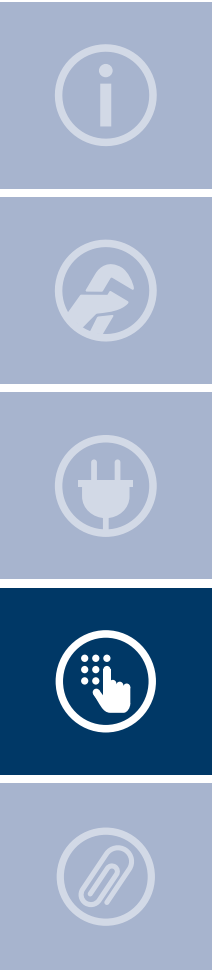

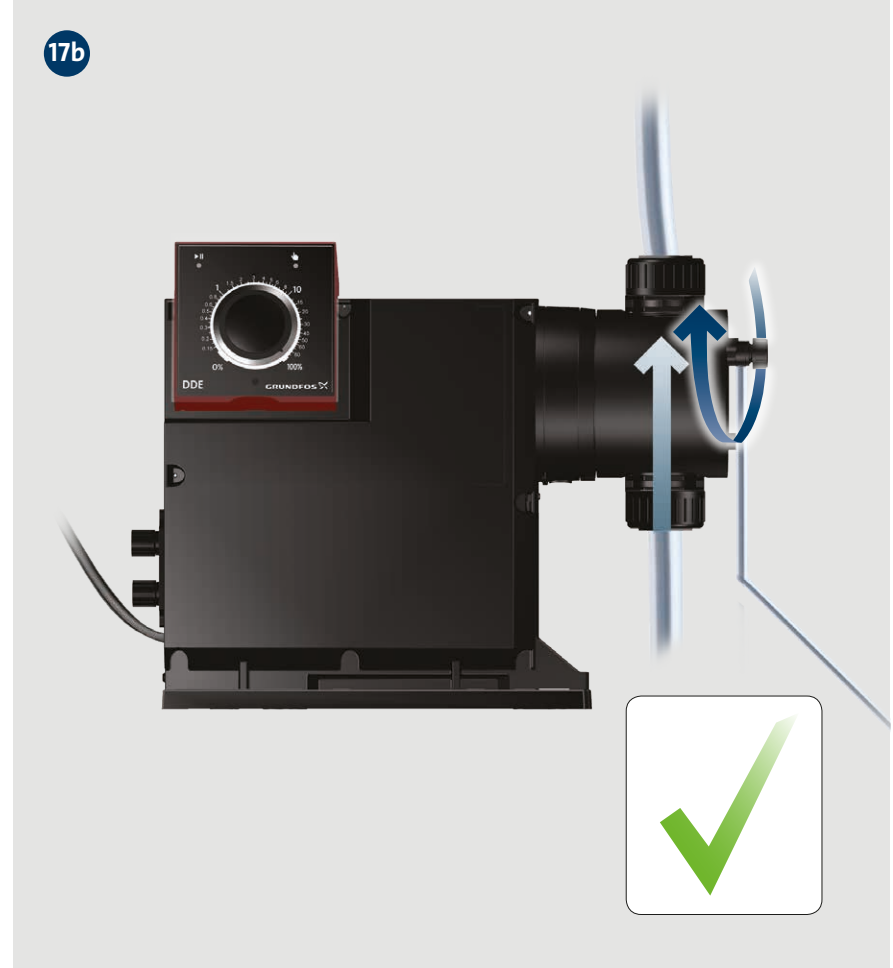
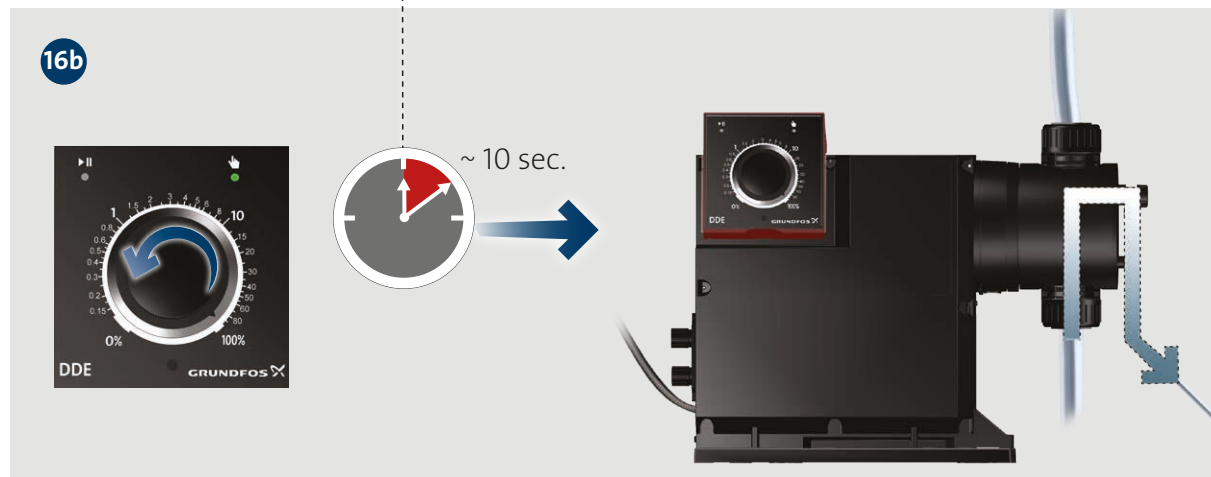
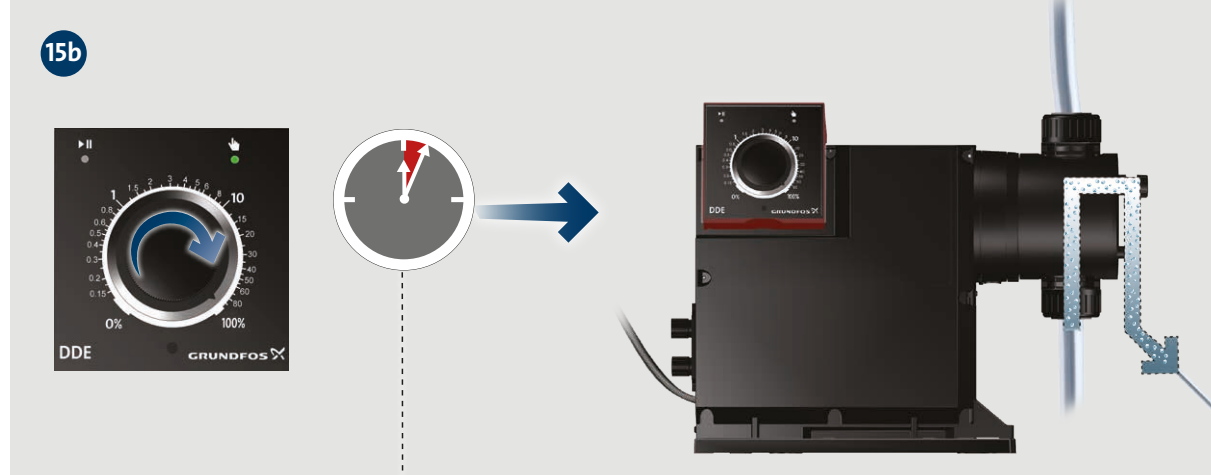
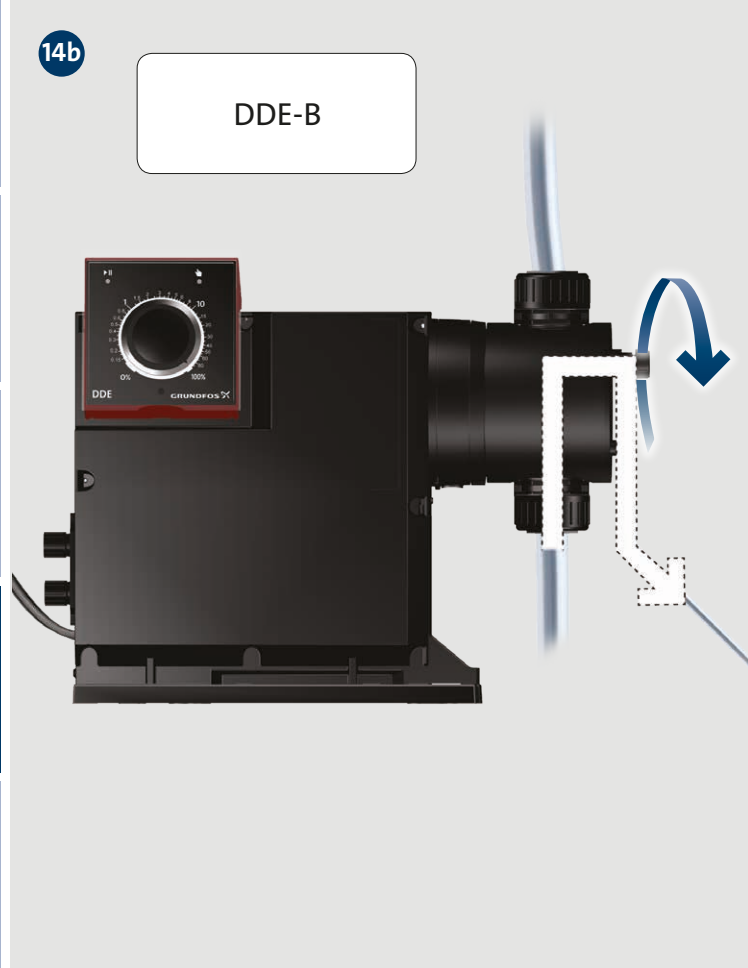
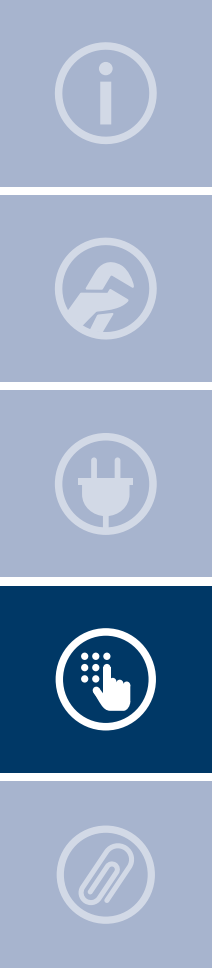

18

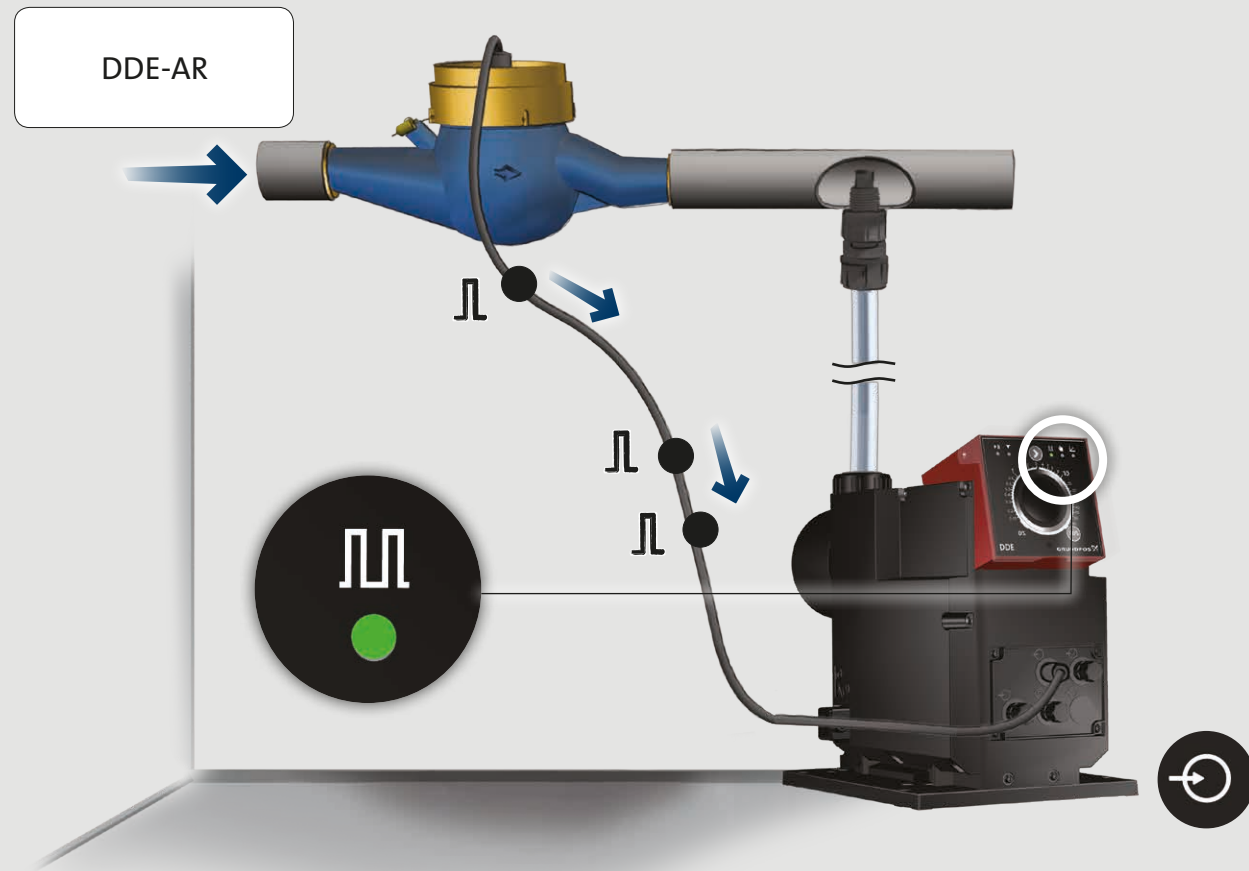
**DDE 60-10**

~ 5.56 ml/л

**DDE 120-7**

~ 11.58 ml/л

**DDE 200-4**

~ 19.30 ml/л

~ 2.78 ml/л

~ 5.79 ml/л

~ 9.65 ml/л

~ 0.56 ml/л

~ 1.16 ml/л

~ 1.93 ml/л



19

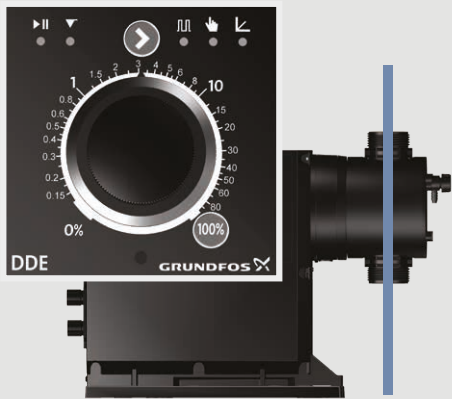
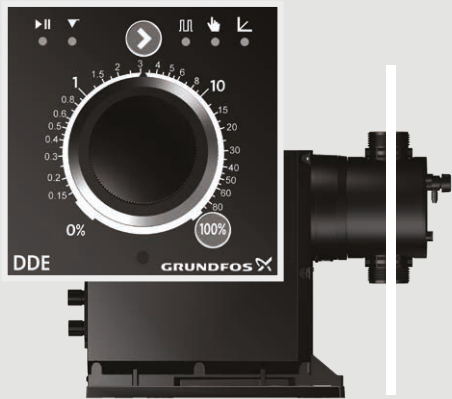

DDE-AR / DDE-B

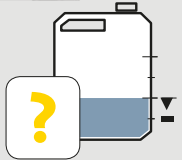

DDE-AR / DDE-B



DDE-AR / DDE-B



e.g.



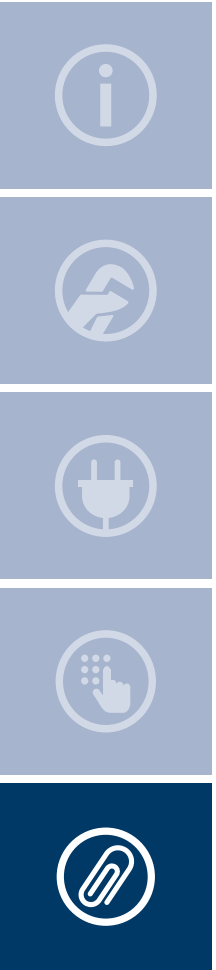

Service kit catalogue
net.grundfos.com/qr/i/96488862_23

1



Installation and operating instructions DDE
net.grundfos.com/qr/i/98767824



2

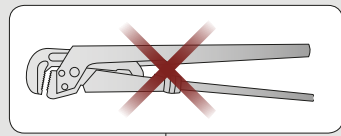

= 0 bar (0 psi)

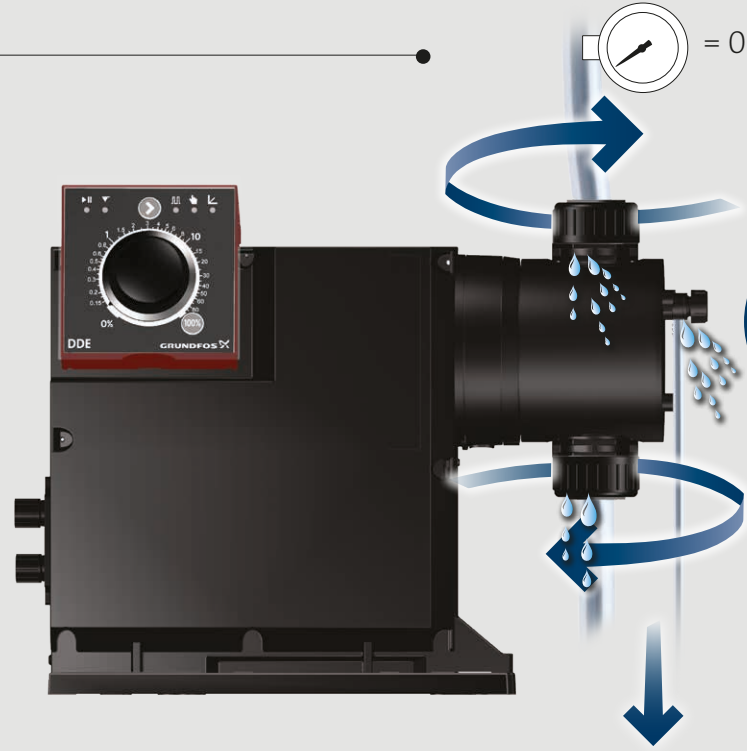

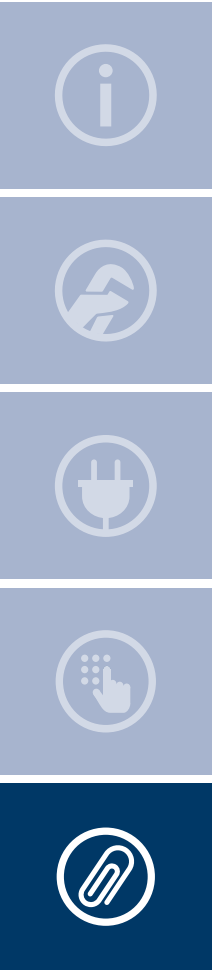

 DDE 60-10

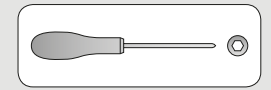
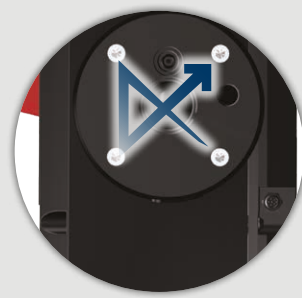
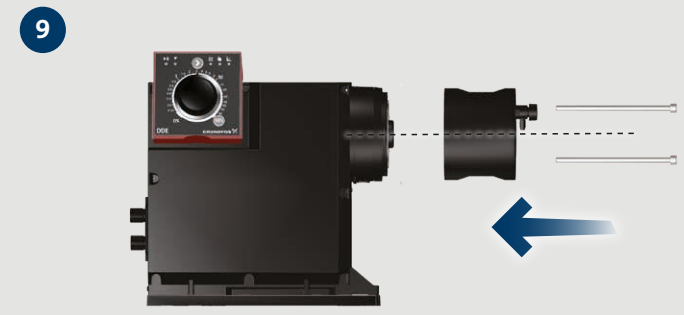
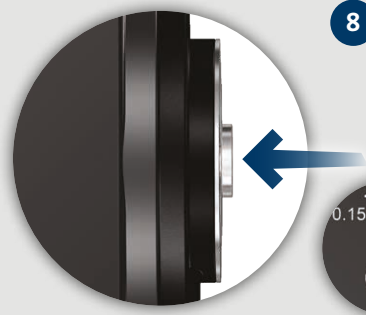
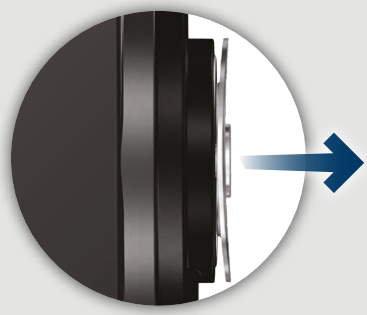
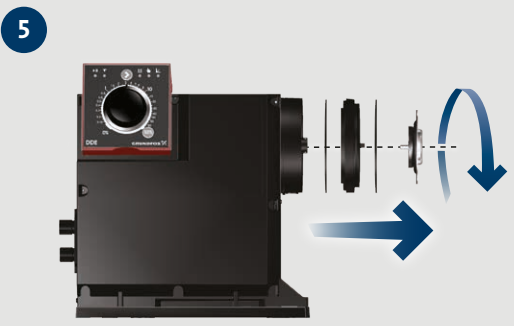

6 (+1) Nm
(4.4 (+0.7) lb/ft)

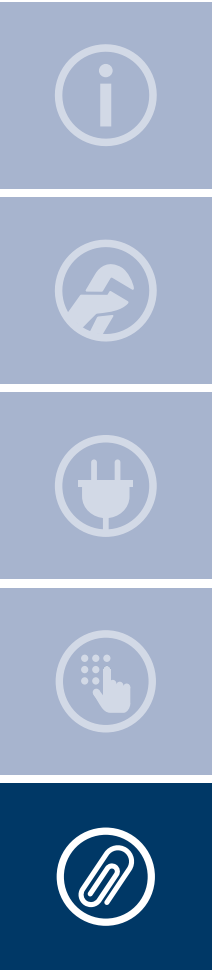

DDE 120-7 / DDE 200-4

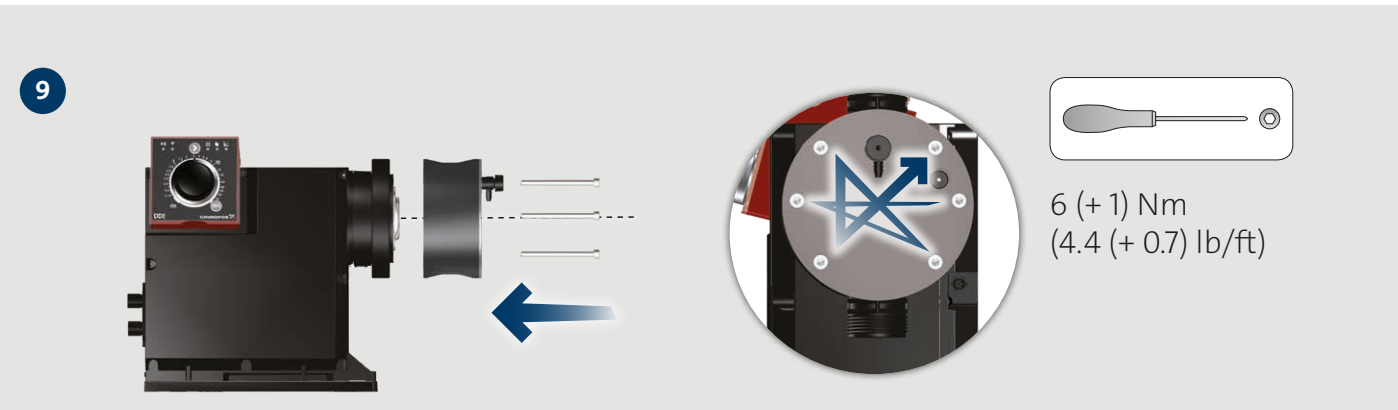
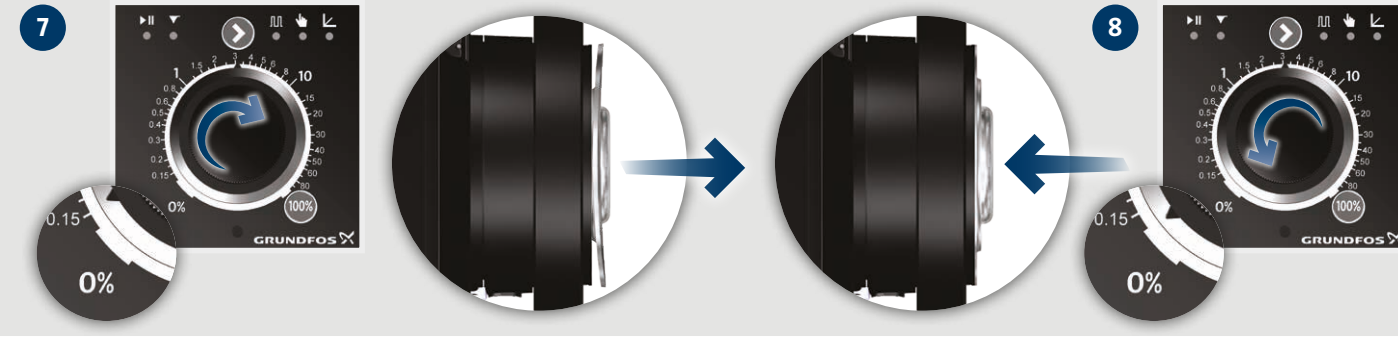
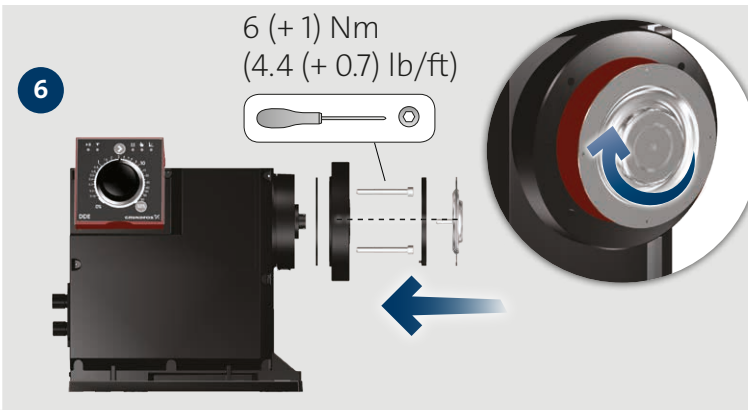
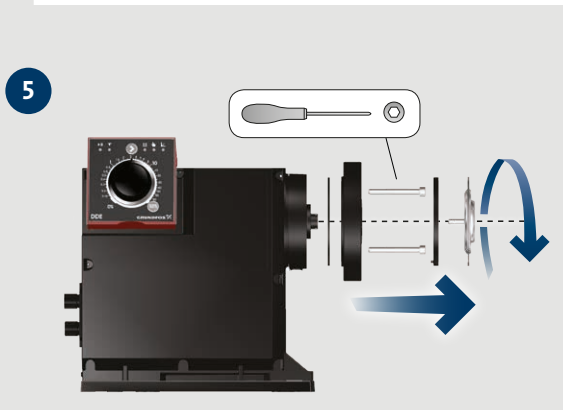
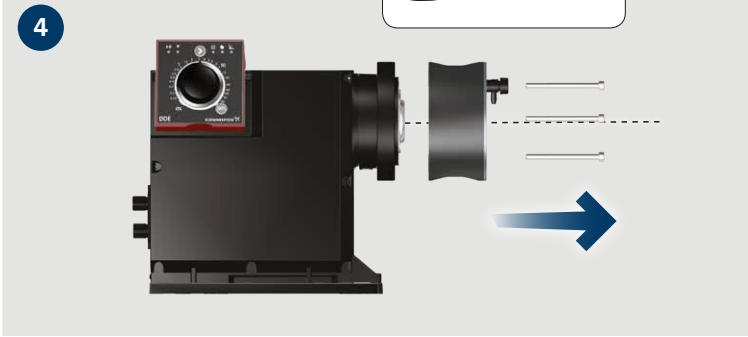
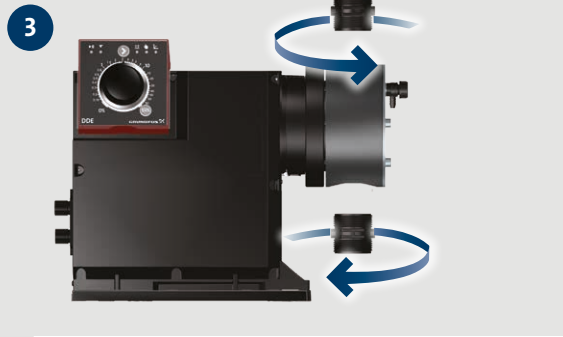

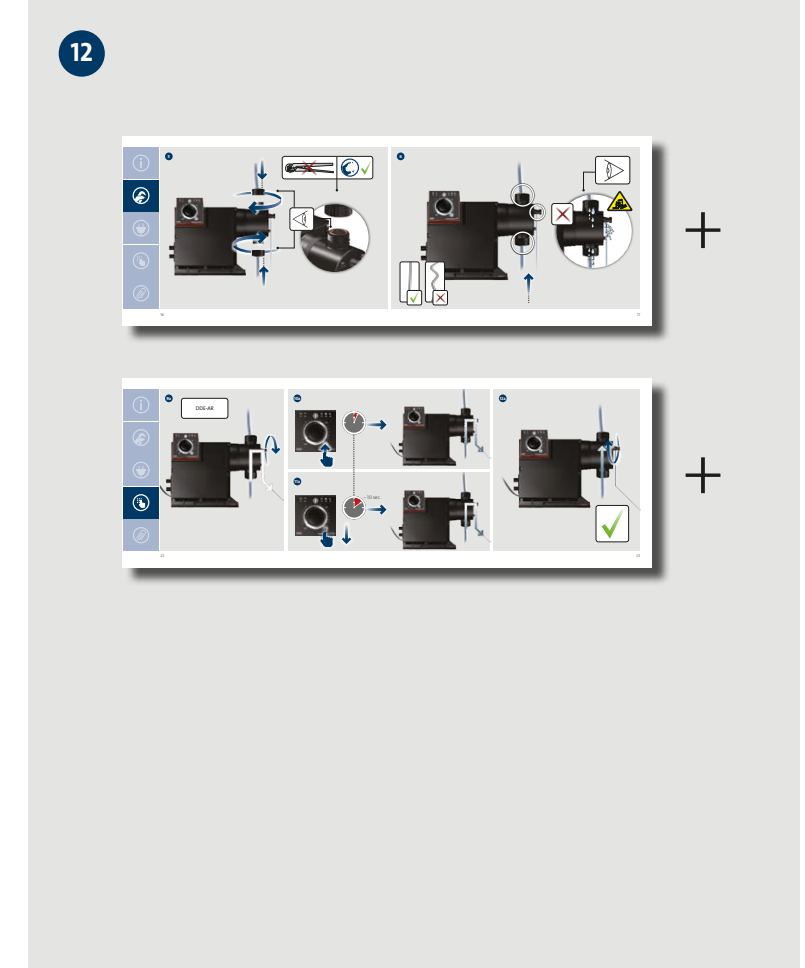
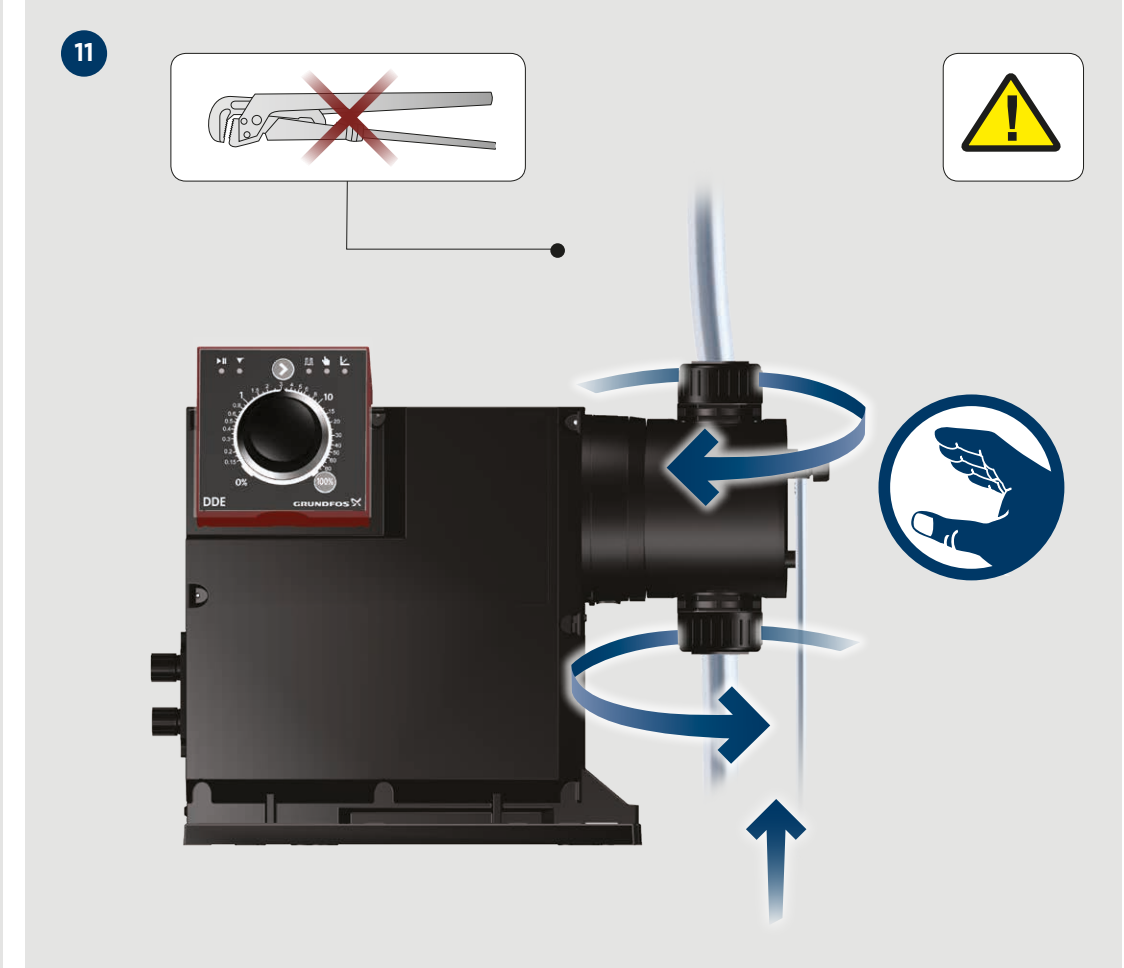
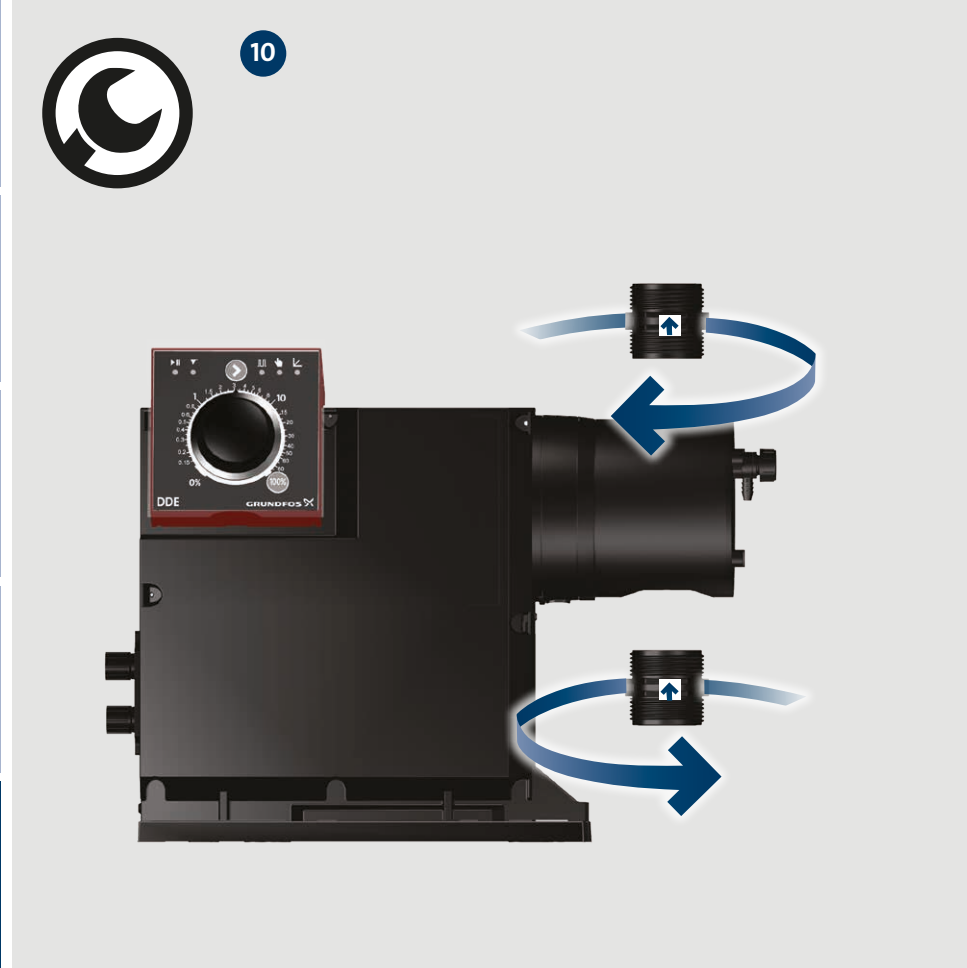
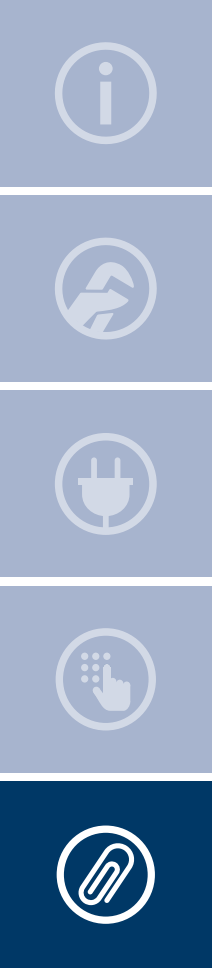

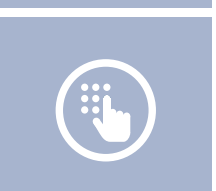
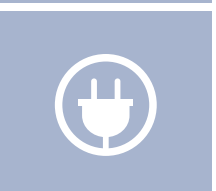

be think innovate

98982093 1018

ECM: 1242871

GRUNDFOS Holding A/S
Poul Due Jensens Vej 7
DK-8850 Bjerringbro
Tel: +45 87 50 14 00
www.grundfos.com

Pumpland.ru

GRUNDFOS 

Trademarks displayed in this material, including but not limited to Grundfos, the Grundfos logo and "be think innovate" are registered trademarks owned by The Grundfos Group. All rights reserved.
© 2018 Grundfos Holding A/S, all rights reserved.