

Hydro Multi-E

CR(I)E

 GRUNDFOS
PRESSURE BOOSTING



be think innovate

GRUNDFOS 



1

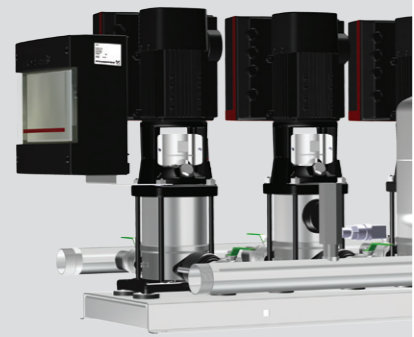

2

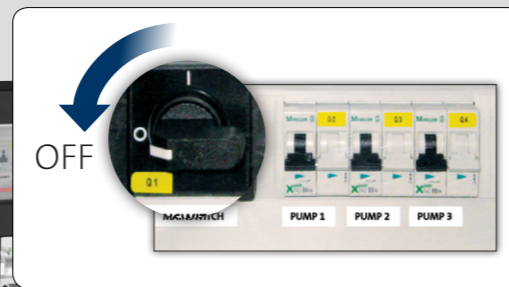

3

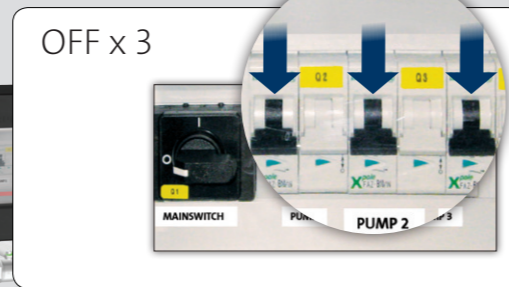

4

Factory settings	
Date	Setting (SP)

Customer settings		
Date	Setting (SP)	Initials



$P = 0.7 \times SP$

$P = 0 \text{ bar}$

SP

Green checkmark



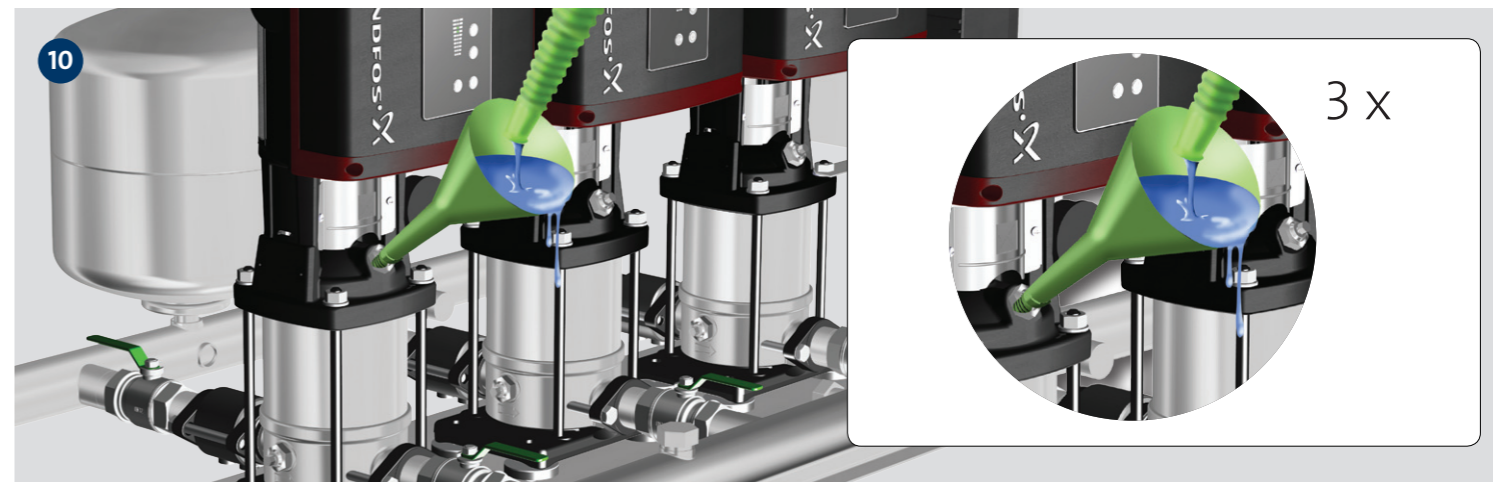
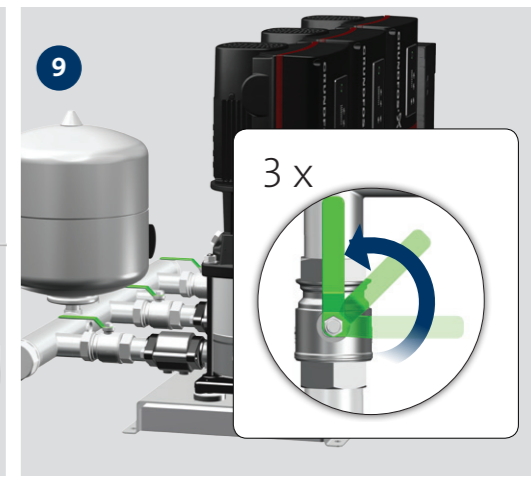
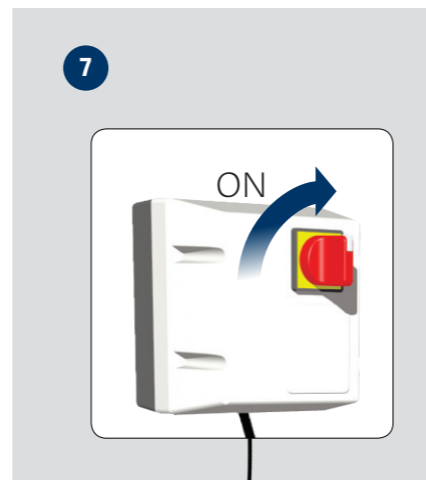
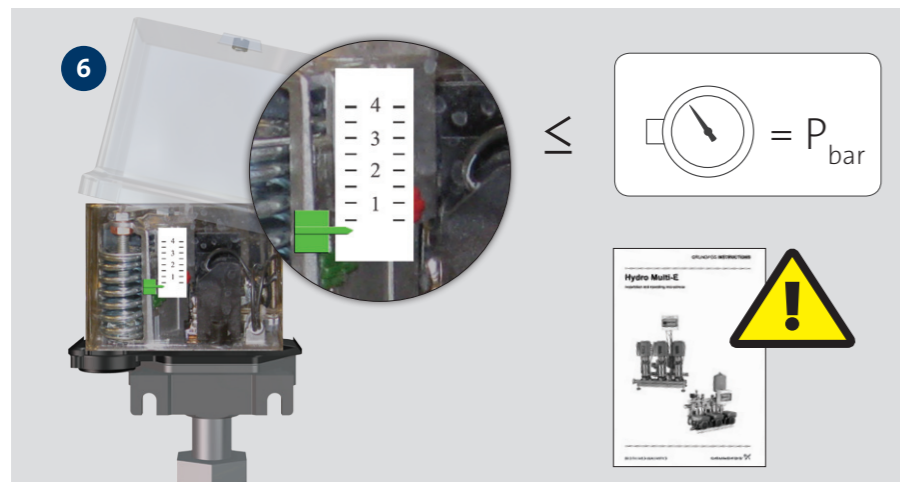
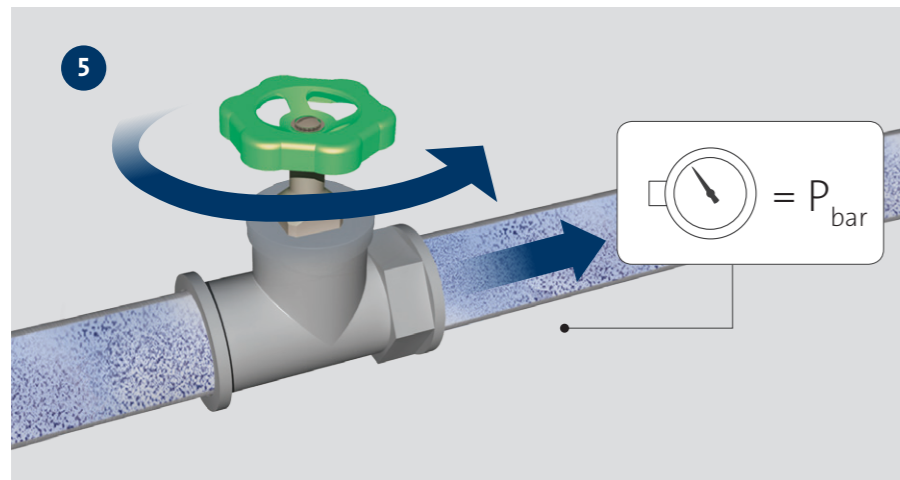



11

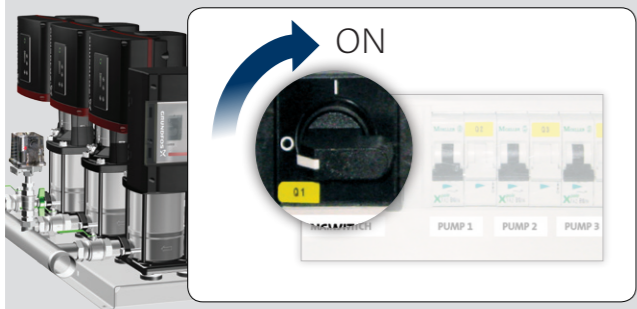

12

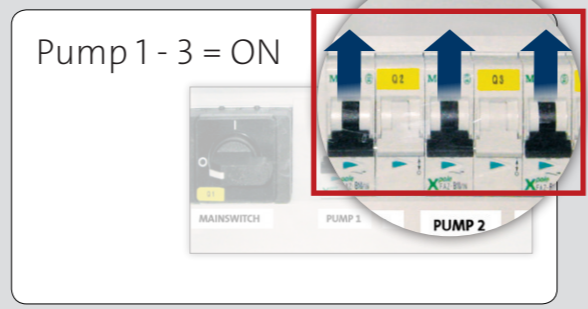

15

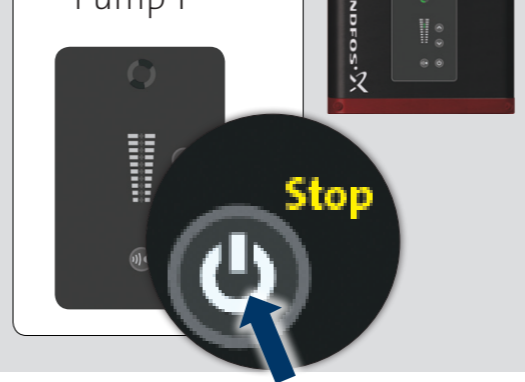

16



13

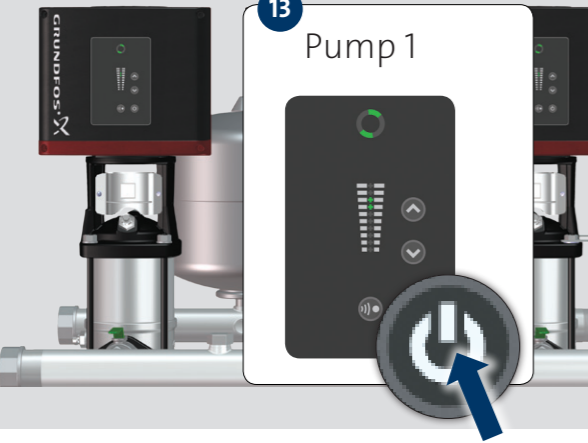

14

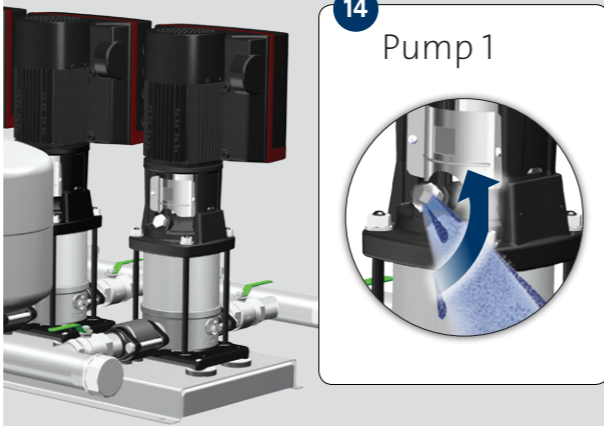

17

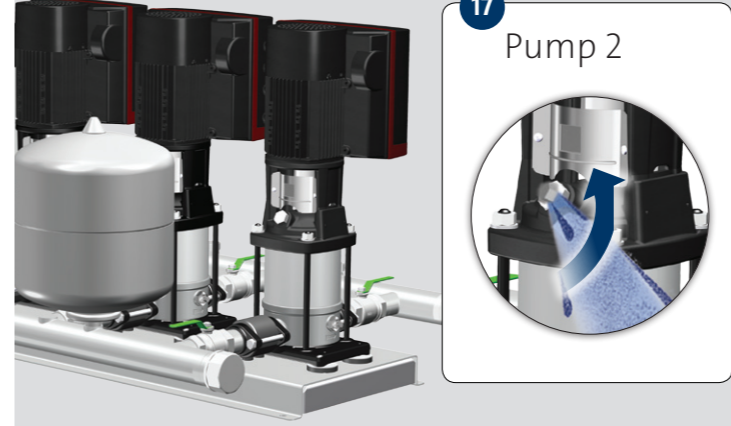

18

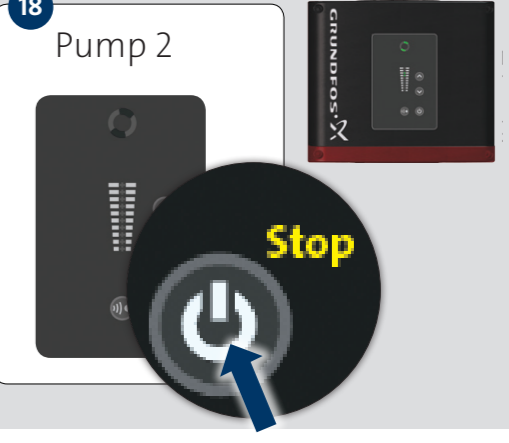



24

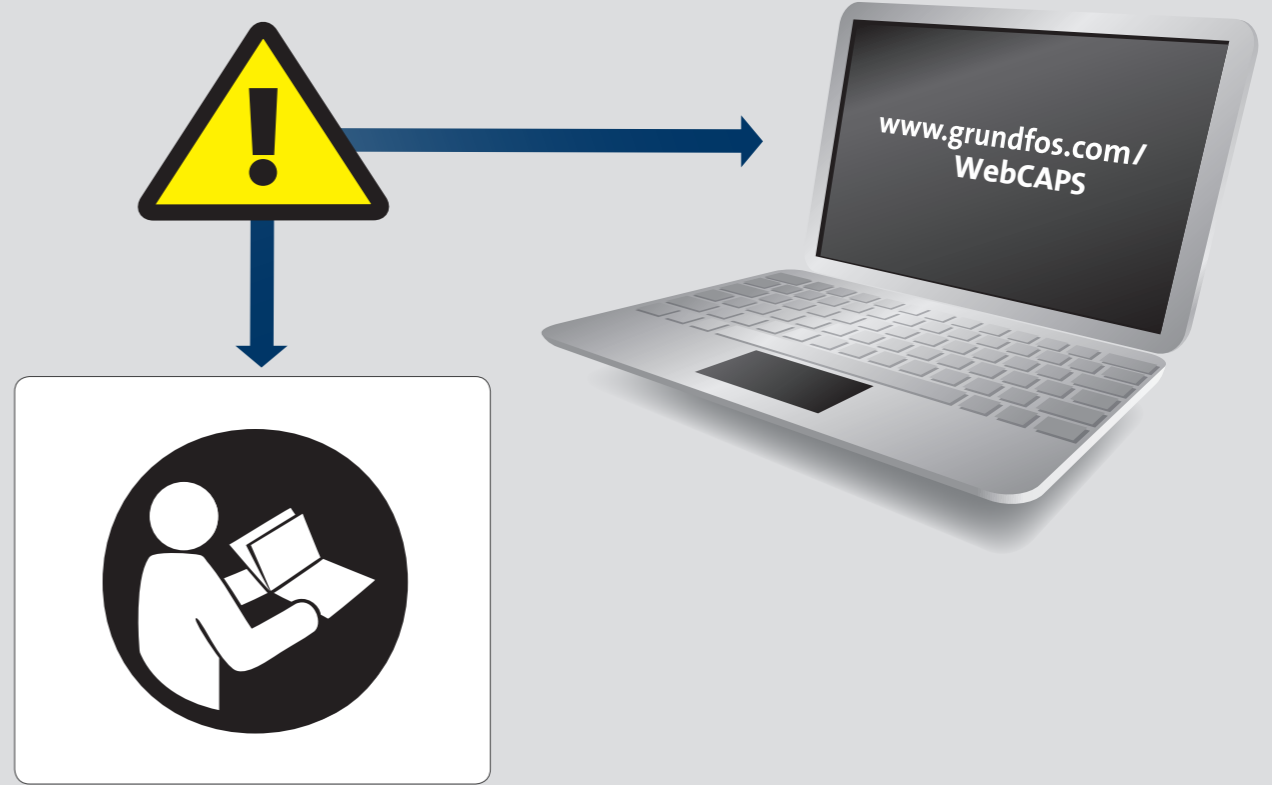

98477592 0713

ECM: 1117625

be think innovate

Pumpland.ru

GRUNDFOS 

The name Grundfos, the Grundfos logo, and the payoff be think innovate, are registered trademarks owned by Grundfos Holding A/S or Grundfos A/S, Denmark. All rights reserved worldwide.